



ELIXIR SURGICAL  
الإكسير سرجكل

Bringing Reliability,  
Innovation and  
Value To  
Healthcare

## Profile

Elixir Surgical believes in bringing Reliability, Innovation and Value to the healthcare sector. And today as one of the trusted Surgical and Dental instrument companies; we continue our commitment to advancing instrument performance by supporting these products with world class service, support, education and peer communities.











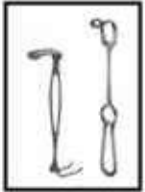

Elixir Surgical is much more than a supplier of high precision Medical Devices: a partner who listens carefully and contributes ideas, who understands the customers' needs and requirements and provides for them on a level so that they can perform at the highest level.

This assurance is rooted in the knowledge that all instruments are precision designed and produced under strict quality control procedures. A large number of new orders delivered every year to the medical facilities across the world testify to the high level of confidence by the healthcare professionals in our products. Our systems and quality are guided by CE Class I Device certification, ISO: 9001 & ISO: 13485 accreditation.

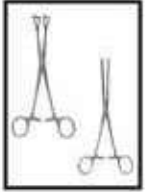
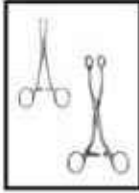
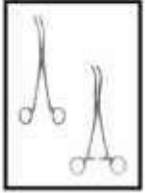

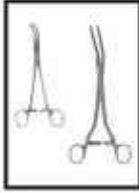





All Instruments are made from durable, surgical-grade stainless steel, crafted to demanding standards and tolerances. Each product is rigorously tested for reliability and performance parameters. The premier OR-Grade Instruments are designed to meet the Exacting Standards and come with a guarantee against Cracking, Breaking, Pitting and Rusting.

Elixir Surgical is headquartered in Pakistan, and prides itself on the highly skilled staff to produce accurate hand-crafted. As such, we are committed to 'raising the bar' in every aspect of our business, from customer service to product development. This commitment takes the form of superior products that perform impeccably and to experts requirements.

## Table Of Contents

Diagnostic, Anaesthesia and other instruments	Page Seite 1 - 10		Probes, Pocket Instruments sets	Page Seite 66 - 68	
Scalpels, knives and Scalpel Handles	11 - 14		Wound Retractors	69 - 80	
Scissors	15 - 31		Self-Retaining Retractors, Abdominal Retractors	81 - 85	
Dissecting-and Tissue Forceps	32 - 42		Abdominal Surgery Intestinal-and Rectal Instruments	86 - 93	
Sponge, Dressing and Tissue Grasping Forceps Towel Clamps	43 - 48		Gall Bladder-, Liver-and Spleen Instruments	94 - 96	
Vessel Clips, Bulldog Clamps Haemostatic Forceps	49 - 57		Genito-Urinary Instruments and Trocars	97 - 100	
Ligature, Hysterectomy and Compression Forceps Vaginal Clamps	58 - 60		Vaginal Specula and Uterine Dilators	101 - 106	
Needle Holders, Suture Instruments	61 - 65		Uterine Probes, Uterine Dressing-, Polypus-and Ovum Forceps	107 - 109	

# Table Of Contents

	Page Seite			Page Seite	
Biopsy Instruments and Curettes	110 - 116		Suction Instruments	158 - 166	
Obstetrics and Tracheotomy	117 - 119				
Cardiovascular-and Thoracic Surgery	120 - 128				
Bone Punches, Rongeurs	129 - 134				
Elevators, Bone Levers, Raspatories, Bone Files, Bone Curettes	135 - 139				
Mallets, Chisels and Gouges	140 - 141				
Bone Holding Forceps, Bone Rongeurs, Bone Cutting Forceps	142 - 146				
Plaster Instruments	147 - 157				

## Percussion Hammers and Aesthesiometers



# Stethoscopes



**01-110**  
**PINARD (Aluminum)**  
 Size: 155 mm.

1/2



**01-111**  
**wooden**  
 Size: 145 mm

1/2



**01-112**  
**BOWLES**  
 Stethoscope  
 with diaphragm

1/4



**01-113**  
**ANESTOPHON**

1/2



**01-114**  
**FORD-BOWLES**  
 Dual chest piece  
 with two outlets

1/4



**01-115**  
**BOWLES**

1/4

## Head Mirrors and Head Bands



**01-116**  
 ZIEGLER Ø 90mm  
 head mirror only  
 with rubber coating



**01-117**  
 ZIEGLER Ø 90mm  
 head mirror only  
 with metal coating



**01-118**  
 ZIEGLER  
 head band of plastic black

**01-119**  
 ZIEGLER  
 head band of plastic white



**01-120**  
 MURPHY  
 head band of celluloid, white



**01-121**  
 head band of plastic,  
 white, soft pattern



**01-122**  
 head mirror with black  
 plastic head band.

# Tongue Depressors

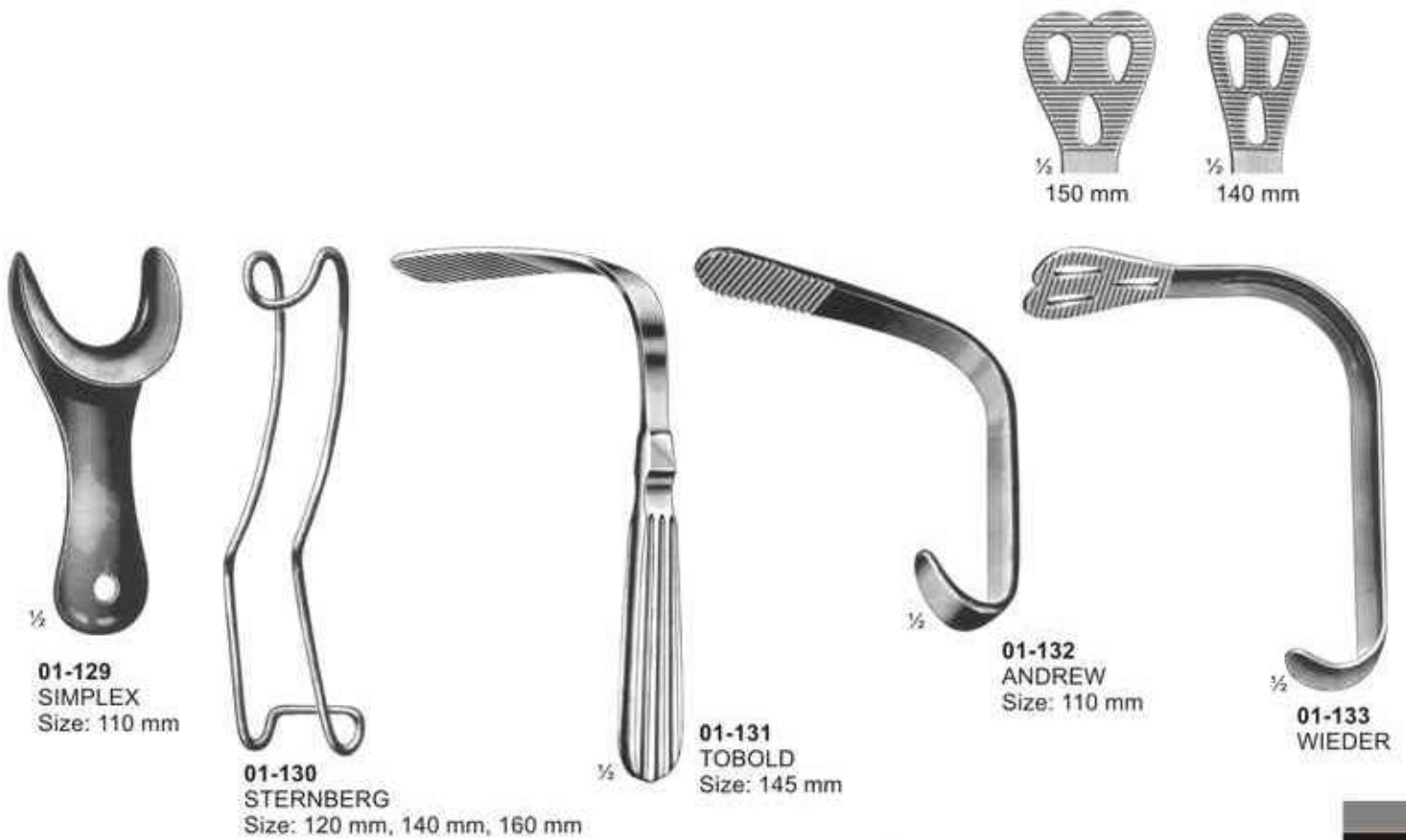
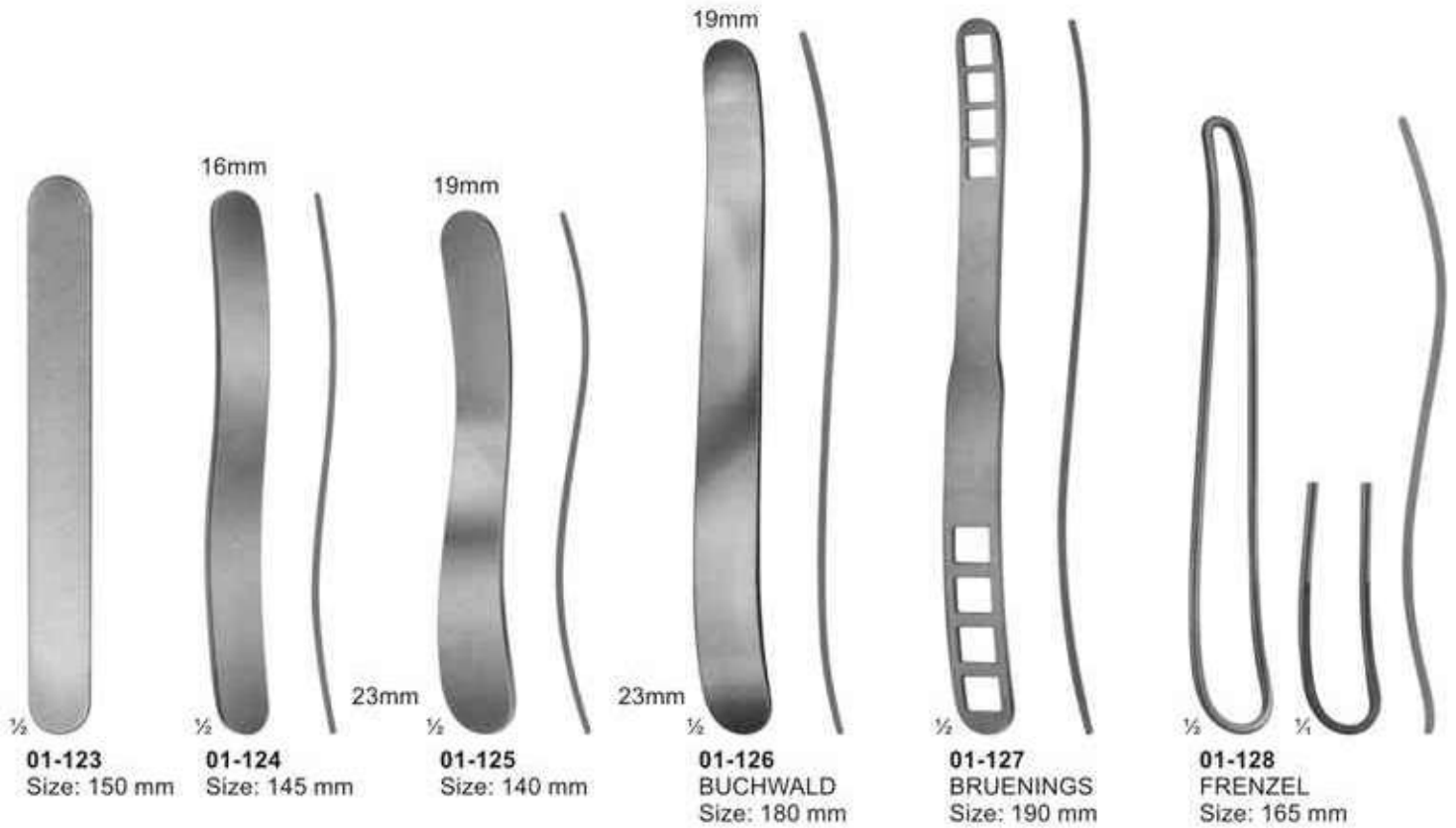



## Instruments for Anaesthesia and Tongue Forceps



1/2  
**01-134**  
**SCHIMMELBUSCH**  
Ether mask



1/2  
**01-135**  
**HEISTER**  
Mouth gag  
Size: 130 mm



1/2  
**01-136**  
**FERGUSSON-ACKLAND**  
Mouth gag  
Size: 145 mm



1/2  
**01-137**  
**DENHARDT**  
Mouth gag with silicon  
inserts, interchangeable  
Size: 125 mm



1/2  
**01-138**  
**ROSER KOENIG**  
Mouth gag  
Size: 160 mm, 185 mm

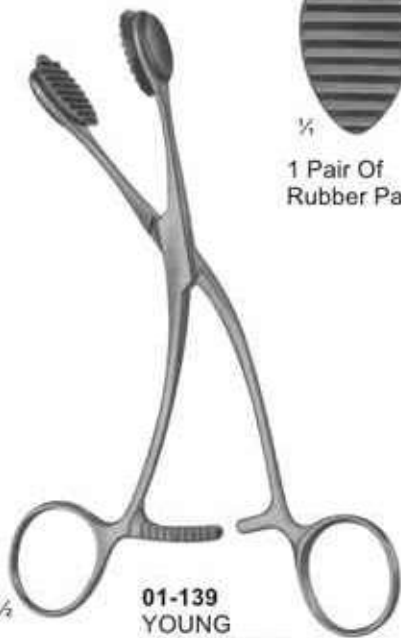

1/2  
1 Pair Of  
Rubber Pads

1/2  
**01-139**  
**YOUNG**  
Size: 165 mm

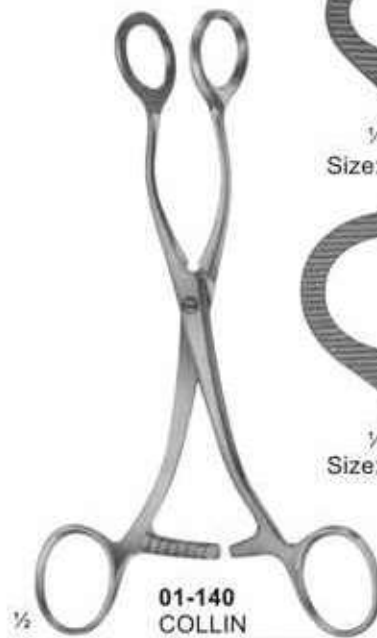

1/2  
Size: 160 mm



1/2  
Size: 170 mm

1/2  
**01-140**  
**COLLIN**  
Size: 160 mm,  
170 mm



1/2  
**01-141**  
**HEYWOOD-SMITH**  
modif. Size: 215 mm

## Blood Lancets and Laryngeal Mirrors



**01-142**  
FRANCKE  
Automatic blood lancet

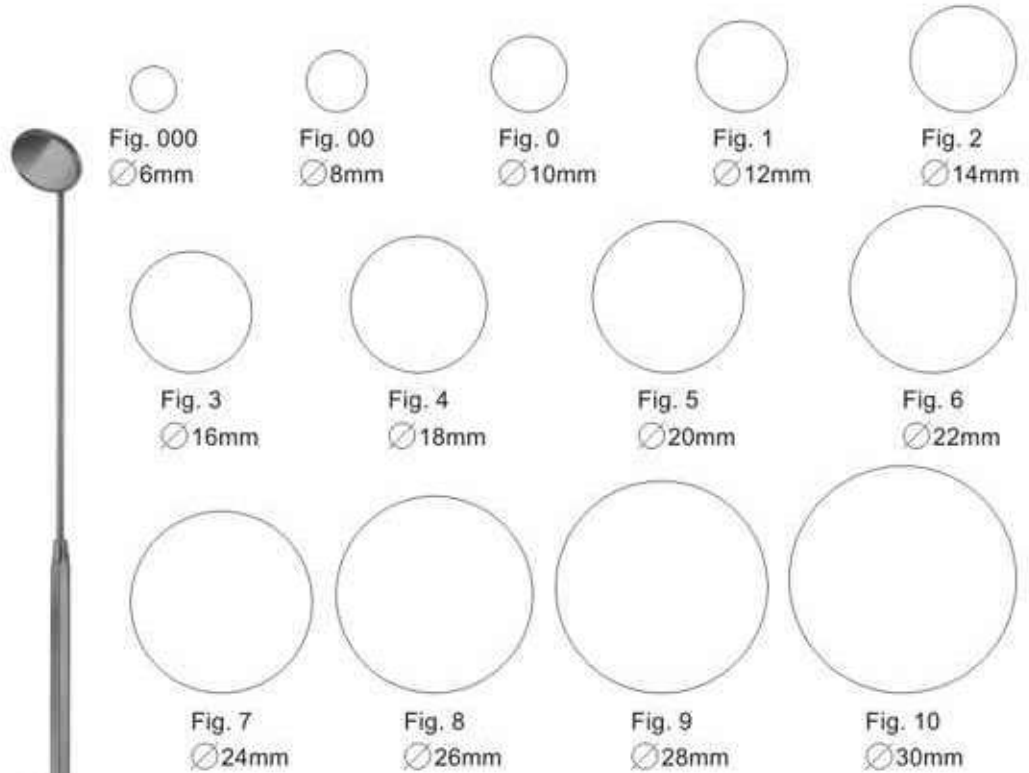

**01-143**  
Laryngeal mirrors with  
hexagonal handle  
Size: 180 mm



**01-148**  
Spare mirrors only  
Size: 12 mm



**01-149**  
Spare mirrors only  
Size: 14 mm



**01-144**  
KOLLE  
Microscopic Needle  
Holder with plastic  
handle.  
Size: 240 mm



**01-145**  
Mirror handle  
Size: 110 mm



**01-146**  
Mirror handle  
Size: 105 mm



**01-147**  
MICHEL  
Rhinoscopic mirrors with  
interchangeable mirror inserts  
Size: 250 mm

## Laryngoscope and Diagnostic Sets



**01-150**  
 Infants  
 Size: 150 mm



**01-151**  
 Children  
 Size: 200 mm



**01-152**  
 Adults  
 Size: 250 mm



**01-154**



**01-150 - 152**  
 MAGILL



**01-153**  
 Medium battery handle  
 only, 25 mm diam.



**01-153-A**  
 Spare bulb  
 2.7 volt, for  
 otoscopes



**01-153-B**  
 Spare bulb  
 2.6 volt, for  
 ophthalmoscopes



**01-155**



**01-156**  
 Otoscope set, consists of  
 battery handle without batteries,  
 3 ear specula, 1 bulb in valvet lined case



**01-157**  
 Diagnostic set, otoscope with three specula,  
 nasal speculam, lamp holder, two laryngeal  
 mirrors, tongue blade holder

## Laryngoscopes



**01-158**  
**MILLER**  
Laryngoscope set, consists of battery handle ( without battery )  
with four miller laryngoscope blades

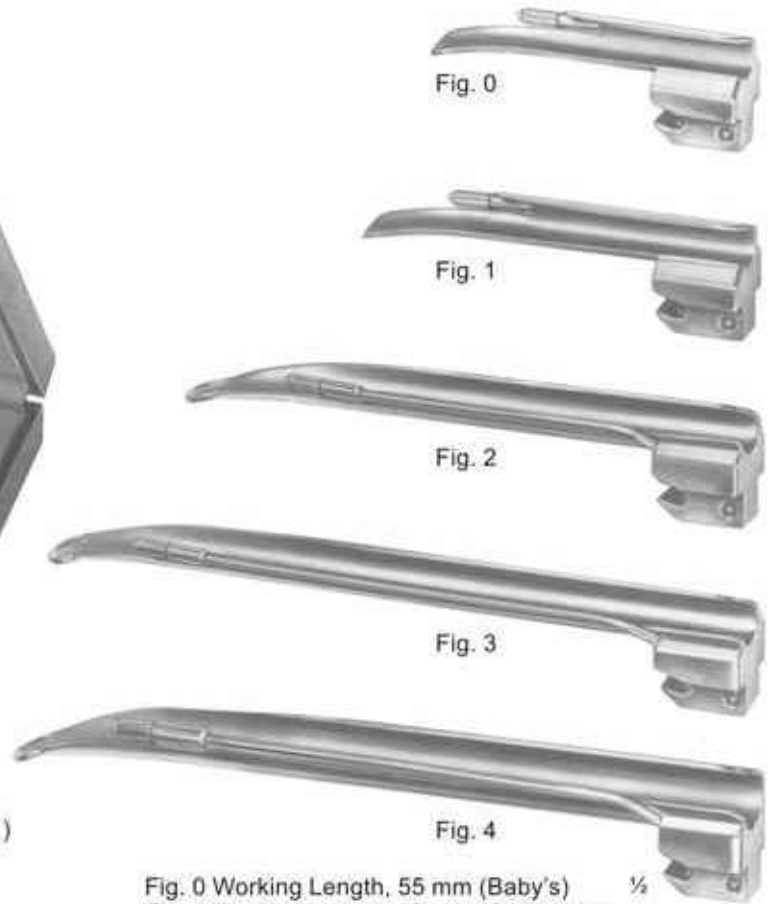

Fig. 0 Working Length, 55 mm (Baby's)  
Fig. 1 Working Length, 80 mm (Children's)  
Fig. 2 Working Length, 130 mm (Adolescent's)  
Fig. 3 Working Length, 170 mm (Women's)  
Fig. 4 Working Length, 180 mm (Men's)



**01-159**  
**GUEDEL-NEGUS**  
Laryngoscope set, consists of battery handle ( without battery )  
with four miller laryngoscope blades

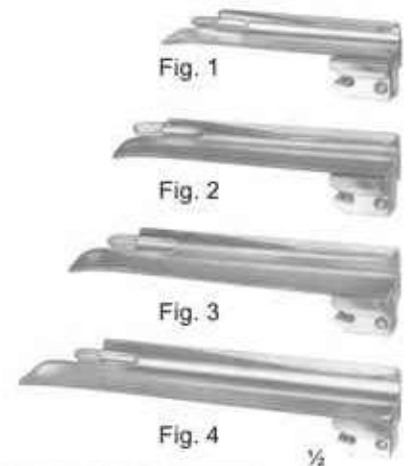

Fig. 1 Working Length, 70 mm (Children's)  
Fig. 2 Working Length, 90 mm (Adolescent's)  
Fig. 3 Working Length, 110 mm (Women's)  
Fig. 4 Working Length, 135 mm (Men's)

# Laryngoscopes



**01-160**  
 McINTOSH  
 Laryngoscope Set, Consists Of Battery Handle ( Without Battery )  
 With Three McIntosh Blades, Fig. 1, Fig. 2, Fig. 3

**01-161**  
 McINTOSH  
 Laryngoscope Set, Consists Of Battery Handle ( Without Battery )  
 With Five McIntosh Blades, Fig. 0, Fig. 1, Fig. 2, Fig. 3, Fig. 4

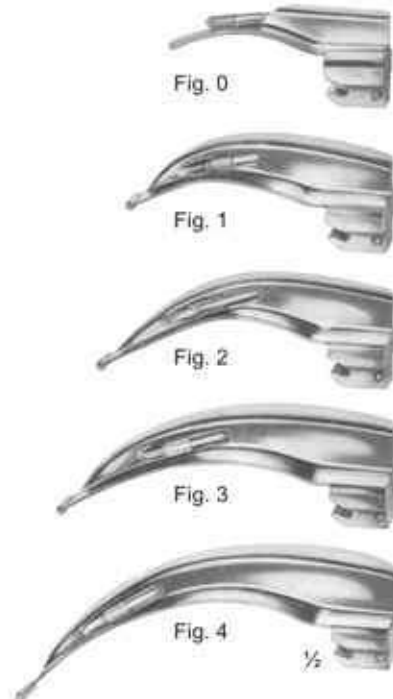

01-161 A Fig. 0 Working Length, 55 mm (Baby's)  
 01-161 B Fig. 1 Working Length, 75 mm (Children's)  
 01-161 C Fig. 2 Working Length, 90 mm (Adolescent's)  
 01-161 D Fig. 3 Working Length, 110 mm (Women's)  
 01-161 E Fig. 4 Working Length, 135 mm (Men's)

**01-162**  
 FOREGGER  
 Laryngoscope Set, Consists Of  
 Battery Handle ( Without Battery )  
 With Three Foregger Blades,  
 Fig. 1, Fig. 2, Fig. 3.



**01-163**  
 FOREGGER  
 Laryngoscope Set, Consists Of  
 Battery Handle ( Without Battery )  
 With Four Foregger Blades,  
 Fig. 1, Fig. 2, Fig. 3, Fig. 4,

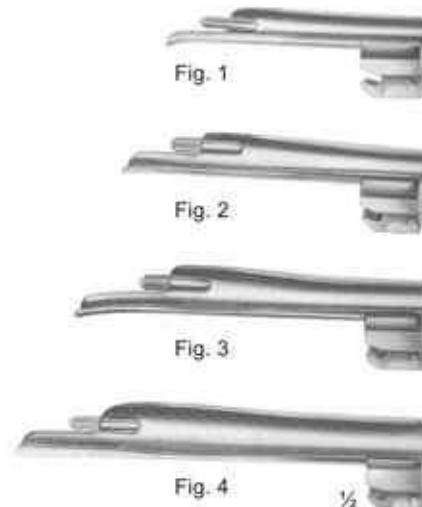

01-162 A Fig. 1 Working Length, 70 mm (Children's)  
 01-162 B Fig. 2 Working Length, 90 mm (Adolescent's)  
 01-162 C Fig. 3 Working Length, 110 mm (Women's)  
 01-162 D Fig. 4 Working Length, 135 mm (Men's)



**01-164**  
 Fiber Optic  
 Battery Handle  
 30mm diam.



**01-165**  
 Fiber Optic  
 Battery Handle  
 18mm diam.



**01-166**  
 Replacement Lamp  
 ( Krypton ) 2.5 V



**01-167**  
 Replacement Lamp  
 ( Halogen ) 2.5 V

## Examination & Measuring Instruments



**01-168**  
Caliper Of Aluminium  
Graduated in mm & inches  
up to 180mm  
Measuring Range up to 139mm



**01-169**  
VERNIER  
Universal Caliper Of Steel  
Graduated in mm & inches  
up to 180mm  
Measuring Range up to 120mm  
with Vernier in 1/10mm & 1/16"



**01-170**  
CARROLL  
Size: 145 mm  
Finger Goniometer.



**01-171**  
TOWNLEY  
Graduated in  
mm & inches  
Size: 115 mm



**01-172**  
COLLIN  
Druck Pressure 72 kg  
Size: 125 mm



**01-173**  
BERTILLON  
Caliper For Measuring The Head  
Size: 320 mm



**01-174**  
CASTROVIEJO  
Caliper  
Size: 75mm



**01-175**  
MOLTGEN  
Goniometer



**01-176**  
Size: 150 mm



**01-177**  
Size: 500 mm



# Dissecting Knives



02-101 - 110  
Fig. 1 - 10



02-101  
Fig. 1  
30 mm



02-102  
Fig. 2  
36 mm



02-103  
Fig. 3  
40 mm



02-104  
Fig. 4  
45 mm



02-105  
Fig. 5  
50 mm



02-106  
Fig. 6  
27 mm



02-107  
Fig. 7  
35 mm



02-108  
Fig. 8  
40 mm



02-109  
Fig. 9  
47 mm



02-110  
Fig. 10  
50 mm

## Amputating Knives, Cartilage Knives and Autopsy Knives



LISTON  
**02-111**  
Size: 130 mm  
**02-112**  
Size: 160 mm  
**02-113**  
Size: 190 mm  
**02-114**  
Size: 200 mm

**02-115**  
CATLIN  
Size: 160 mm  
Blade length  
Amputating  
Knives

**02-116**  
LANGENBECK  
Size: 120 mm  
Blade length  
Flap Knives

**02-117**  
Size: 110 mm  
Blade length  
Interosseous  
Knives

**02-118**  
Size: 55 mm  
Blade length  
with raspatory,  
Wooden handle

**02-119**  
Size: 70 mm  
Blade length  
Wooden handle

**02-120**  
Size: 80 mm  
Blade length  
Metal handle

**02-121**  
Size: 195 mm  
Blade length  
Metal handle

Blade length  
Amputating Knives



# Cone Knives, Myomatome, Trigeminal and Tonsil Knives



**02-122**  
AYRE  
Size: 235 mm  
Cone Knife

**02-123**  
Size: 230 mm  
Cone Knife

**02-124**  
SEGOND  
Size: 270 mm  
Myomatome

**02-125**  
OLIVECRONA  
Size: 205 mm  
Trigeminal  
Knife

**02-126**  
Size: 230 mm  
Trigeminal  
Knife

**02-127**  
FOWLER  
Size: 200 mm  
Tonsil Knife

**02-128**  
ABRAHAM  
Size: 215 mm  
Tonsil Knife

**02-129**  
BRUNINGS  
Size: 215 mm  
Tonsil Knife

## Scalpel Handles



- |   |                                   |                                   |   |   |                                   |                                       |                                   |   |   |
|---|-----------------------------------|-----------------------------------|---|---|-----------------------------------|---------------------------------------|-----------------------------------|---|---|
| 02-130<br>STANDARD<br>No. 3<br>Solid<br>12 cm | 02-131<br>No. 3<br>Solid<br>12 cm | 02-132<br>No. 3<br>Solid<br>12 cm | 02-133<br>No. 3 L<br>Straight<br>Solid<br>21.5 cm | 02-134<br>No. 3 L<br>Angled<br>Solid<br>21 cm | 02-135<br>No. 7<br>Solid<br>16 cm | 02-136<br>No. 7 K<br>Solid<br>12.5 cm | 02-137<br>Hollow-Round<br>15.5 cm | 02-138<br>No. 3<br>Straight<br>Solid,<br>Round<br>14.5 cm | 02-139<br>No. 3<br>Angled<br>Solid,<br>Round<br>14 cm |
|---|-----------------------------------|-----------------------------------|---|---|-----------------------------------|---------------------------------------|-----------------------------------|---|---|

## Micro Scissors (Spring Type) with Flat Handles

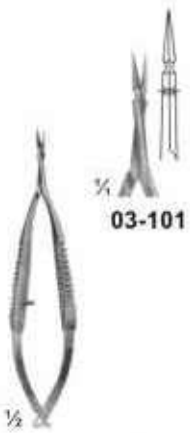

**03-101 - 103**  
**VANNAS**  
 Size: 85 mm



**03-104 - 105**  
**CASTROVIEJO**  
 Size: 95 mm



**03-106**  
**NOYES**  
 Size: 125 mm

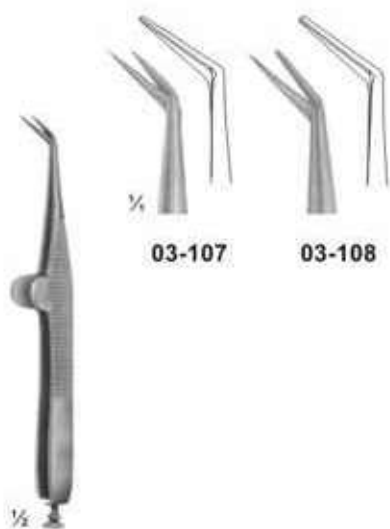

**03-107 - 108**  
**WECKER**  
 Eye scissor  
 Size: 110 mm



**03-109**  
**CASTROVIEJO**  
 Eye scissor  
 Size: 115 mm

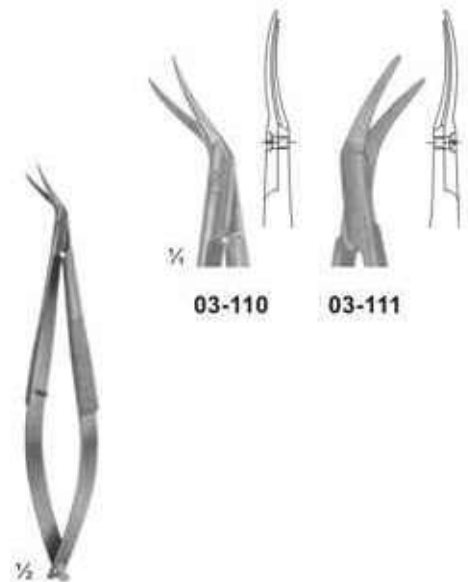

**03-110 - 111**  
**CASTROVIEJO**  
 Eye scissor  
 Size: 110 mm

## Micro Scissors (Spring Type) with Flat Handles

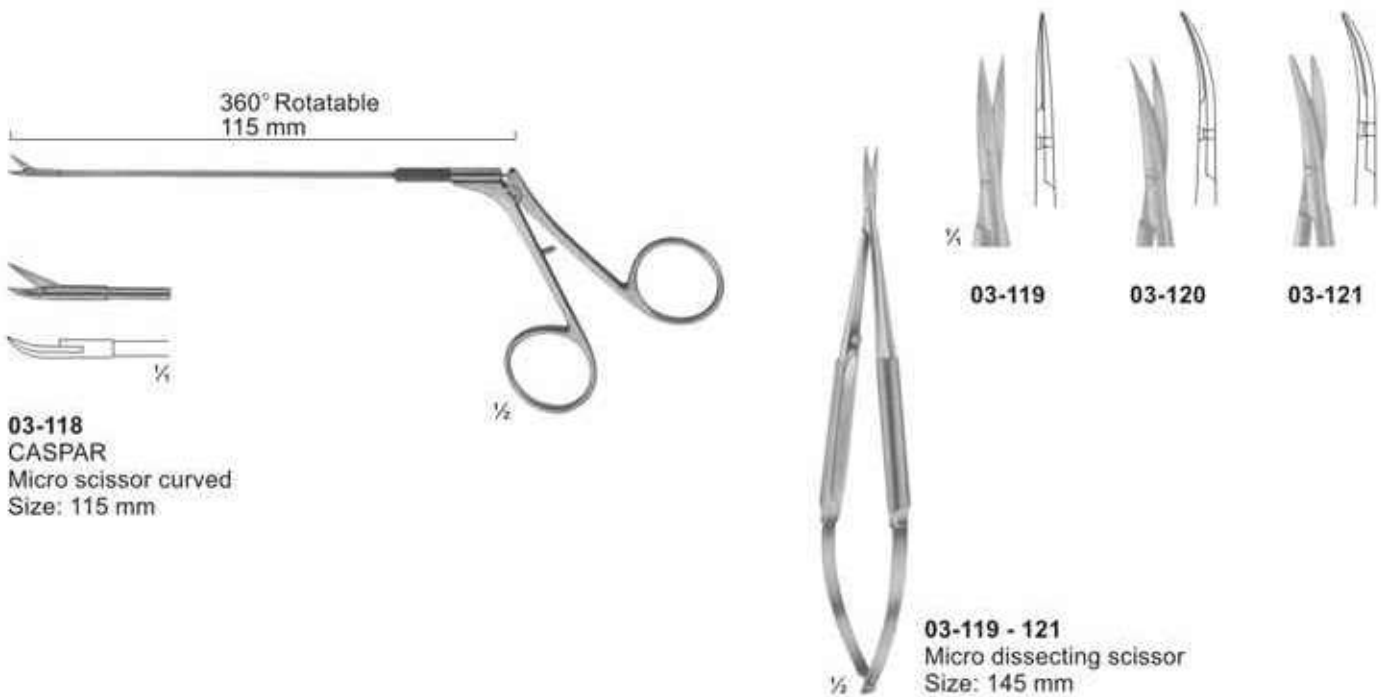
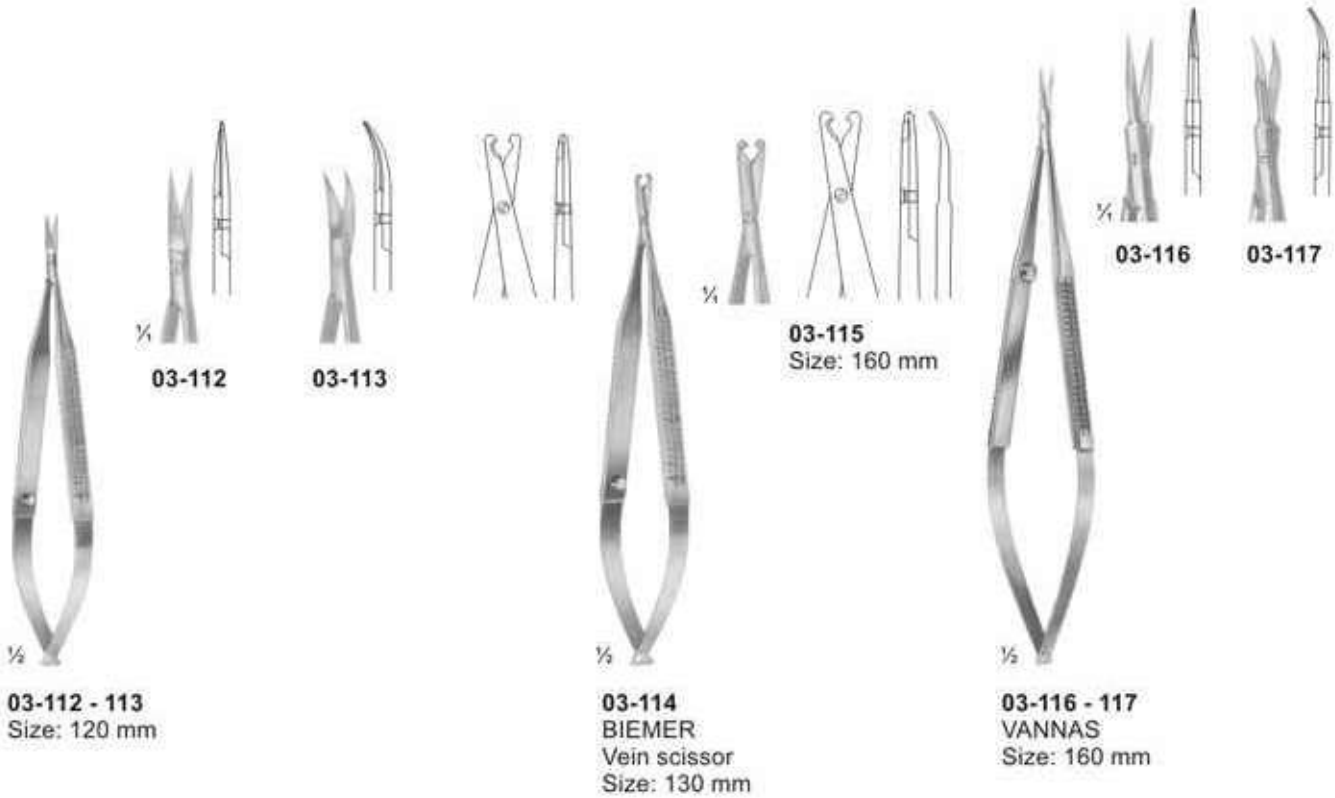

## Micro Scissors (Spring Type) bayonet-Shaped



$\frac{1}{2}$ 
  
**03-122**
  
**YASARGIL**
  
 Size: 245 mm



$\frac{1}{2}$ 
  
**03-123**
  
**45**



$\frac{1}{2}$ 
  
**03-124**
  
**45**



$\frac{1}{2}$ 
  
**03-123 - 124**
  
 laterally angled
   
 Size: 200 mm



$\frac{1}{2}$ 
  
**03-125**
  
 laterally angled
   
 Size: 190 mm



$\frac{1}{2}$ 
  
**03-126**



$\frac{1}{2}$ 
  
**03-127**



$\frac{1}{2}$ 
  
**03-126 - 127**
  
**YASARGIL**
  
 Size: 225 mm

## Delicate Scissors



03-128

03-129

03-128 - 129  
Size: 90 mm

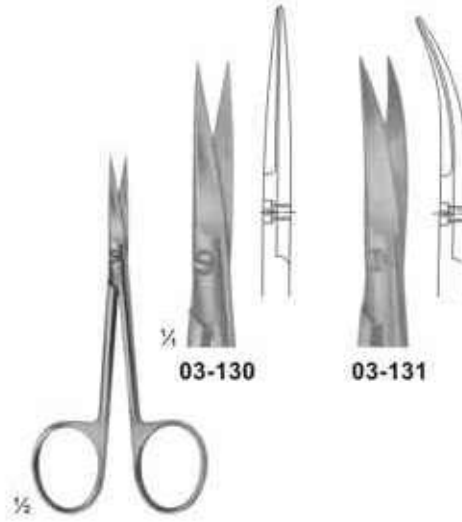

03-130

03-131

03-130 - 131  
Size: 95 mm

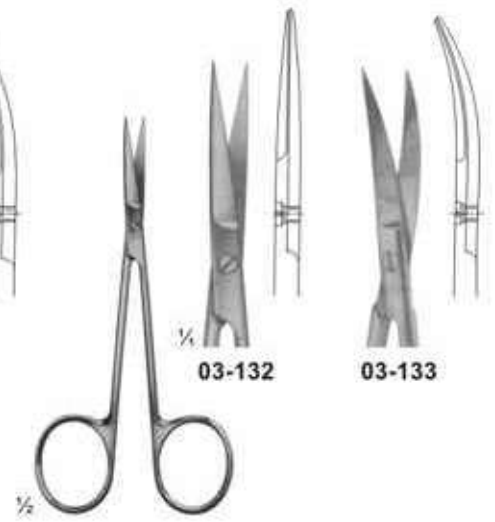

03-132

03-133

03-132 - 133  
Size: 105 mm

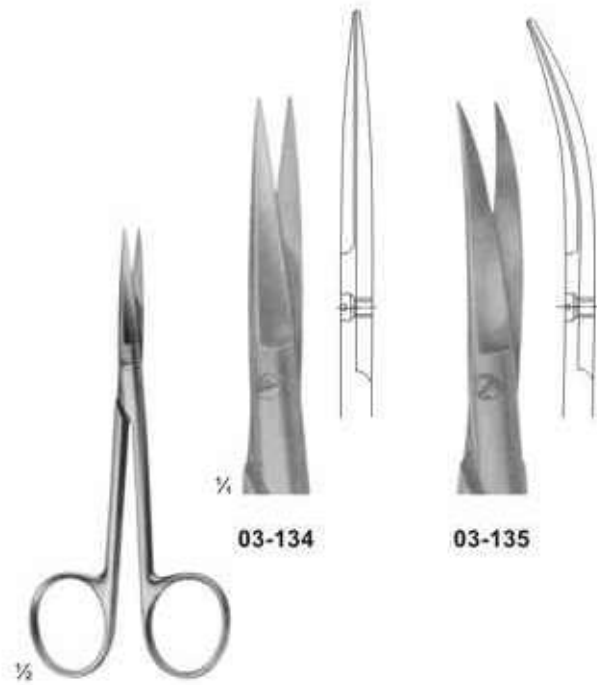

03-134

03-135

03-134 - 135  
Size: 120 mm



03-136

03-137

03-136 - 137  
Size: 115 mm

## Delicate Scissors



03-138 - 140  
Size: 120 mm



03-138

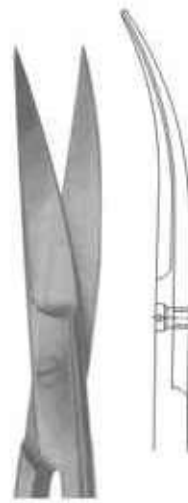

03-139



03-140



03-141 - 144  
Size: 130 mm

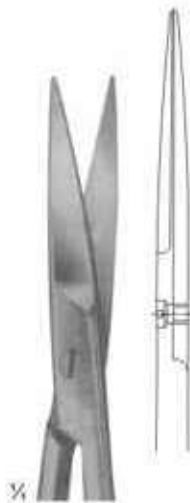

03-141



03-142

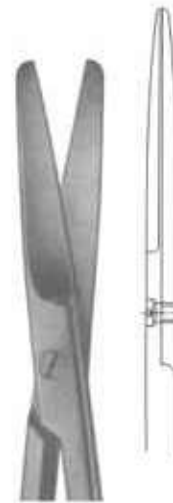

03-143



03-144

# Surgical Scissors



**03-145 - 153 (Standard types)**  
 03-145 ( 105 mm )  
 03-146 ( 115 mm )  
 03-147 ( 130 mm )  
 03-148 ( 145 mm )  
 03-149 ( 150 mm )  
 03-150 ( 165 mm )  
 03-151 ( 175 mm )  
 03-152 ( 185 mm )  
 03-153 ( 200 mm )

**03-145**  
 Size: 105 mm

**03-153**  
 Size: 200 mm



**03-154 - 160 (Standard types)**  
 03-154 ( 115 mm )  
 03-155 ( 130 mm )  
 03-156 ( 145 mm )  
 03-157 ( 150 mm )  
 03-158 ( 165 mm )  
 03-159 ( 175 mm )  
 03-160 ( 185 mm )

**03-154**  
 Size: 115 mm

**03-160**  
 Size: 185 mm

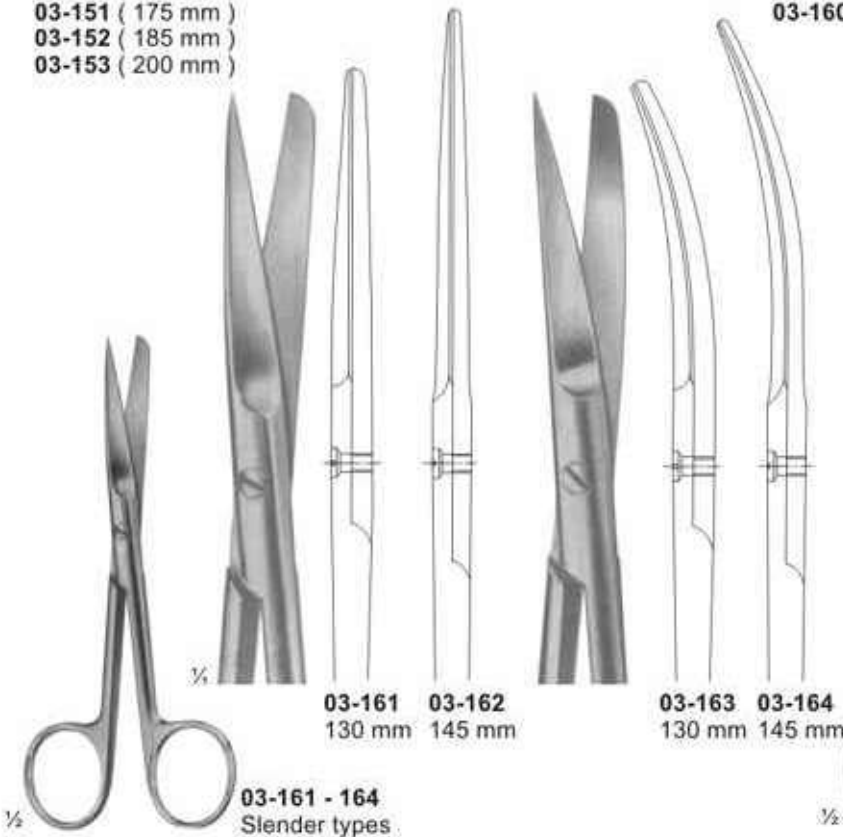

**03-161**  
 130 mm

**03-162**  
 145 mm

**03-163**  
 130 mm

**03-164**  
 145 mm

**03-161 - 164**  
 Slender types

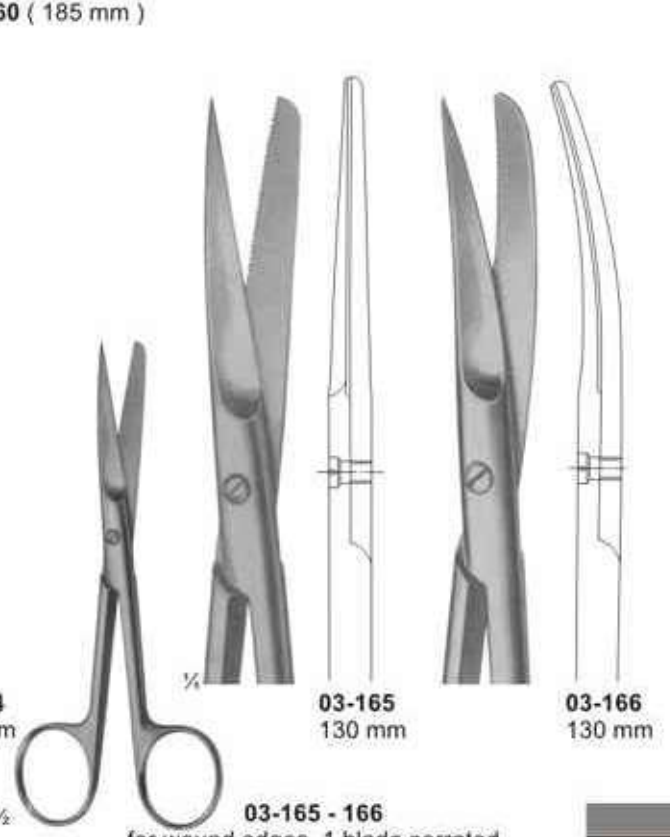

**03-165**  
 130 mm

**03-166**  
 130 mm

**03-165 - 166**  
 for wound edges. 1 blade serrated



# Surgical Scissors



**03-167 - 169**  
DEAVER  
with flat lock

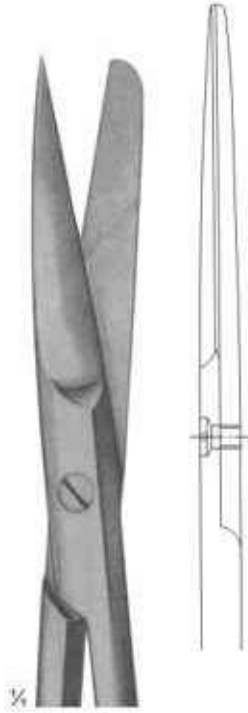

**03-167**  
Size: 145 mm

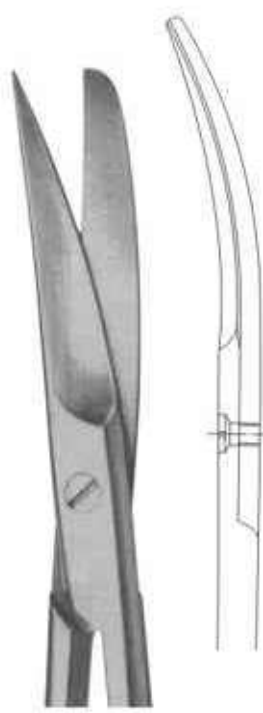

**03-168**  
Size: 145 mm

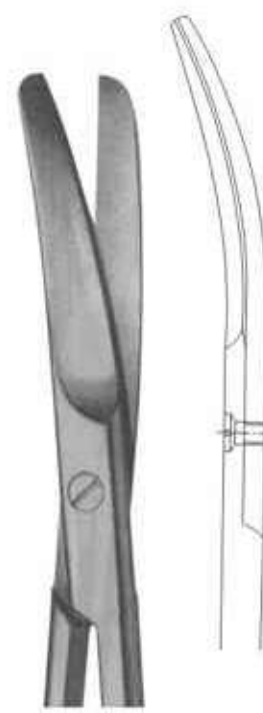

**03-169**  
Size: 145 mm



**03-170 - 172**  
Incision scissors



**03-170**  
Size: 130 mm



**03-171**  
Size: 145 mm



**03-172**  
Size: 165 mm



**03-173**  
SYSTRUNK  
Nail splitting scissors



**03-173**  
Size: 130 mm

# Dissecting Scissors

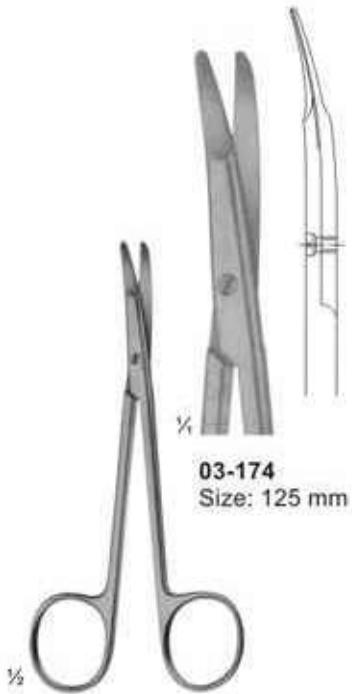

**03-174**  
Size: 125 mm



**03-175**  
Size: 150 mm

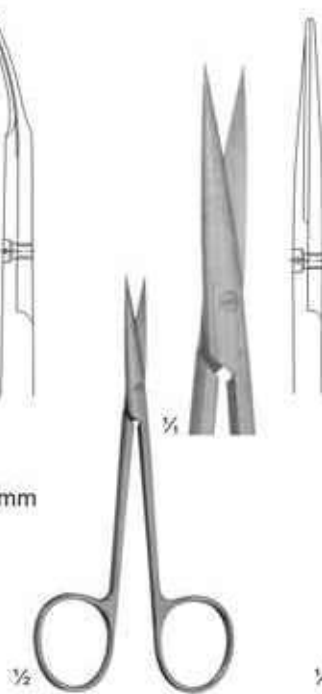

**03-176**  
KILNER  
Fine dissecting scissors  
Size: 115 mm



**03-177**  
JAMESON  
Dissecting scissors  
Size: 150 mm

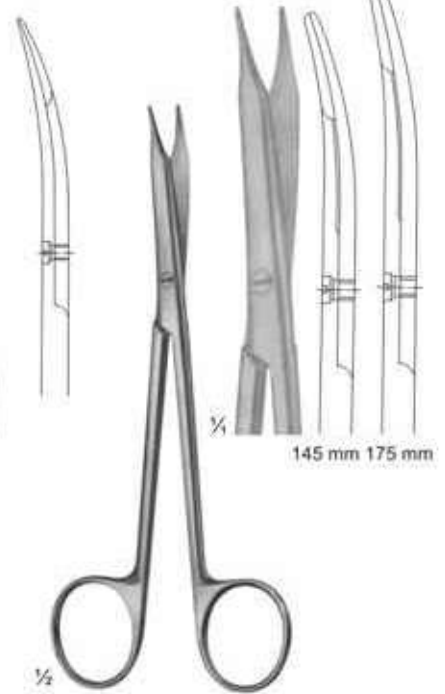

**03-178**  
REYNOLDS  
Dissecting scissors  
Size: 145 - 175 mm

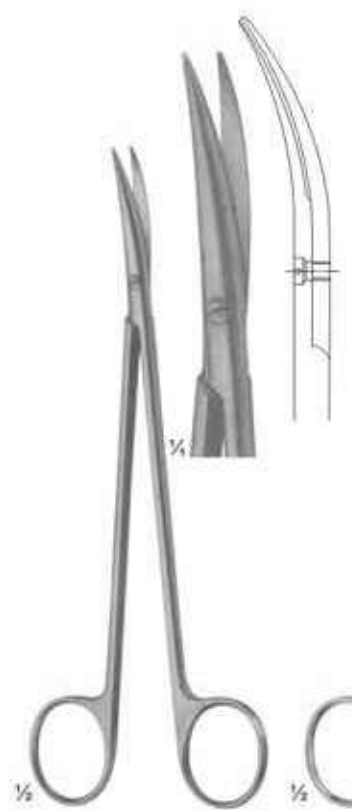

**03-179**  
DE BAKEY  
Arteriotomy scissors  
Size: 175 mm

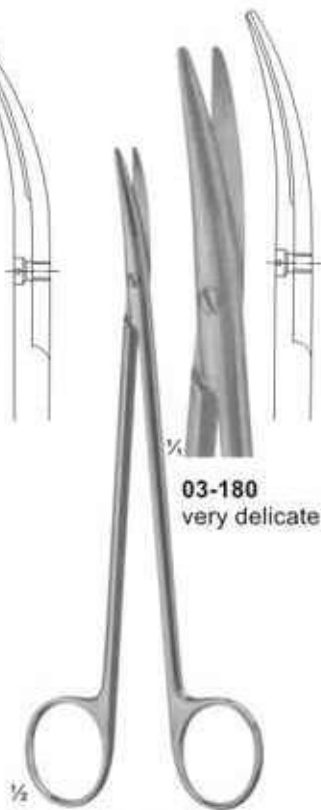

**03-180 - 181**  
TOENNIS ADSON  
Dissecting scissors  
Size: 175 mm

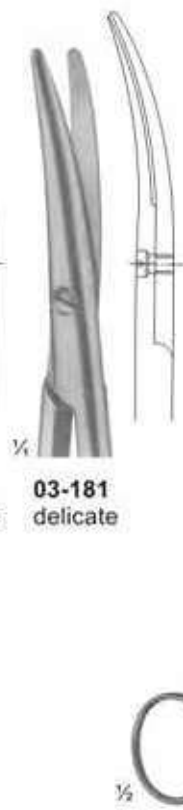

**03-181**  
delicate



**03-182 - 184**  
TOENNIS  
Dissecting scissors  
Size: 180 mm

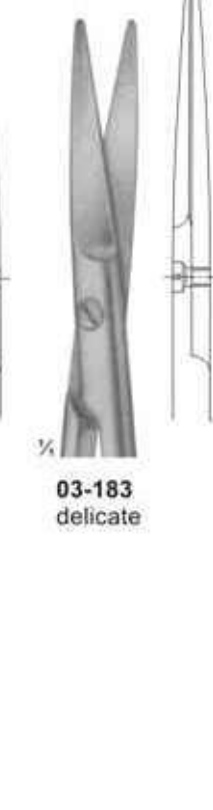

**03-183**  
delicate

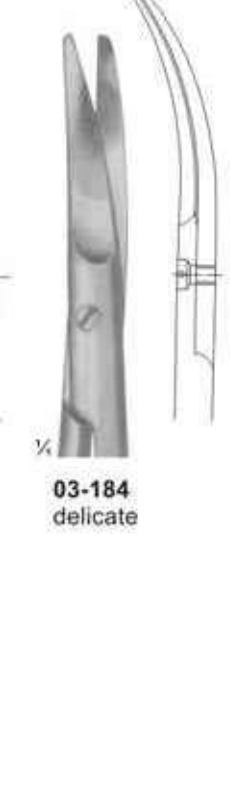

**03-184**  
delicate

# Dissecting Scissors

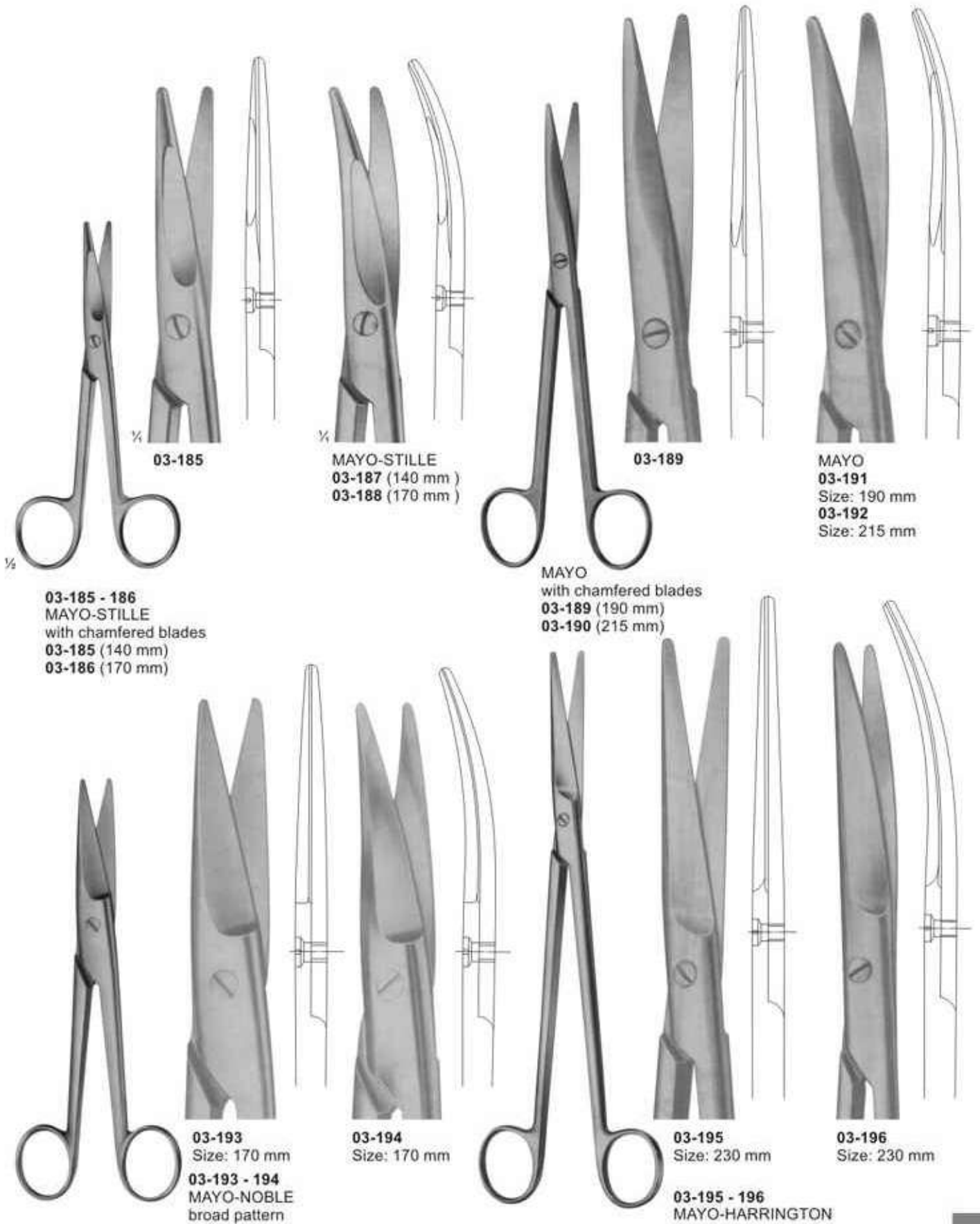

## Scissors for Cardiovascular and Neuro-Surgery



**03-197**  
**OLIVECRONA**  
 Dura scissors



**03-198**  
**STRULLY**  
 pointed  
 Size: 220 mm

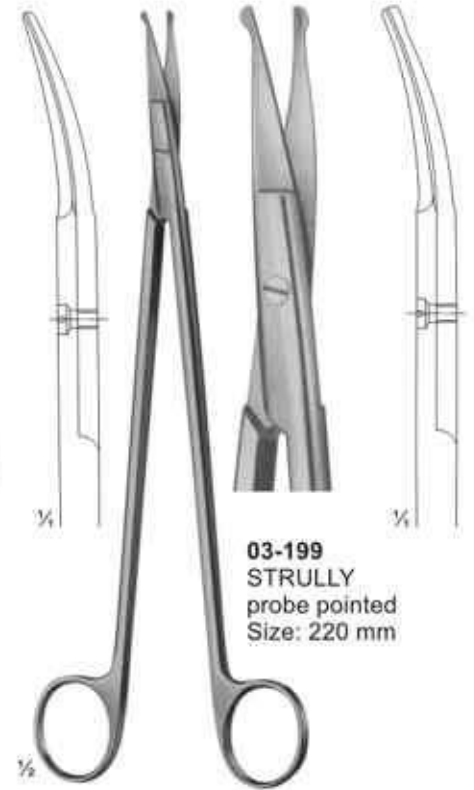

**03-199**  
**STRULLY**  
 probe pointed  
 Size: 220 mm

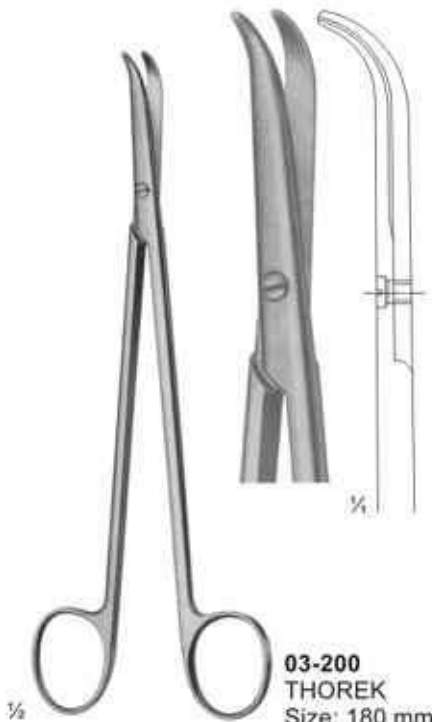

**03-200**  
**THOREK**  
 Size: 180 mm

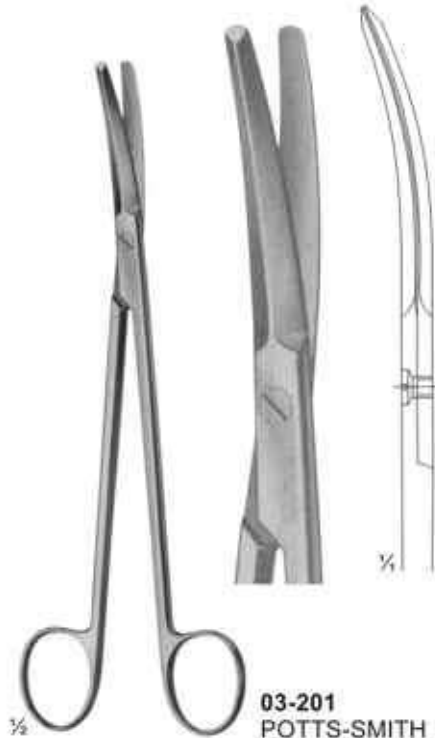

**03-201**  
**POTTS-SMITH**  
 Size: 190 mm

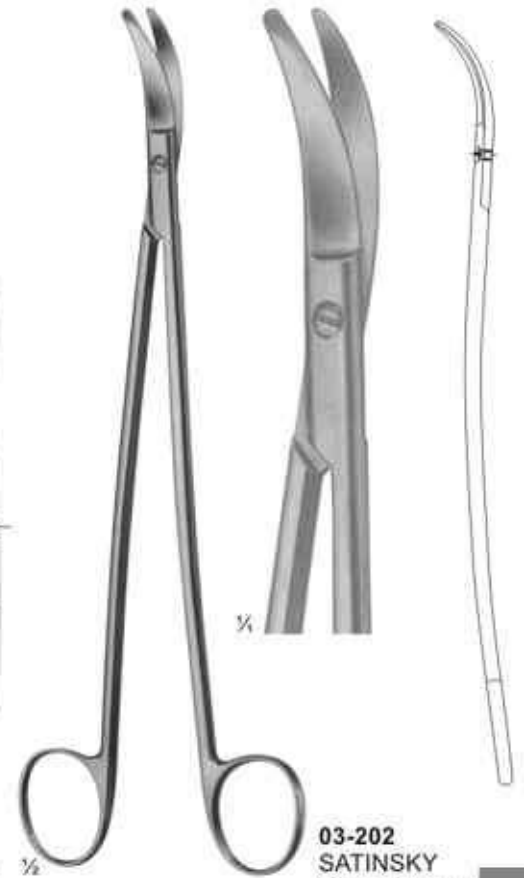

**03-202**  
**SATINSKY**  
 Size: 245 mm

## Delicate, Nasal and Tonsil Scissors

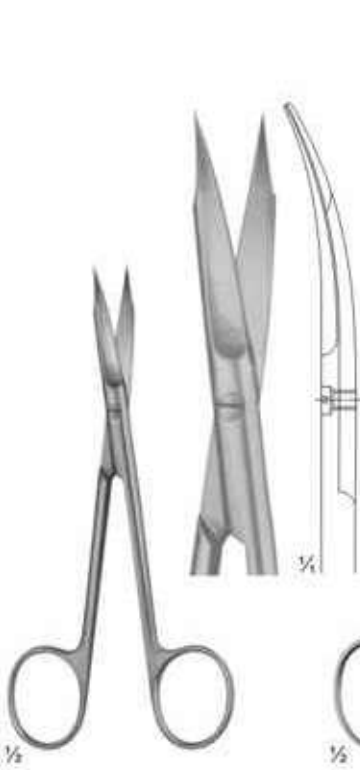

**03-203**  
1 finely toothed blade  
Size: 130 mm

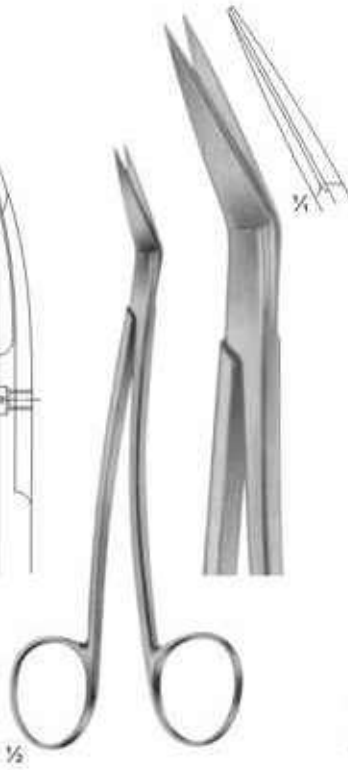

**03-204**  
LOCKLIN  
curved sideways,  
1 toothed blade  
Size: 155 mm



**03-205**  
FOMON  
blades serrated  
Size: 145 mm

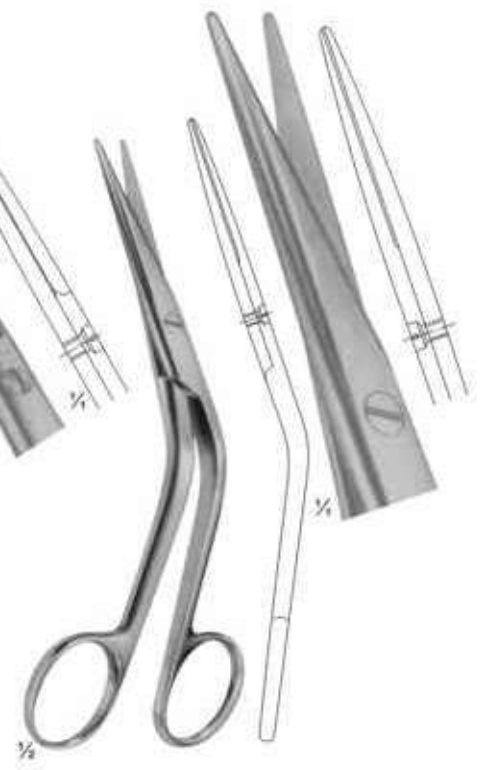

**03-206**  
COTTLE  
Size: 165 mm



**03-207**  
HEYMANN-KNIGHT  
Size: 175 mm

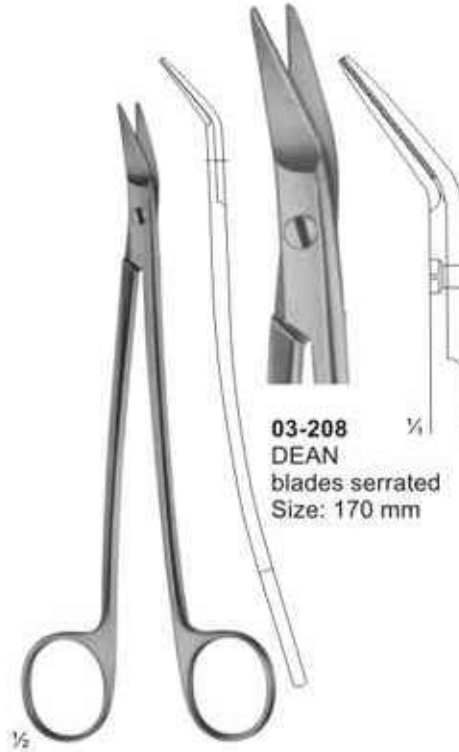

**03-208**  
DEAN  
blades serrated  
Size: 170 mm

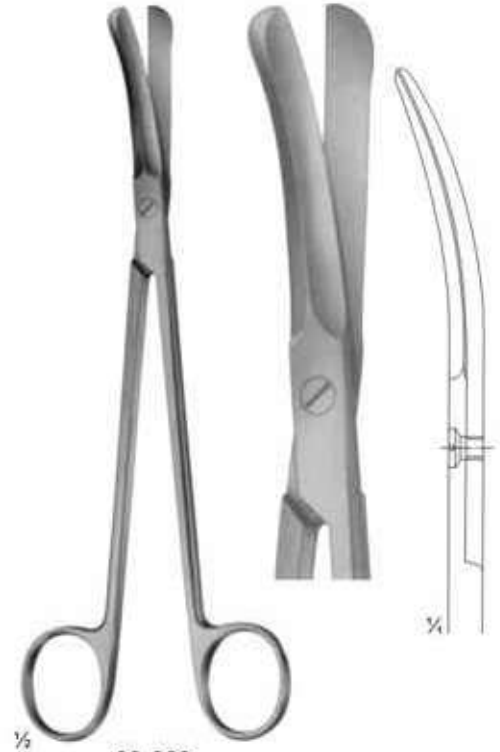

**03-209**  
GOOD  
Size: 195 mm

# Bone Shears

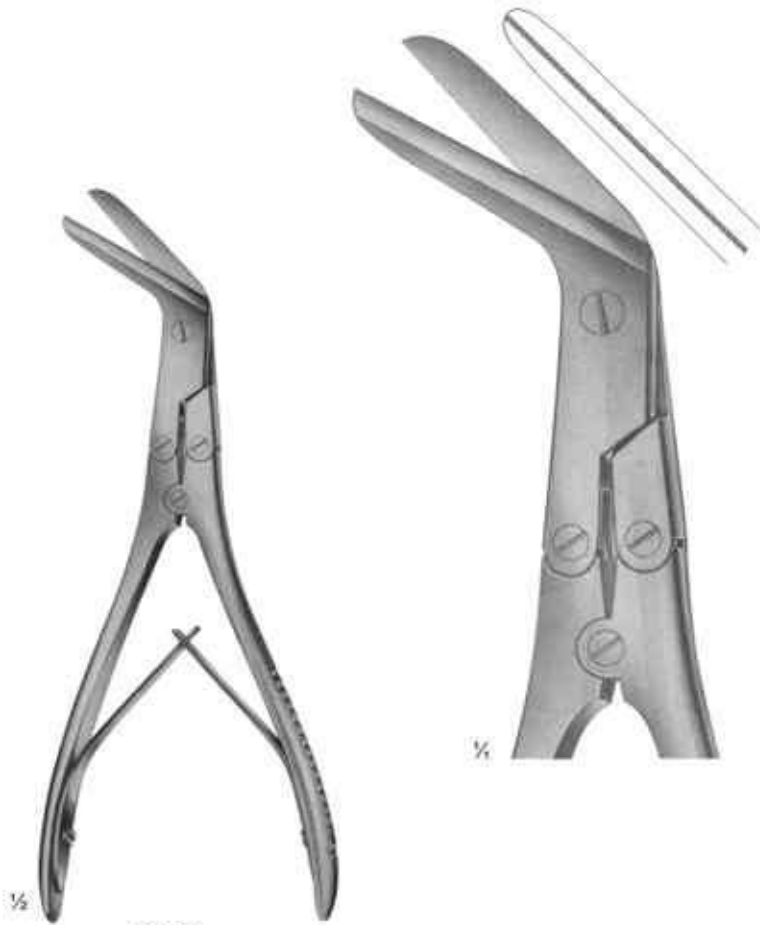

**03-210**  
KILLIAN  
Size: 200 mm



**03-211 - 03-212**



**03-211**  
195 mm



1/2



**03-212**  
225 mm



1/2

# Scissors for deep operations and for Gynaecology

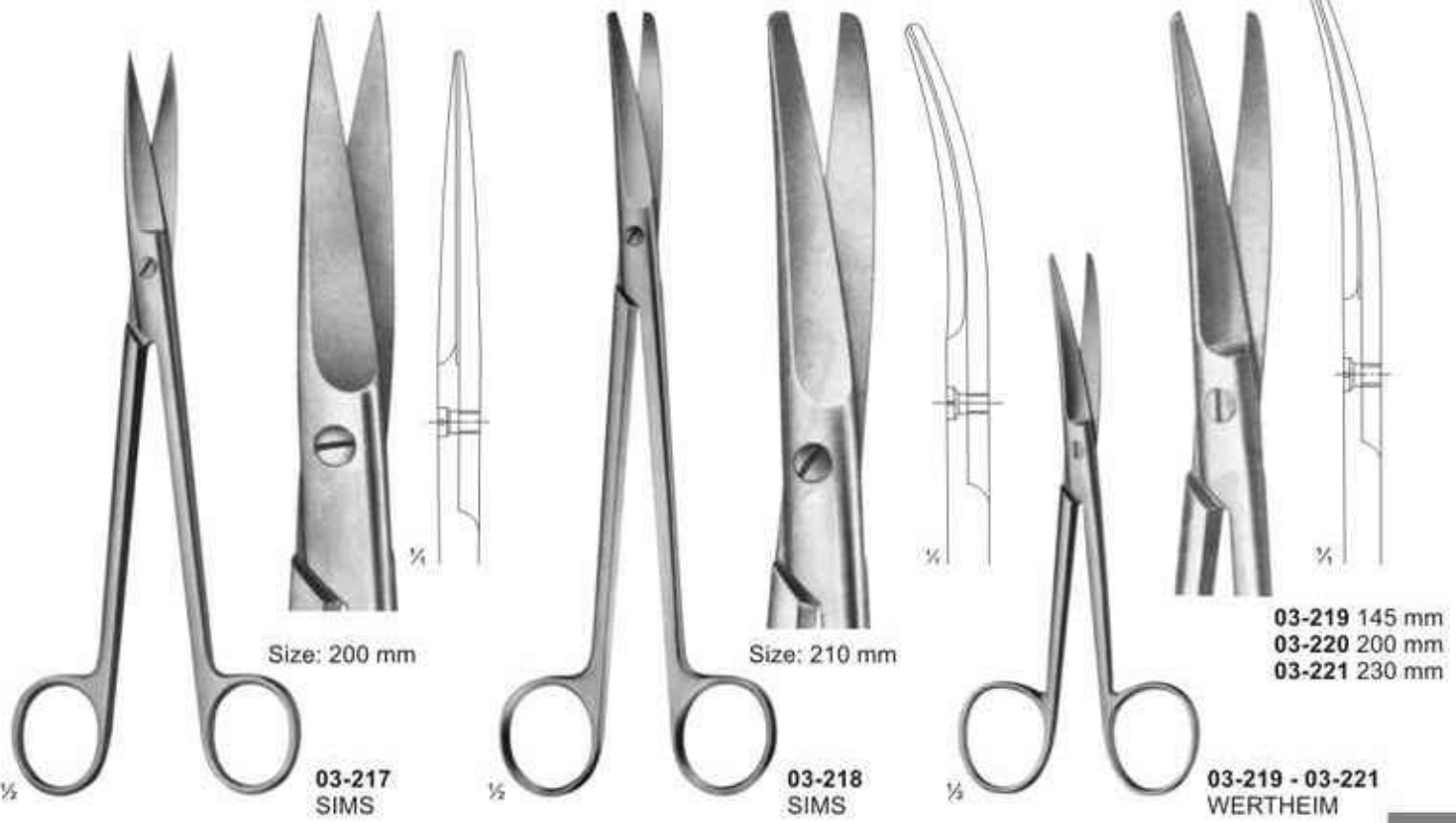
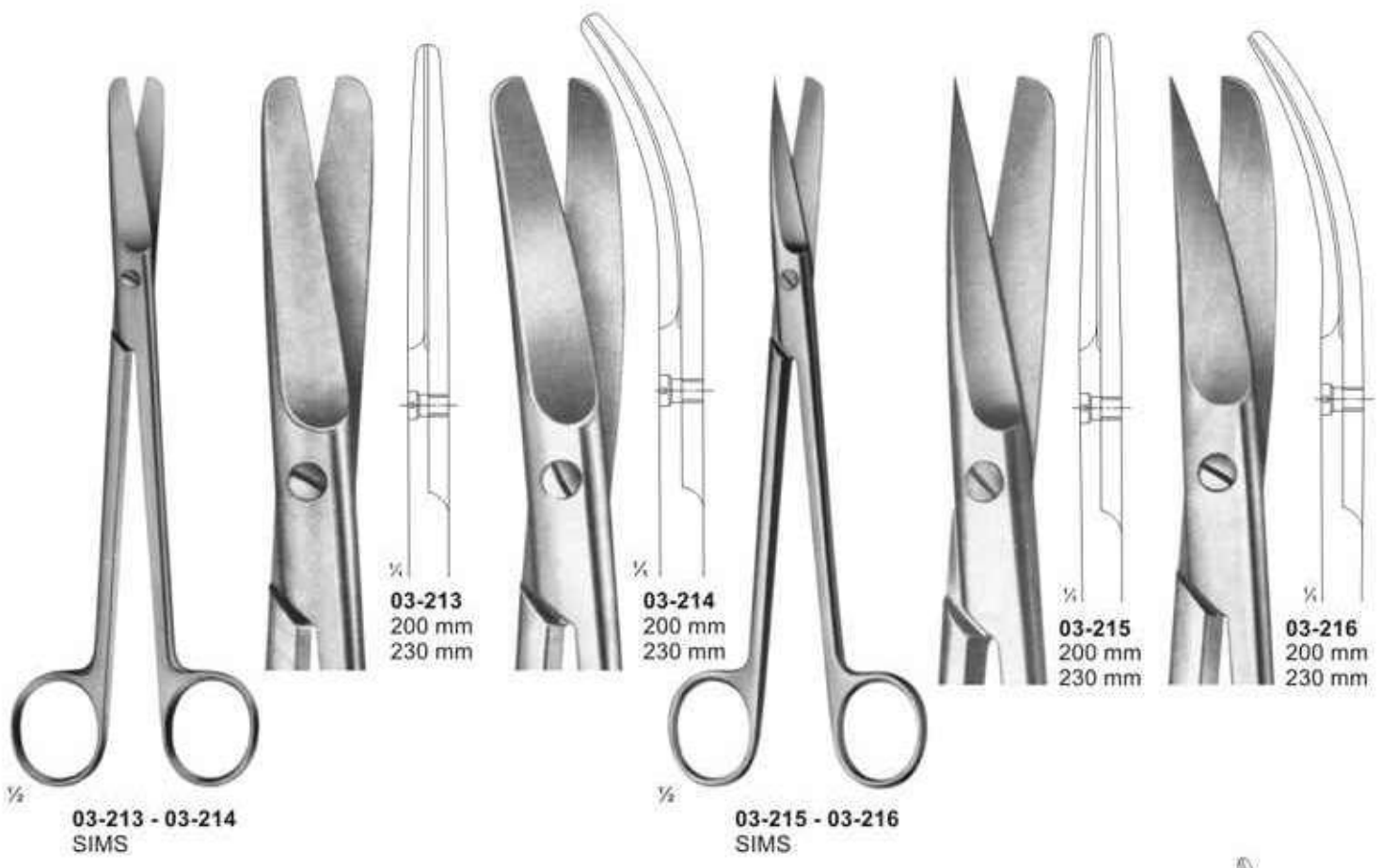

## Scissors for Obstetrics



03-222  
SCHUMACHER  
Umbilical cord scissors  
Size: 155 mm

03-223  
Umbilical cord scissors  
Size: 105 mm

03-224  
Umbilical cord scissors

135 mm

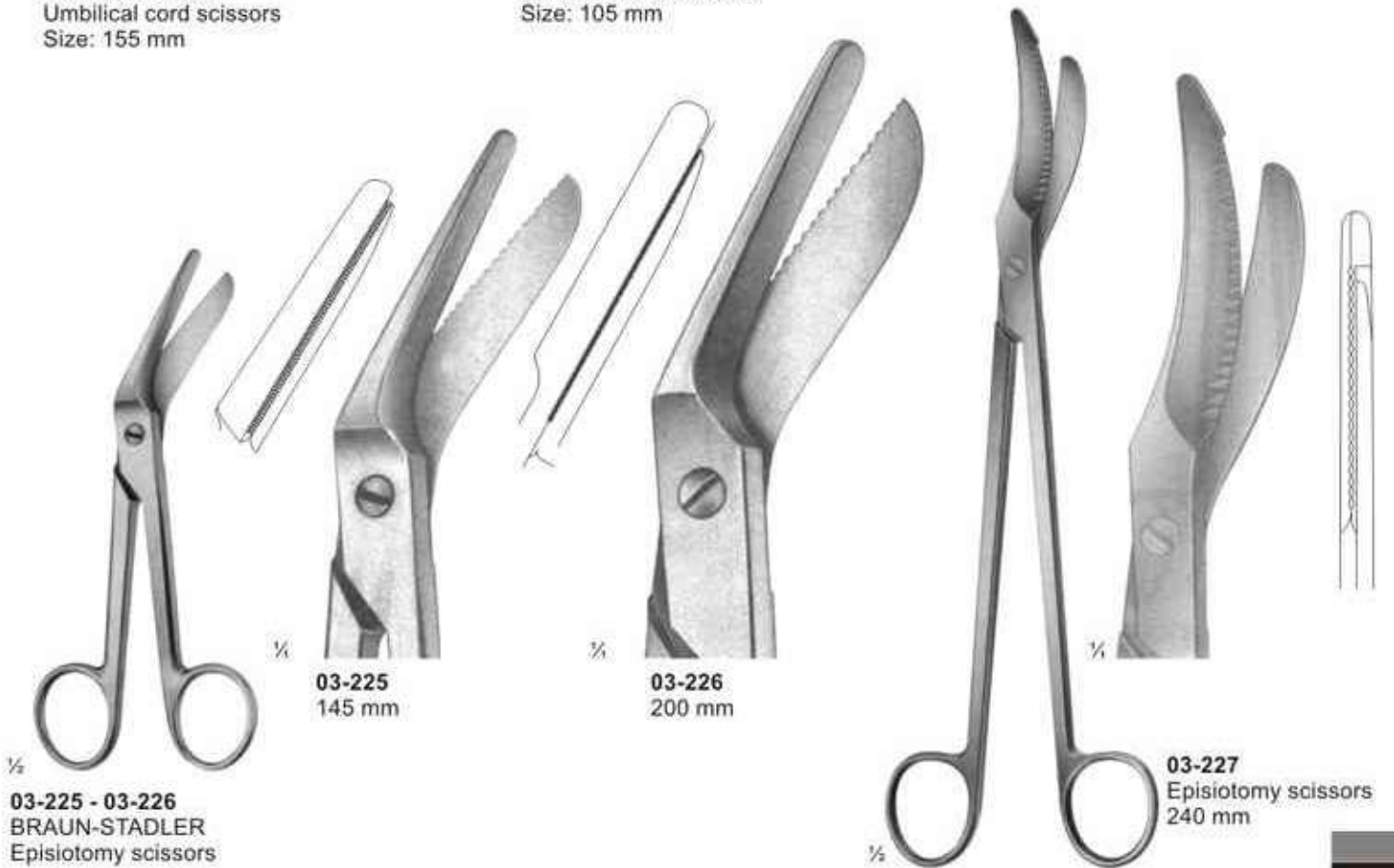

03-225 - 03-226  
BRAUN-STADLER  
Episiotomy scissors

03-225  
145 mm

03-226  
200 mm

03-227  
Episiotomy scissors  
240 mm



## Wire and Plate Scissors

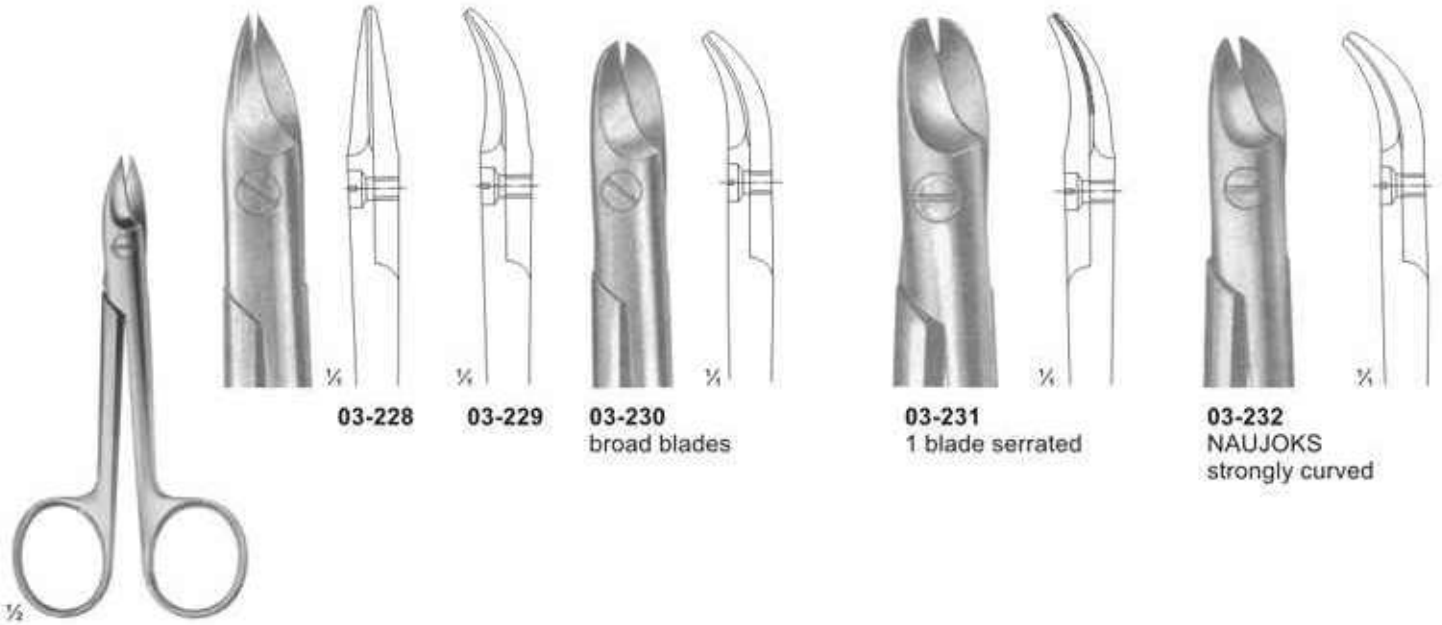

**03-228 - 03-232**  
BEEBE  
Size: 110 mm

03-228

03-229

03-230  
broad blades

03-231  
1 blade serrated

03-232  
NAUJOKS  
strongly curved

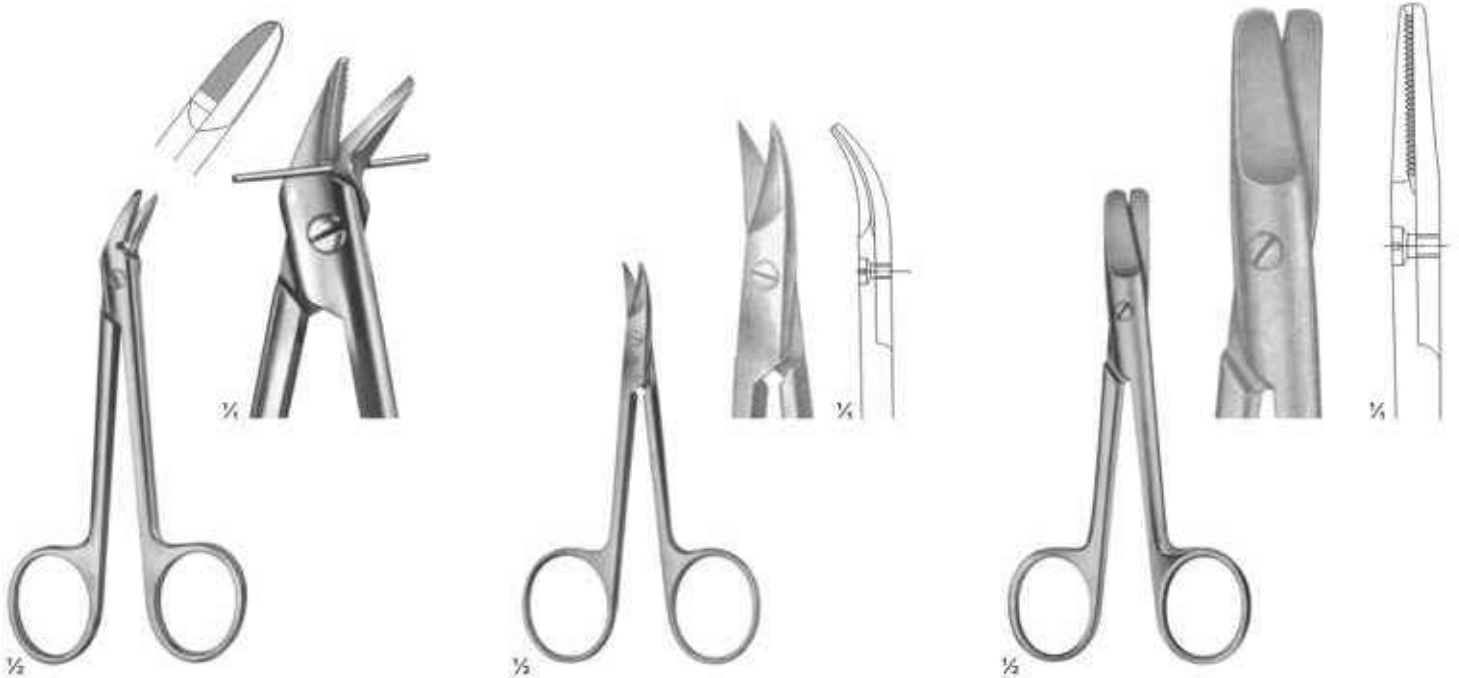

**03-233**  
1 blade serrated  
Size: 120 mm

**03-234**  
STRACK  
Size: 100 mm

**03-235**  
HARVEY  
blades serrated  
Size: 125 mm

## Bandage and Cloth Scissors



**03-236**  
Universal bandage and cloth scissors,  
with toothed edges  
180 mm

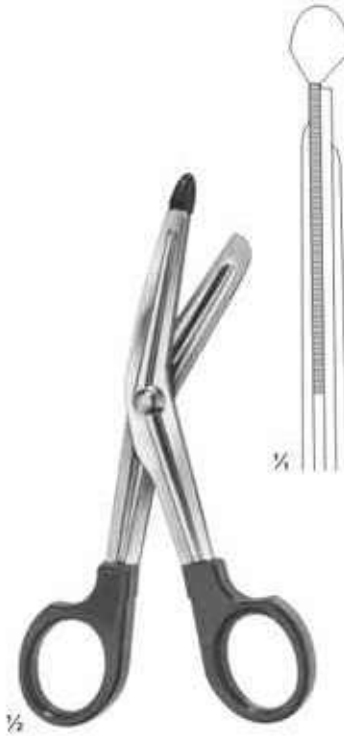

**03-237**  
LISTER  
Universal bandage and cloth scissors,  
with toothed edges  
Size: 145 mm

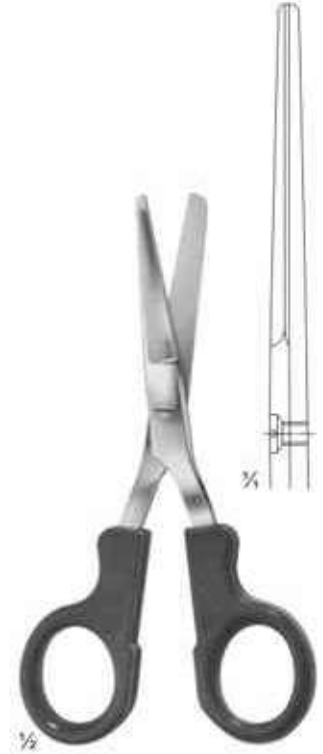

**03-238**  
LISTER  
Nurse's scissors  
Size: 145 mm

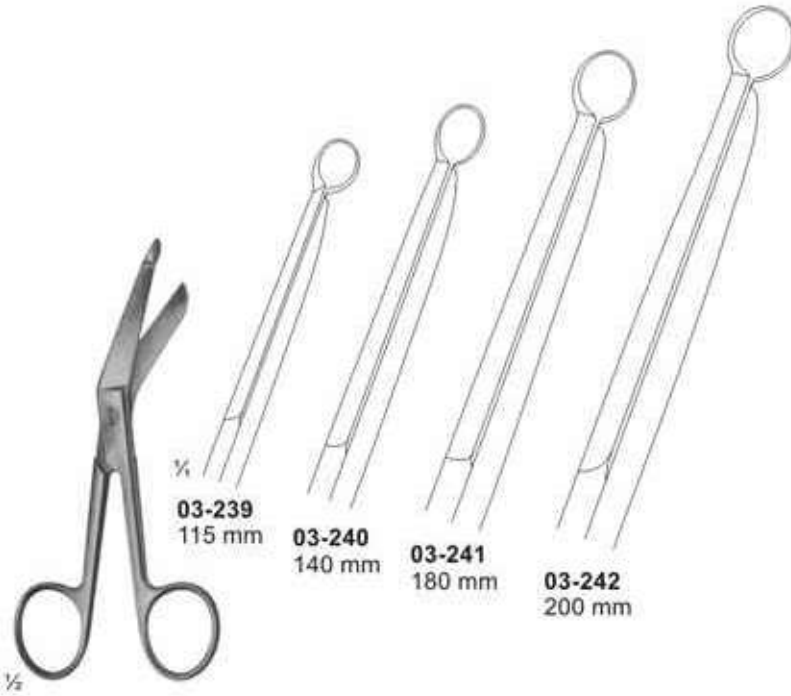

**03-239 - 03-242**  
LISTER

**03-239**  
115 mm

**03-240**  
140 mm

**03-241**  
180 mm

**03-242**  
200 mm

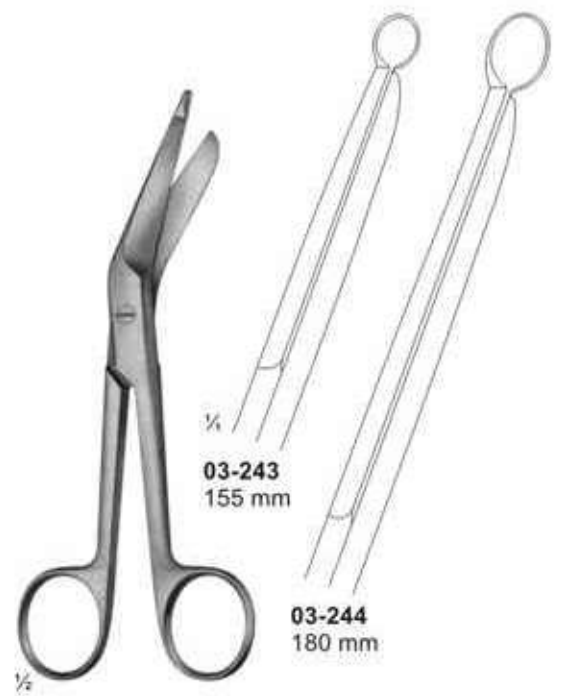

**03-243 - 03-244**  
LISTER

**03-243**  
155 mm

**03-244**  
180 mm

## Bandage-, Cloth-, and Plaster Scissors



**03-245**  
CLOTH SCISSORS  
205 mm

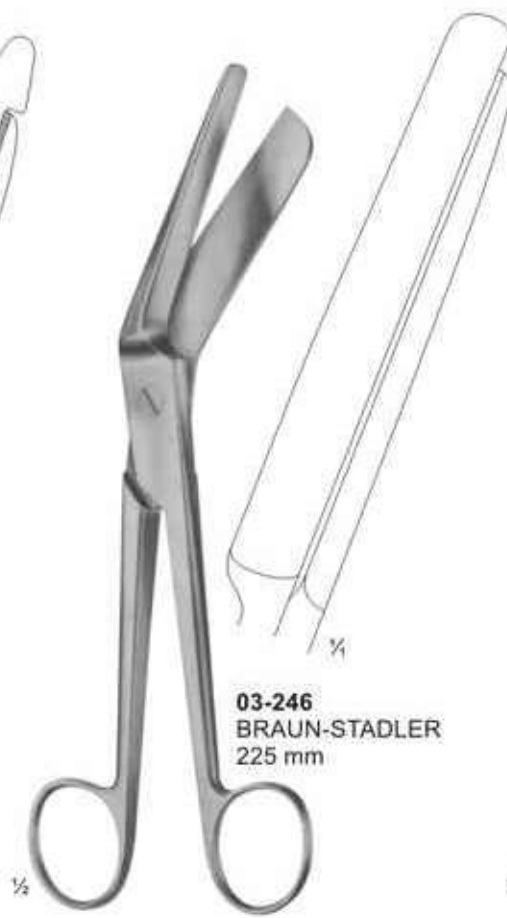

**03-246**  
BRAUN-STADLER  
225 mm



**03-247**  
SEUTIN  
230 mm



**03-248** **03-249**  
200 mm 230 mm

**03-248 - 03-249**  
ESMARCH



**03-250**  
BRUNS  
235 mm

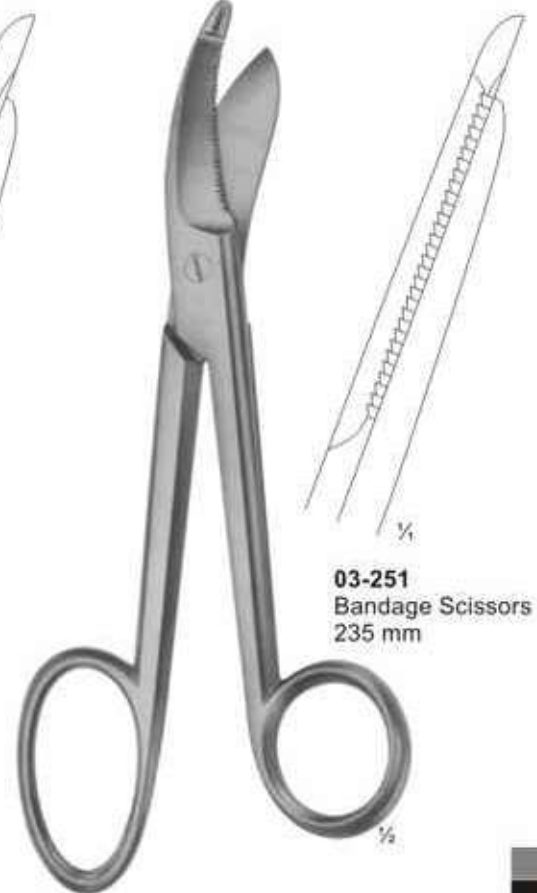

**03-251**  
Bandage Scissors  
235 mm

## Forceps for grasping tissue, tumors etc.

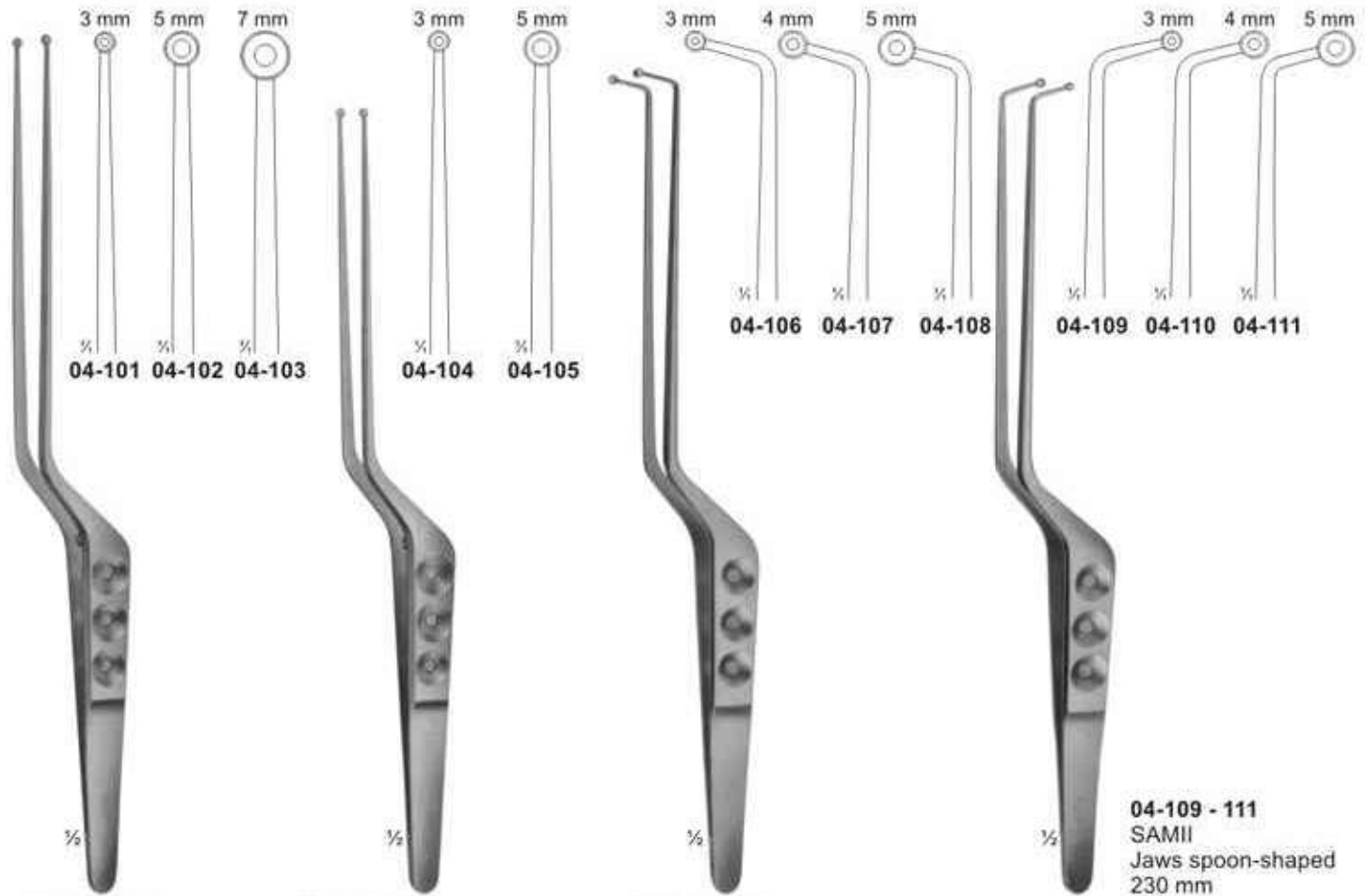

**04-101 - 103**  
YASARGIL-SAMII  
Jaws spoon-shaped  
240 mm

**04-104 - 105**  
YASARGIL  
Jaws spoon-shaped  
220 mm

**04-106 - 108**  
SAMII  
Jaws spoon-shaped  
230 mm

**04-109 - 111**  
SAMII  
Jaws spoon-shaped  
230 mm



**04-112**  
HUNT  
Tumor-and  
vessel forceps  
200 mm



**04-113**  
HUNT  
Tumor-and  
vessel forceps  
200 mm



**04-114**  
YASARGIL  
Tumor-and  
vessel forceps  
200 mm

# Delicate Dissecting, Microscopic, Sterilizing Forceps



**04-115**  
**THORPE**  
 Corneal forceps  
 120 mm



**04-116**  
**MICRO-ADSON**  
 120 mm



**04-117**  
**ADSON**  
 120 mm



**04-118**  
**MICRO-ADSON**  
 150 mm



**04-119 - 121**  
 100 mm



**04-119**



**04-120**



**04-121**

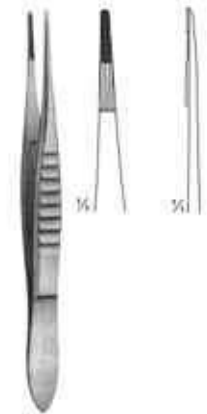

**04-122**  
**BONACCOLTO**  
 110 mm



**04-123**  
 115 mm



**04-124 - 133**

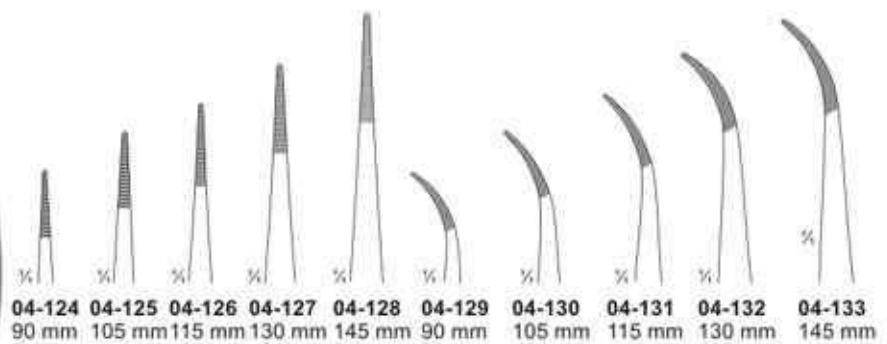

**04-124** 90 mm  
 **04-125** 105 mm  
 **04-126** 115 mm  
 **04-127** 130 mm  
 **04-128** 145 mm  
 **04-129** 90 mm  
 **04-130** 105 mm  
 **04-131** 115 mm  
 **04-132** 130 mm  
 **04-133** 145 mm



**04-134**  
 100 mm



**04-135**  
 100 mm



**04-136**  
 100 mm

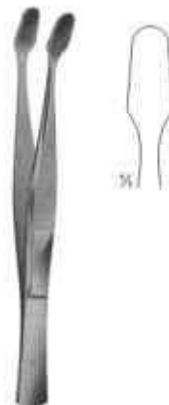

**04-137**  
**KUHNE**  
 Cover glass forceps, 105 mm



**04-138**  
 160 mm

# Delicate Dissecting Forceps

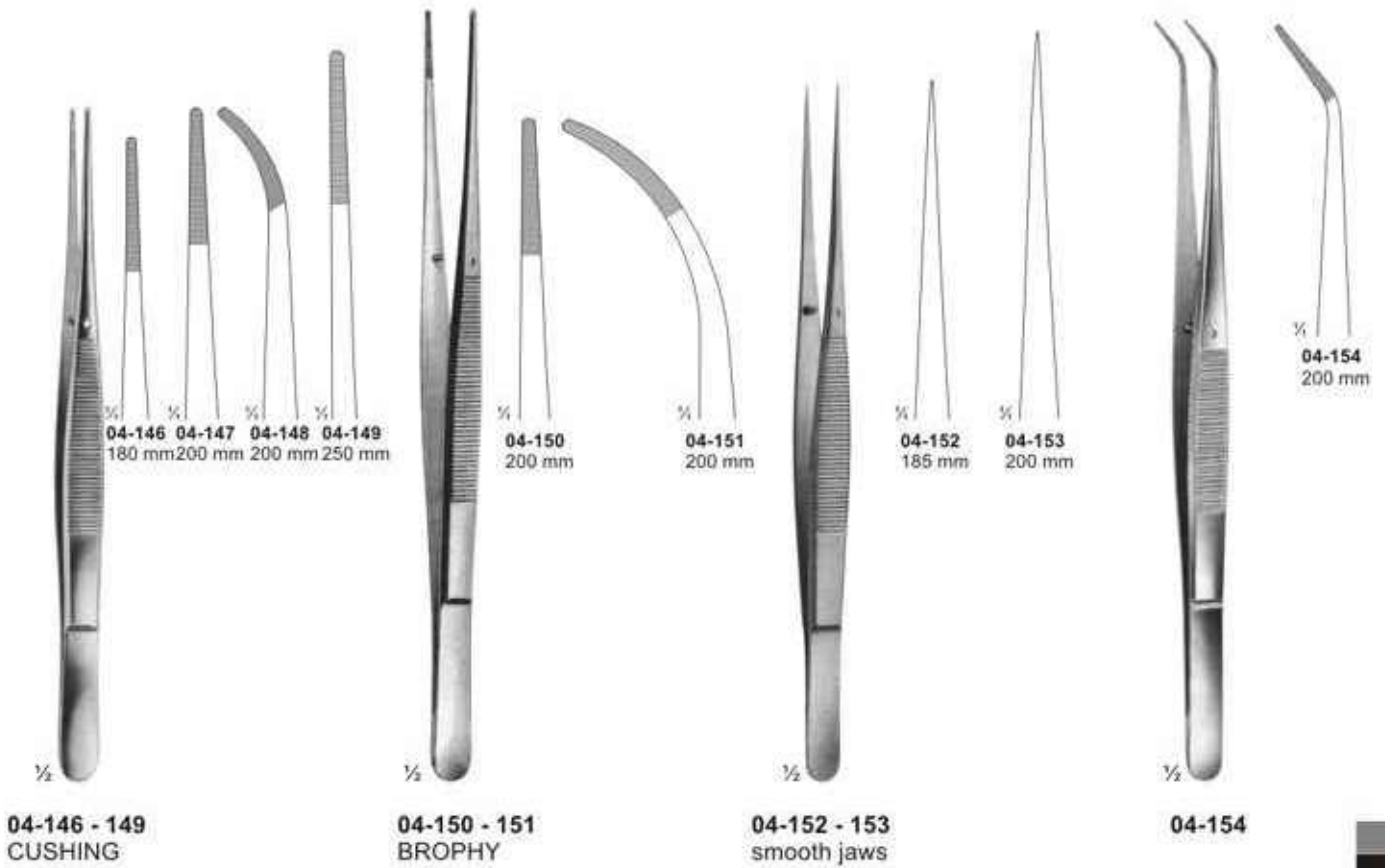
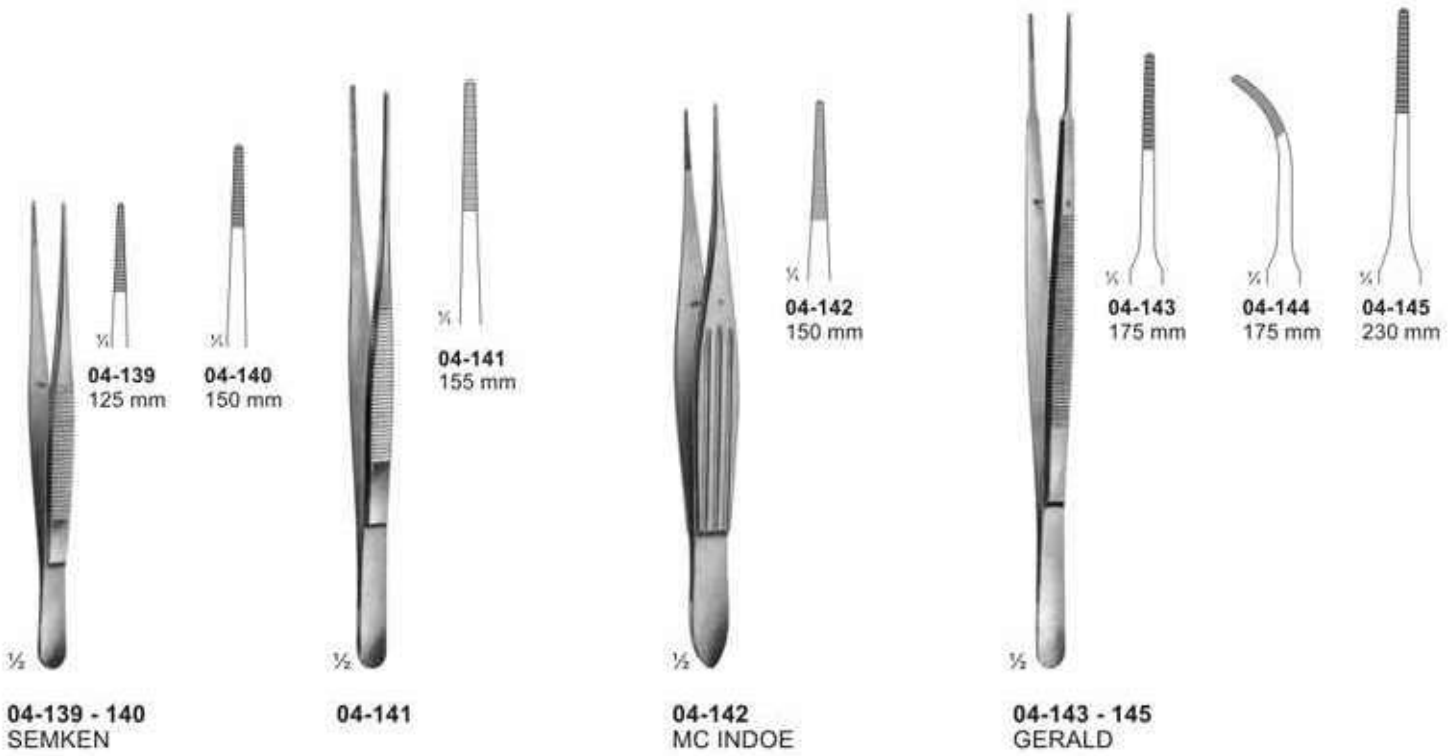

# Dissecting Forceps

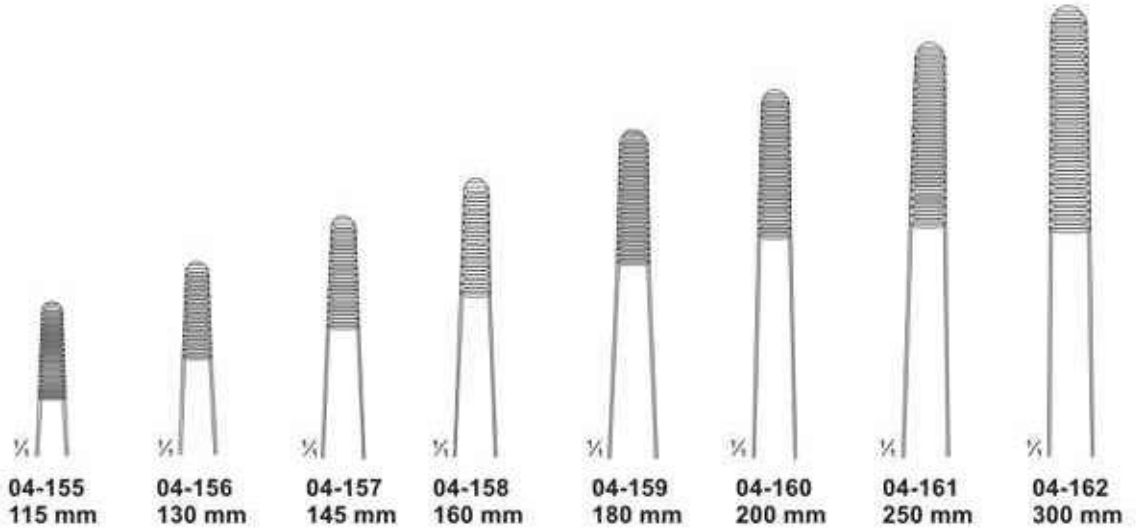

04-155 115 mm    04-156 130 mm    04-157 145 mm    04-158 160 mm    04-159 180 mm    04-160 200 mm    04-161 250 mm    04-162 300 mm

04-155 - 04-162  
STANDARD



04-163 115 mm    04-164 130 mm    04-165 145 mm    04-166 160 mm    04-167 305 mm

04-168 130 mm    04-169 145 mm

04-163 - 04-167  
MEDIUM

04-168 - 04-169  
MEDIUM

# Forceps

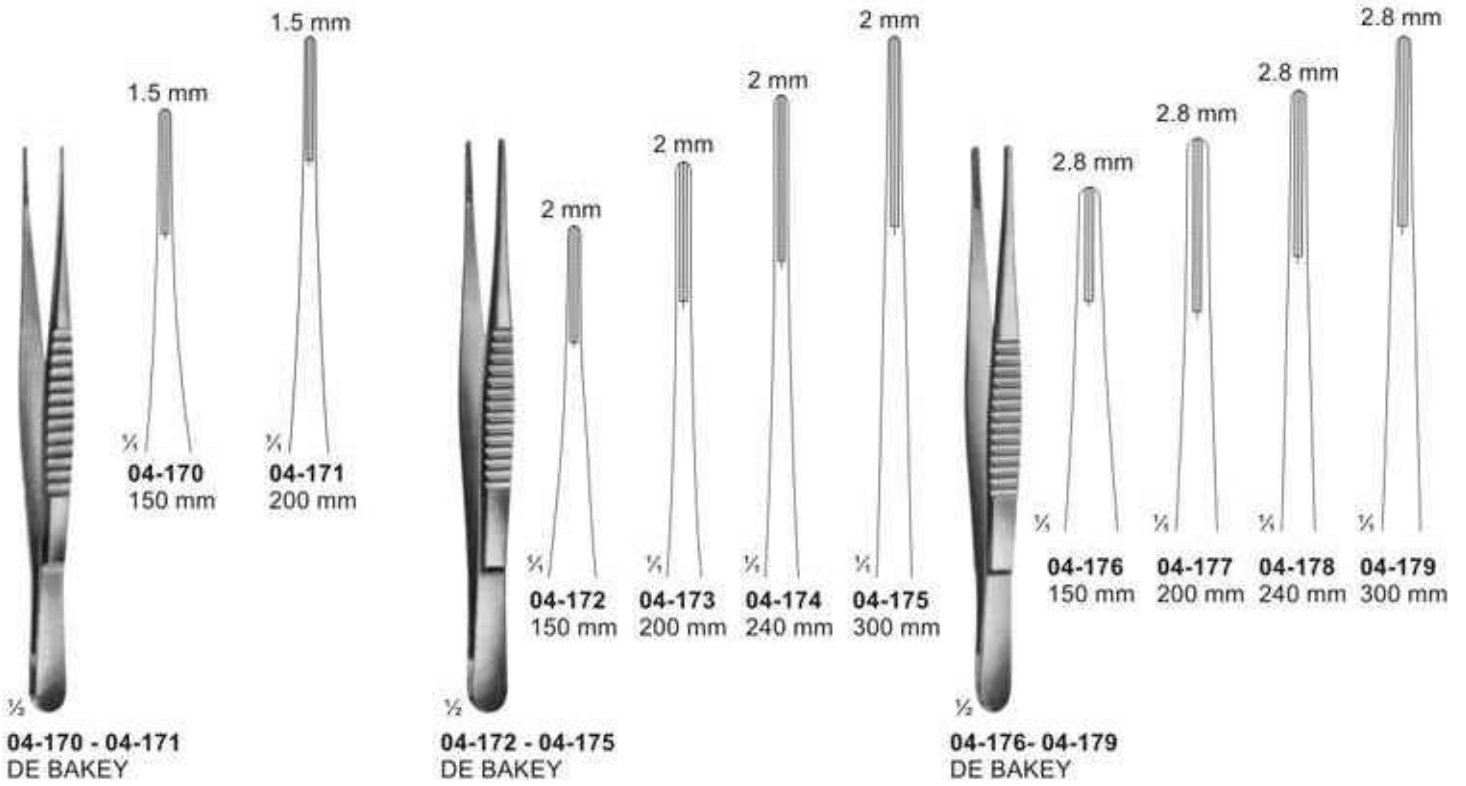



## Delicate Tissue Forceps



04-185  
BISHOP-HARMON  
85 mm

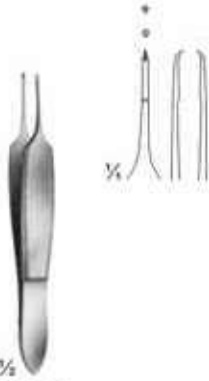

04-186  
ST.MARTIN  
80 mm

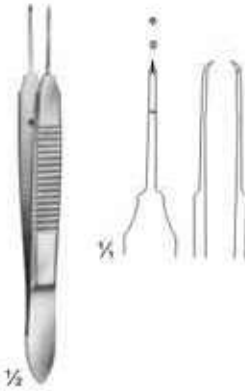

04-187  
CASTROVIEJO  
teeth 0.9 mm  
100 mm

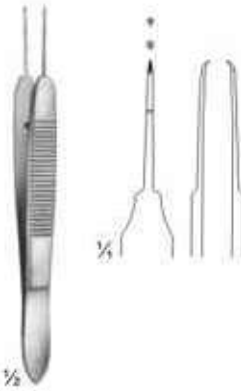

04-188  
CASTROVIEJO  
teeth 0.5 mm  
100 mm

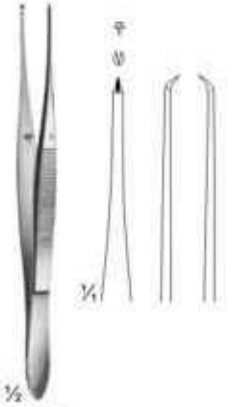

04-189  
ELSCHING  
110 mm



04-190  
GILL  
75 mm



04-191  
GILL - HESS  
75 mm

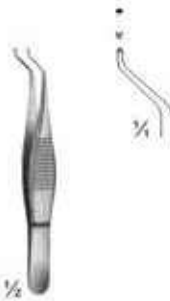

04-192  
HESS  
70 mm



04-193  
ARRUGA  
100 mm

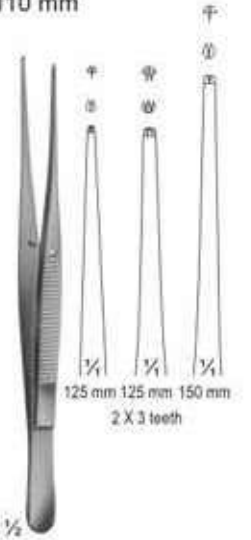

04-194  
SEMKEN  
125 mm 125 mm 150 mm  
2 X 3 teeth



04-195  
MICRO-ADSON  
120 mm



04-196  
ADSON  
120 mm



04-197  
ADSON  
120 mm



04-198  
ADSON  
120 mm



04-199  
ADSON  
150 mm

# Tissue Forceps

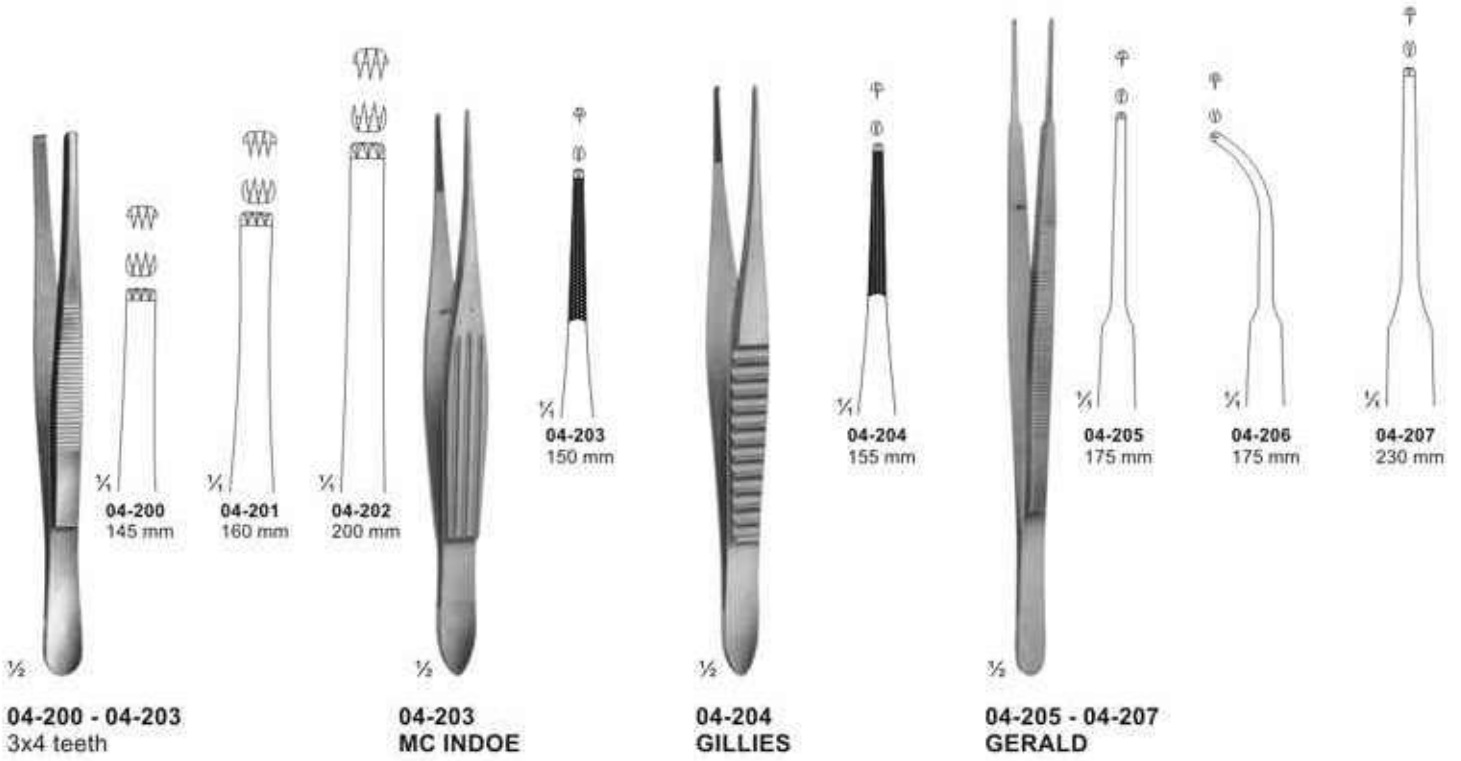

# Tissue Forceps



**04-213**  
**ADSON - BROWN**  
Non-traumatic  
120 mm

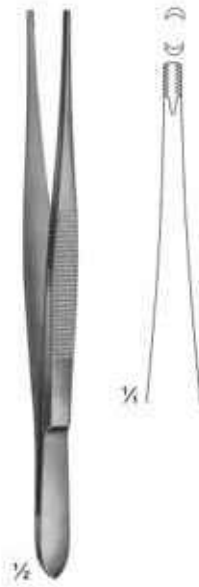

**04-214**  
**BROWN**  
120 mm



**04-215**  
**GRAEFE**  
110 mm



**04-216**  
**GRAEFE**  
With Catch  
110 mm

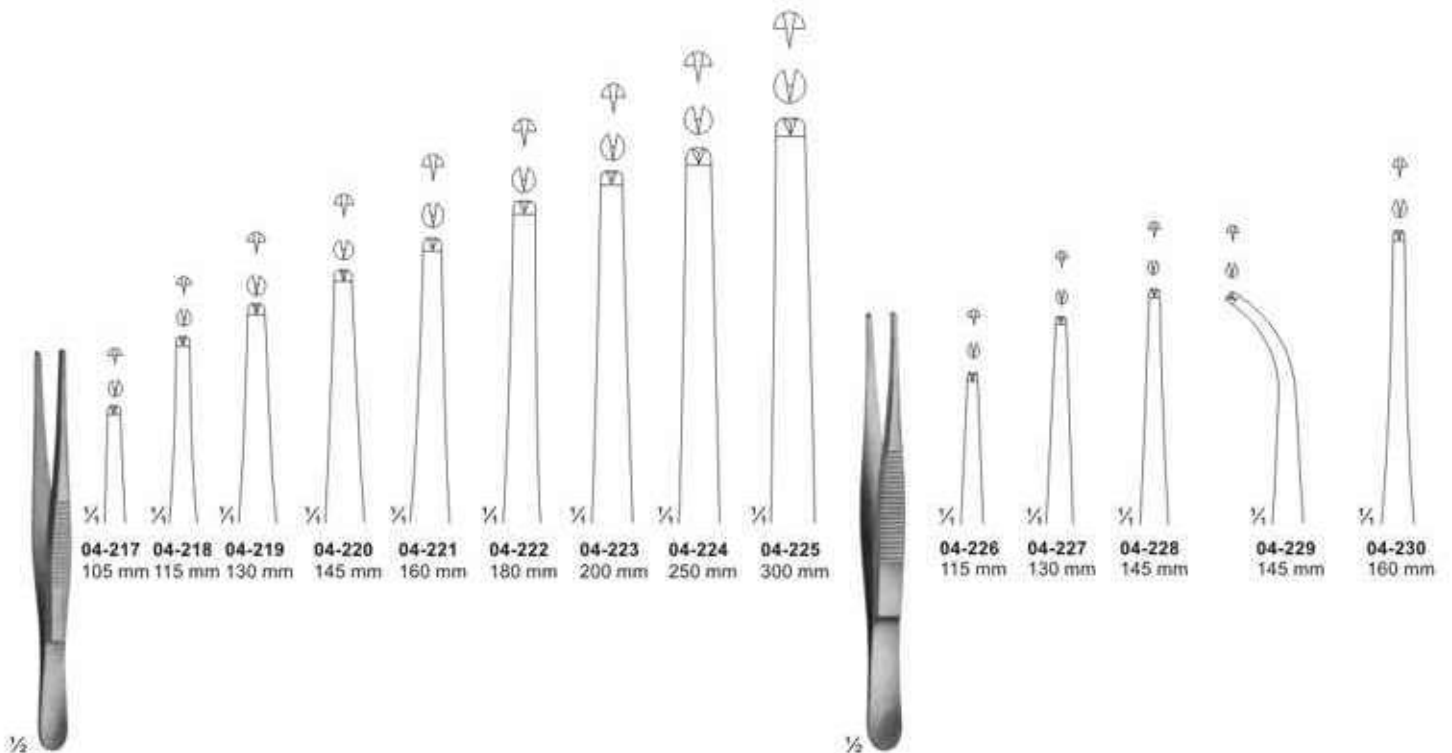

**04-217 - 04-225**  
**STANDARD**

**04-226 - 04-230**  
**GRAEFE**  
110 mm

## Forceps, Bayonet - Shaped

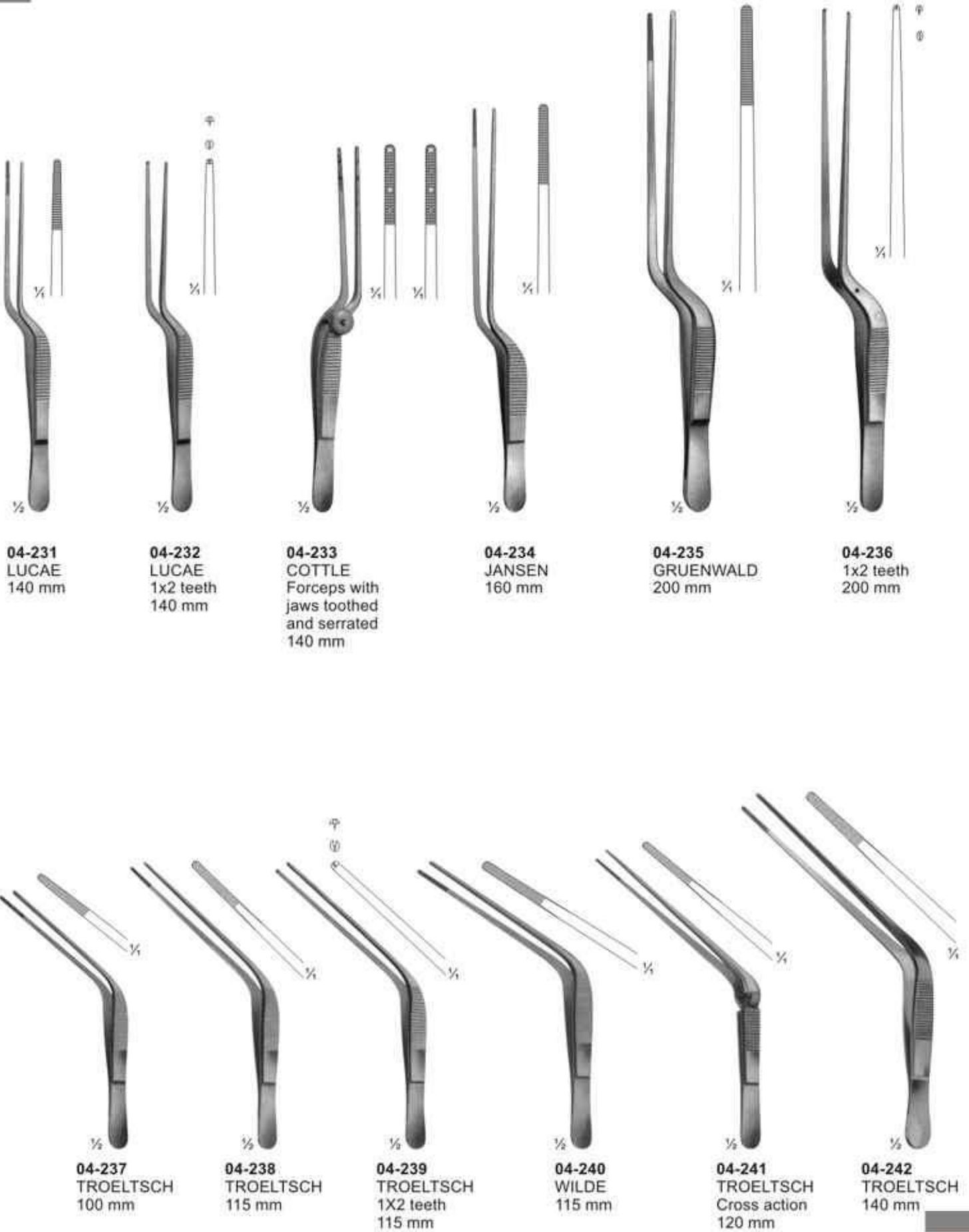

**04-231**  
LUCAE  
140 mm

**04-232**  
LUCAE  
1x2 teeth  
140 mm

**04-233**  
COTTLE  
Forceps with  
jaws toothed  
and serrated  
140 mm

**04-234**  
JANSEN  
160 mm

**04-235**  
GRUENWALD  
200 mm

**04-236**  
1x2 teeth  
200 mm

**04-237**  
TROELTSCH  
100 mm

**04-238**  
TROELTSCH  
115 mm

**04-239**  
TROELTSCH  
1X2 teeth  
115 mm

**04-240**  
WILDE  
115 mm

**04-241**  
TROELTSCH  
Cross action  
120 mm

**04-242**  
TROELTSCH  
140 mm

# Tissue Forceps, Lung Dissecting Forceps

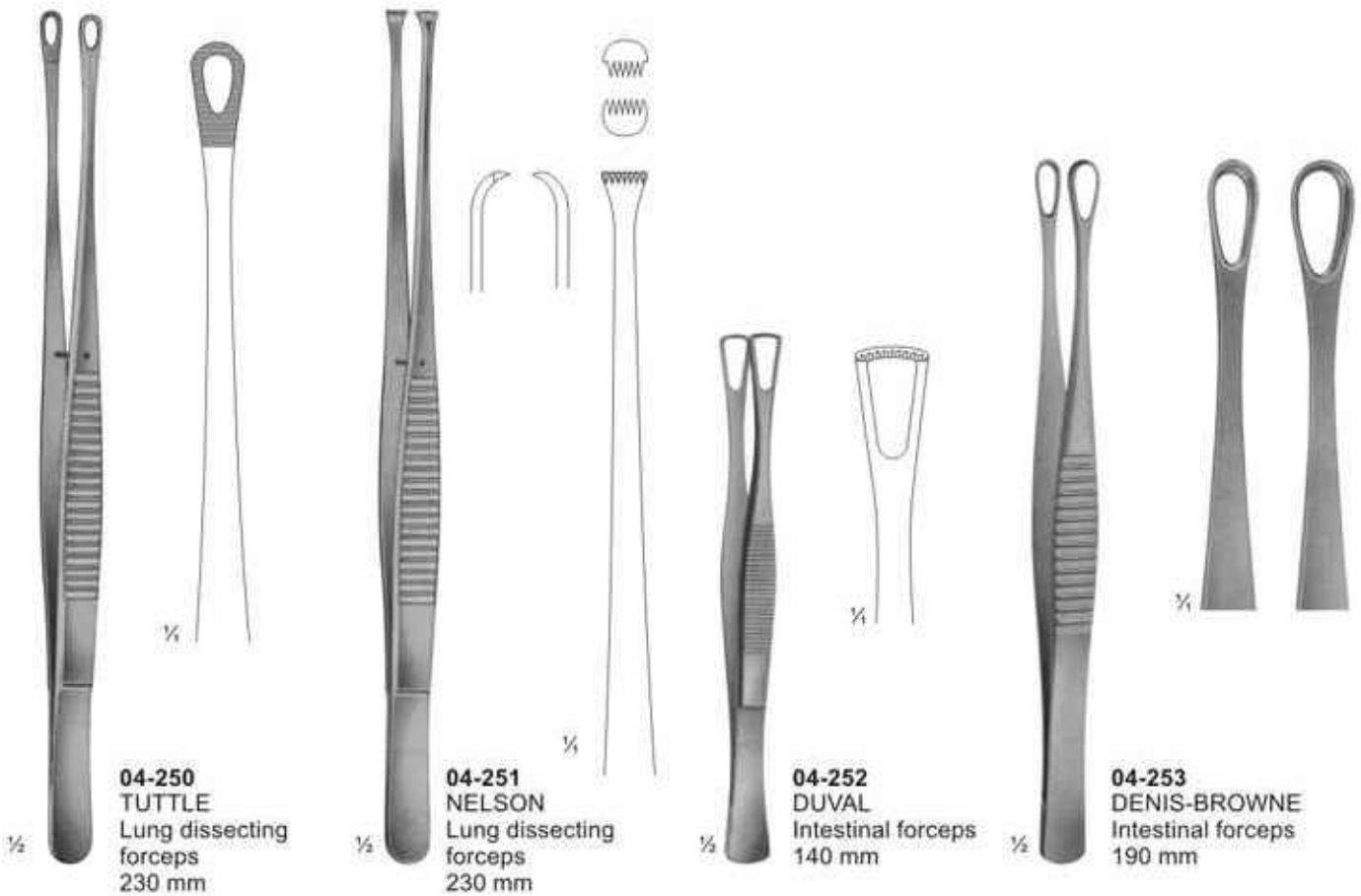
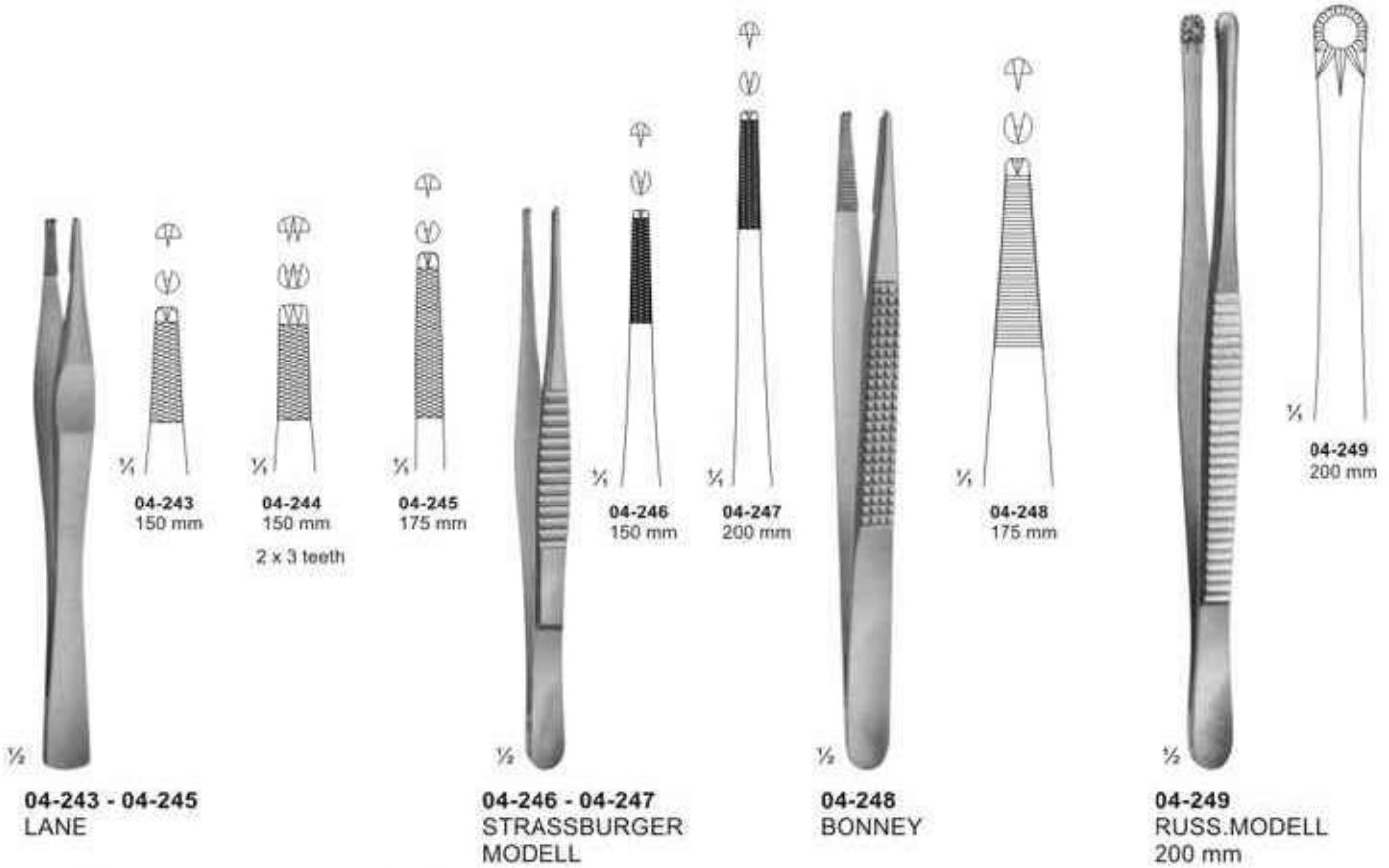

## Splinter and Cilia Forceps

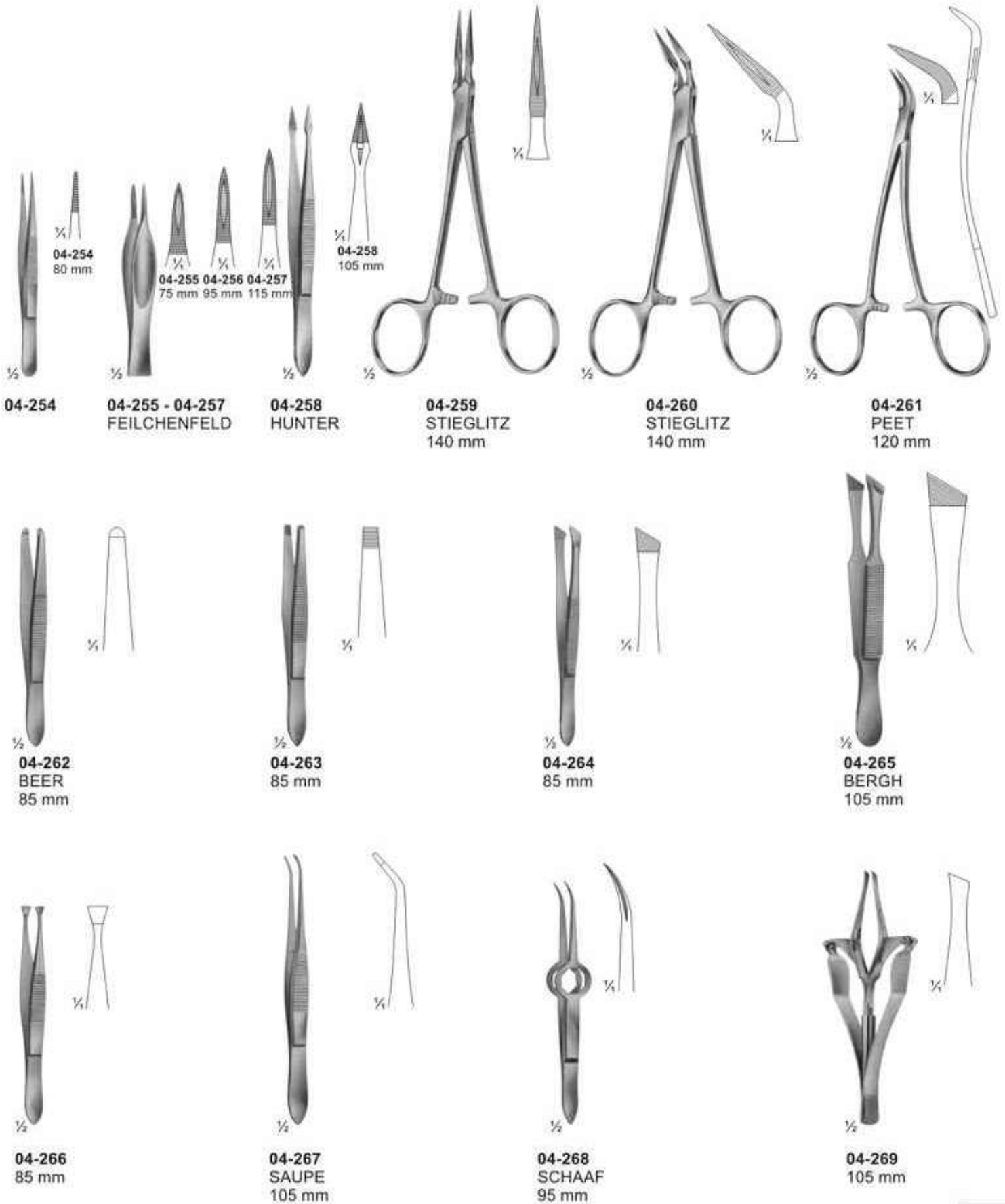

## Sponge and Dressing Forceps

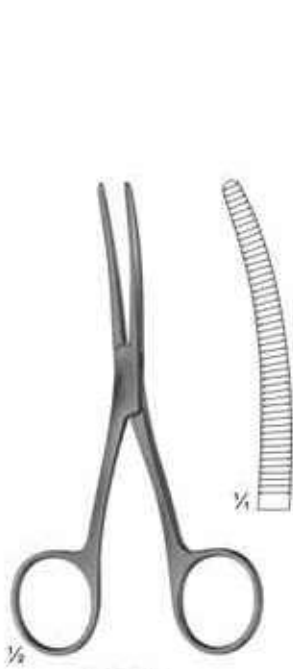

**04-270**  
BRYANT  
130 mm

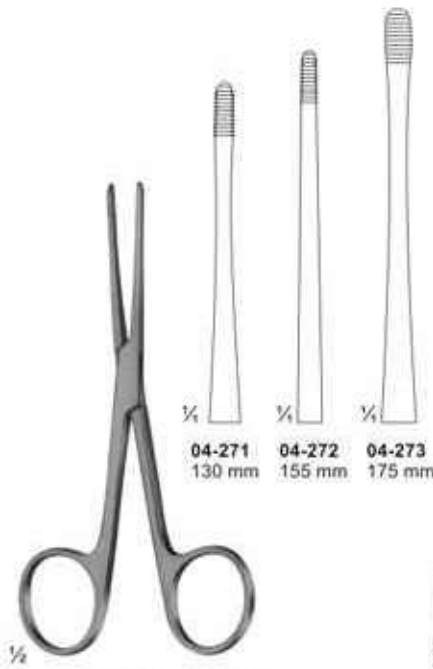

**04-271 - 04-273**  
LISTER  
Sinus forceps

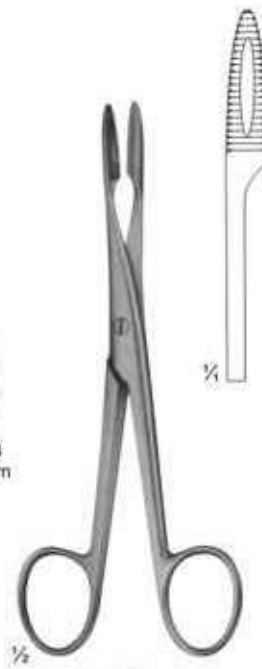

**04-274**  
without ratchet  
145 mm

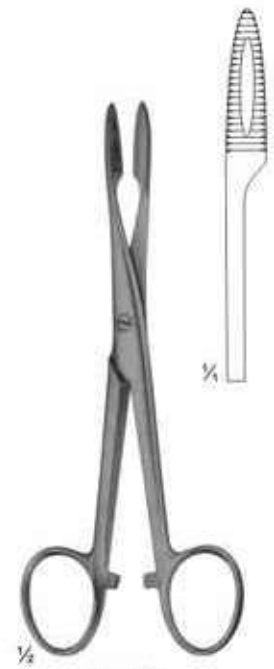

**04-275**  
with ratchet  
145 mm

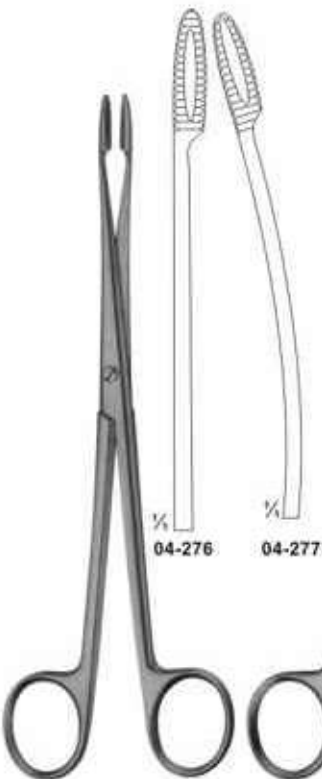

**04-276 - 04-277**  
GROSS  
without ratchet  
180 mm

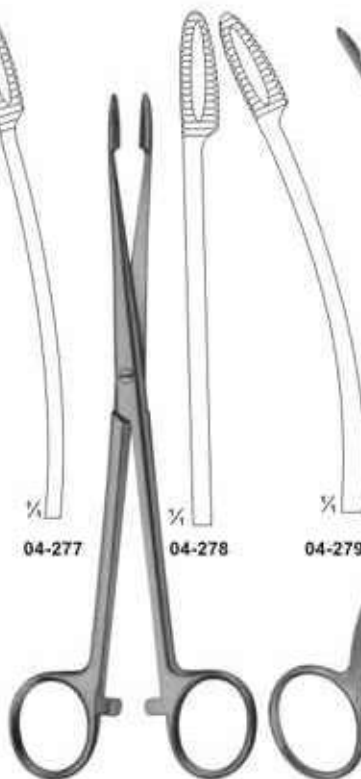

**04-278 - 04-279**  
GROSS  
with ratchet  
180 mm

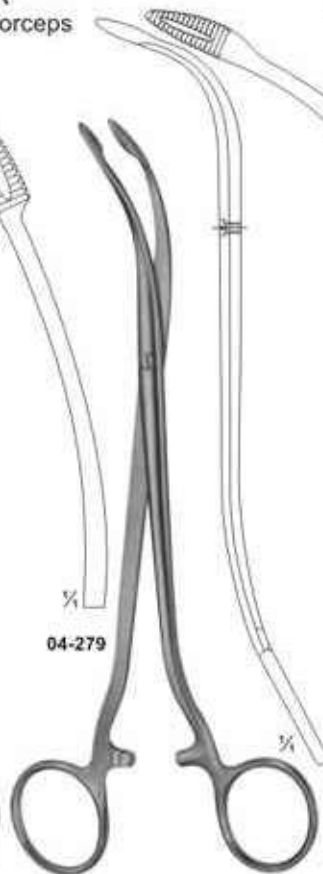

**04-280**  
DUPLAY  
190 mm

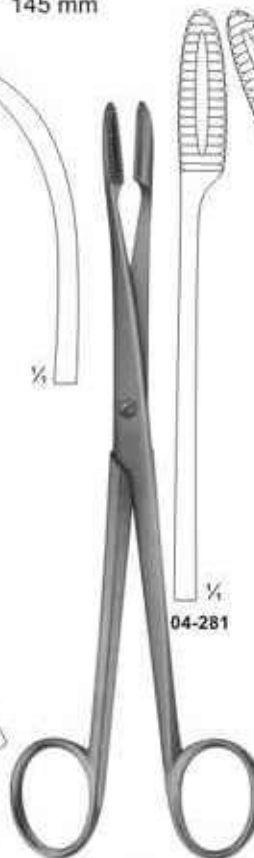

**04-281 - 04-282**  
GROSS  
without ratchet  
200 mm

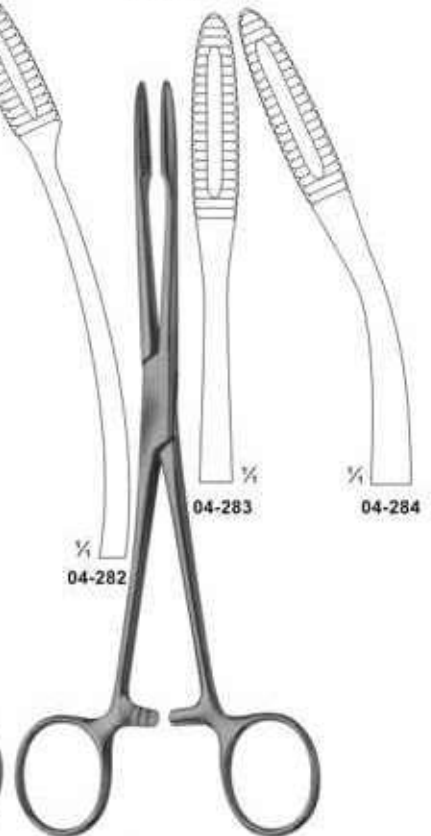

**04-283 - 04-284**  
GROSS  
200 mm

# Dressing-, Sponge holding-, Organ- and Tissue Grasping Forceps



1/2  
04-285  
195 mm



1/2  
04-286  
230 mm

04-285 - 04-286  
COLLIN

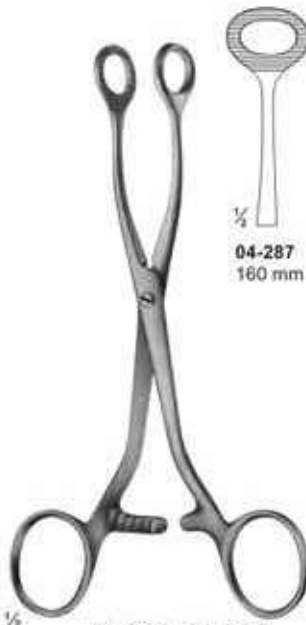

1/2  
04-287  
160 mm

1/2  
04-288  
160 mm

1/2  
04-289  
170 mm

04-287 - 04-289  
COLLIN

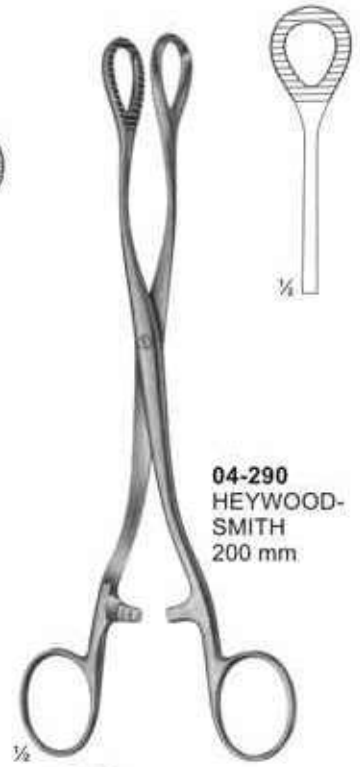

04-290  
HEYWOOD-  
SMITH  
200 mm



1/2  
04-291  
NOTO  
280 mm



1/2  
04-292  
KELLY  
320 mm



# Dressing, Sponge holding, Organ and Tissue Grasping Forceps

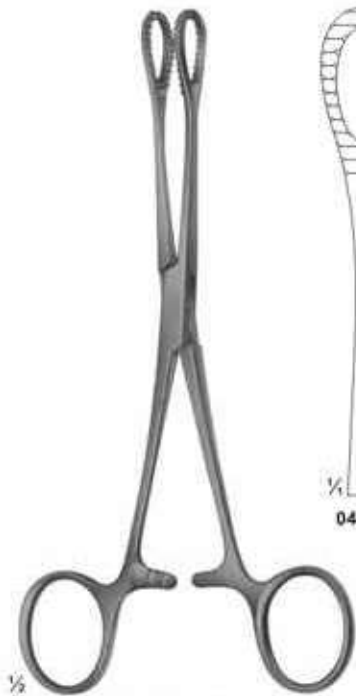

04-293



04-294

04-293 - 04-294  
FOERSTER-BALLENGER  
180 mm



04-295  
180 mm



04-296  
250 mm

04-295 - 04-296  
RAMPLEY



04-297  
Smooth Jaws



04-298  
Smooth Jaws

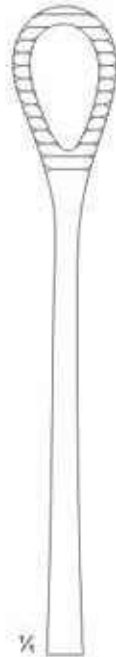

04-299  
Serrated Jaws



04-300  
Serrated Jaws



04-301

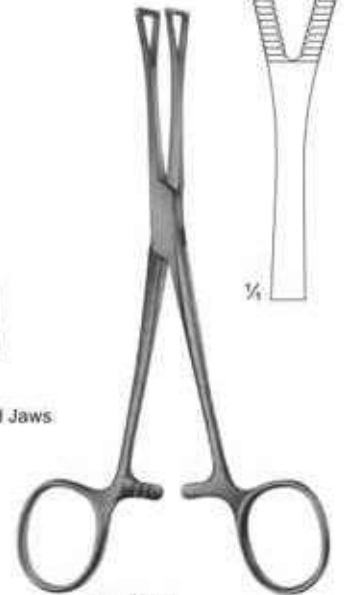

04-301  
PENNINGTON  
155 mm



## Intestinal Grasping Forceps

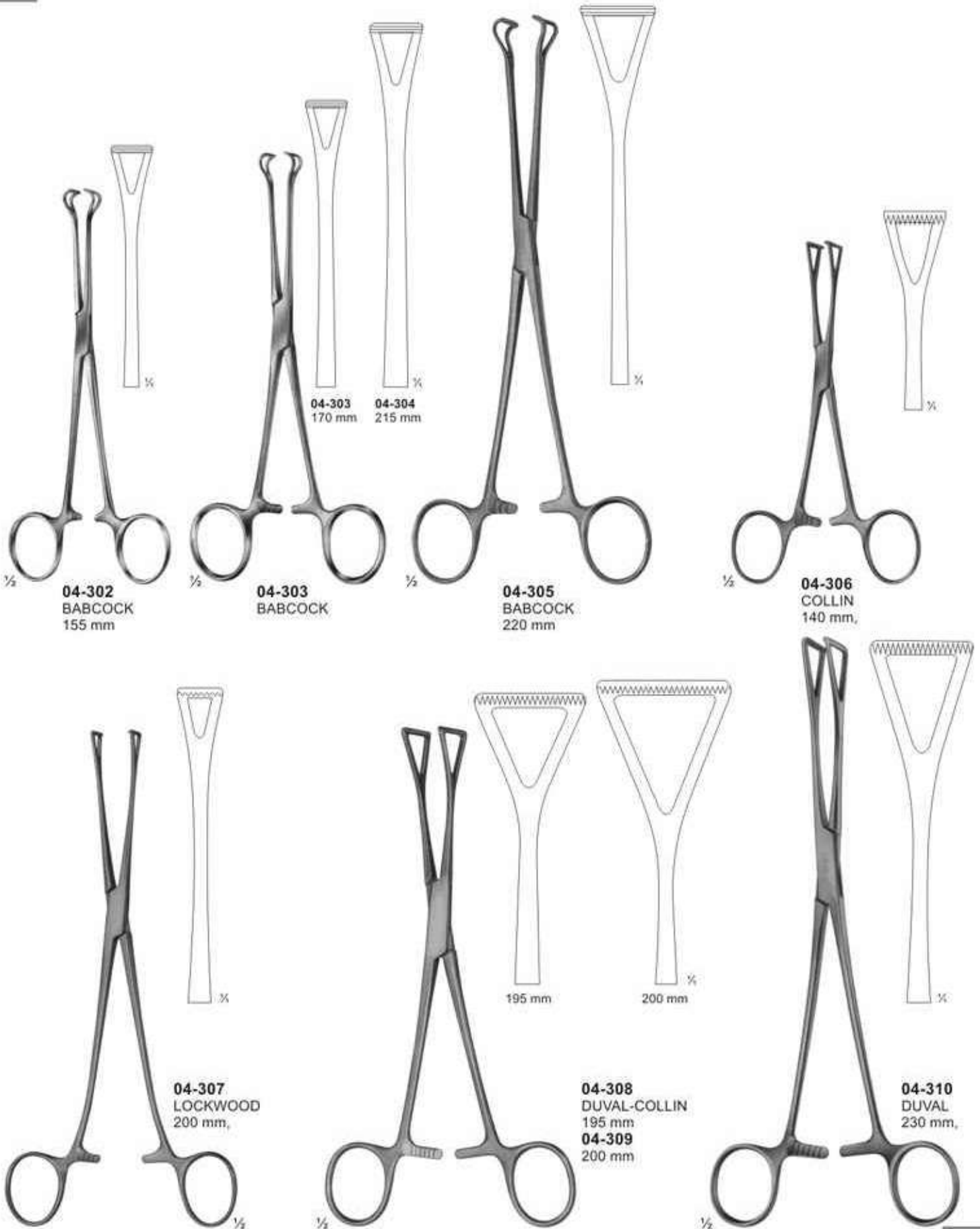

## Artery Traction - and Tissue Grasping Forceps

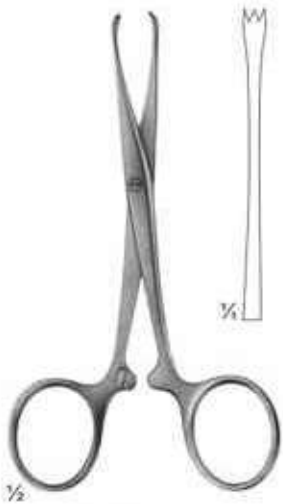

**04-311**  
CHAPUT  
2 x 3 teeth  
125 mm

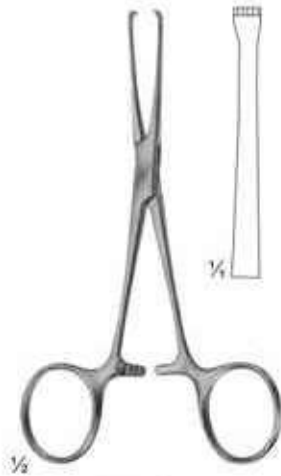

**04-312**  
BABY-ALLIS  
4 x 5 teeth  
130 mm



**04-313**  
BOYS-ALLIS  
5 x 6 teeth sharp  
155 mm

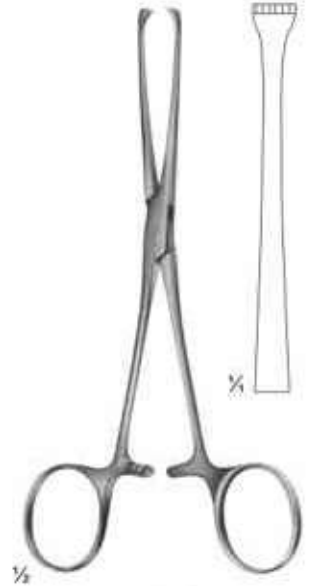

**04-314**  
ALLIS  
5 x 6 teeth  
155 mm



**04-315**  
LAHEY  
155 mm

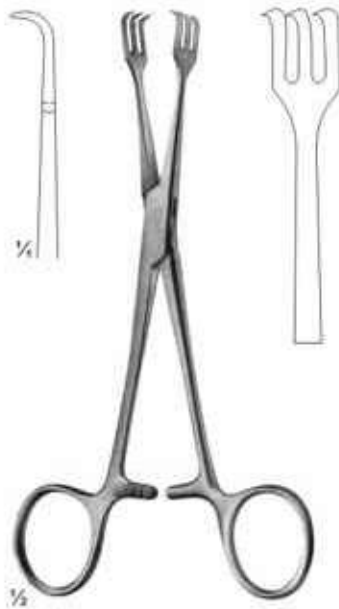

**04-316**  
LAHEY  
155 mm

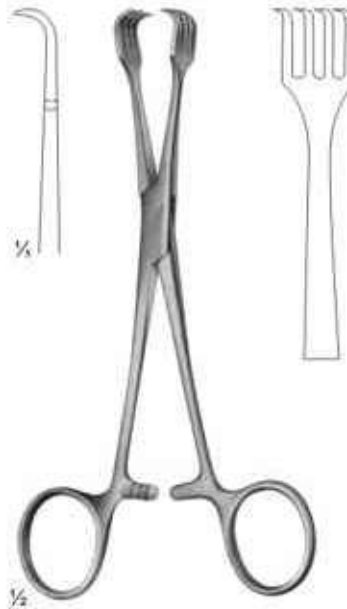

**04-317**  
BRAUN  
155 mm

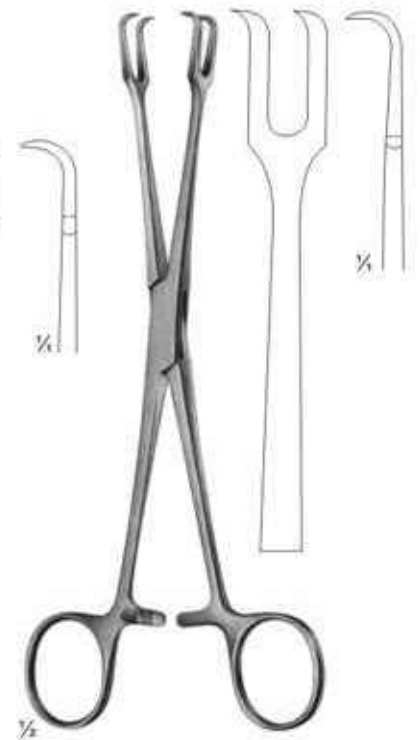

**04-318**  
MUSEUX  
200 mm

# Towel Clamps



**04-319**  
JONES  
85 mm



**04-320**  
ENGL. MOD.  
85 mm

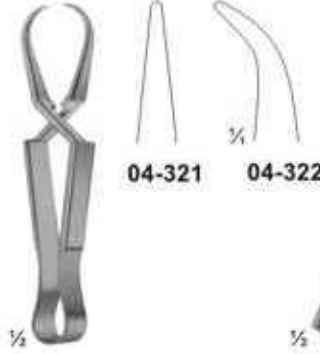

**04-321 - 04-322**  
SCHAEDEL  
85 mm



**04-323**  
DOYEN  
110 mm



**04-324**  
DOYEN  
180 mm

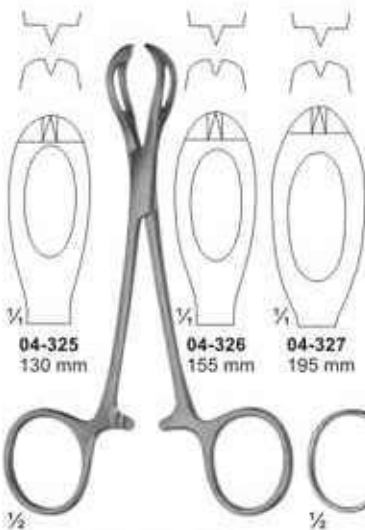

**04-325 - 04-327**  
LANE

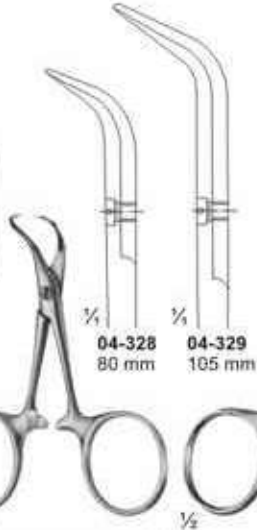

**04-328 - 04-329**  
BACKHAUS

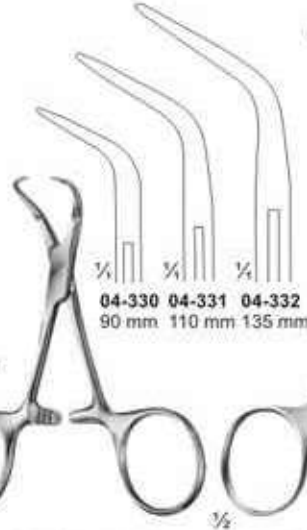

**04-330 - 04-332**  
BACKHAUS

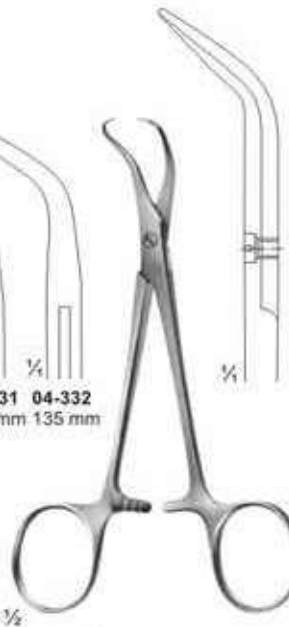

**04-333**  
BACKHAUS-KOCHER  
135 mm

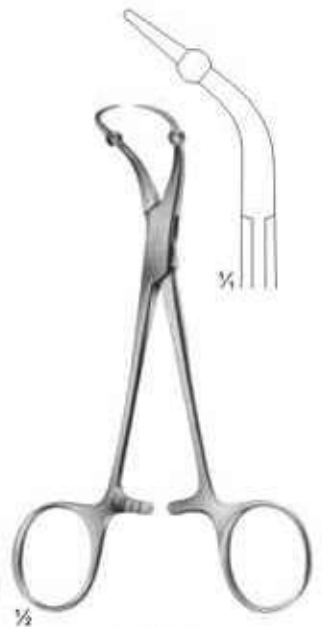

**04-334**  
ROEDER  
135 mm

# Muller Vessel Clips and Bulldog Clamps

## Closing force

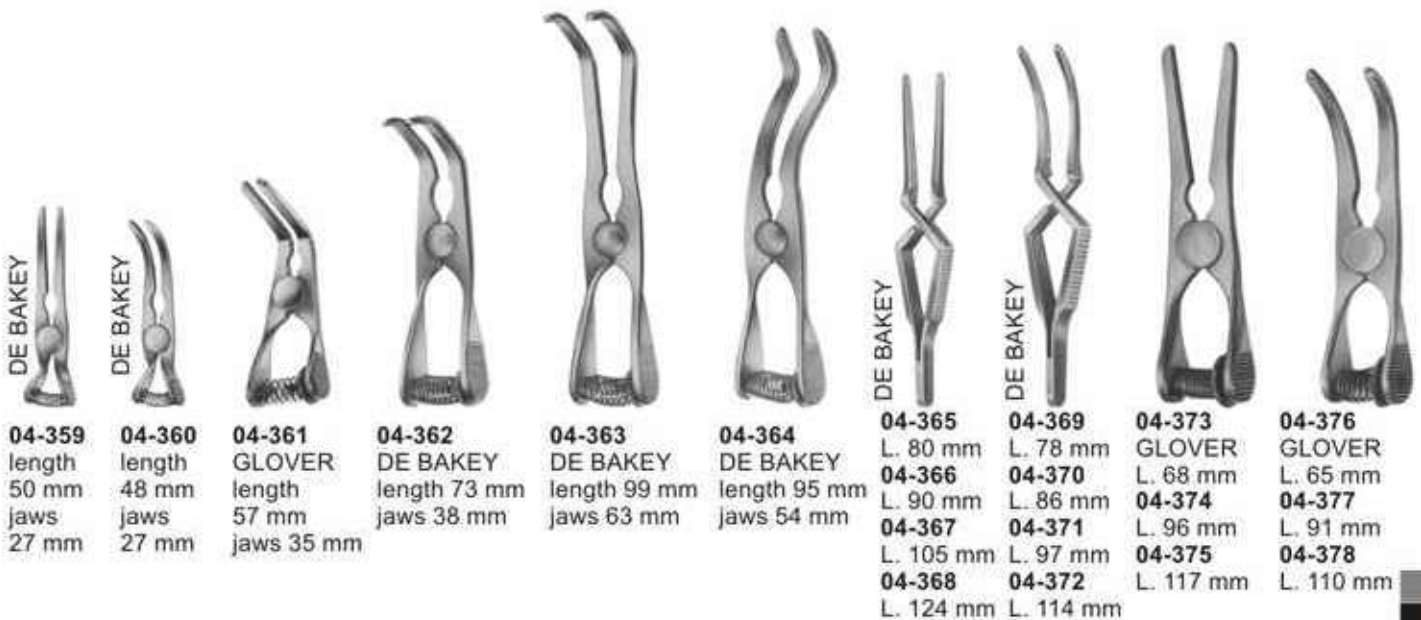
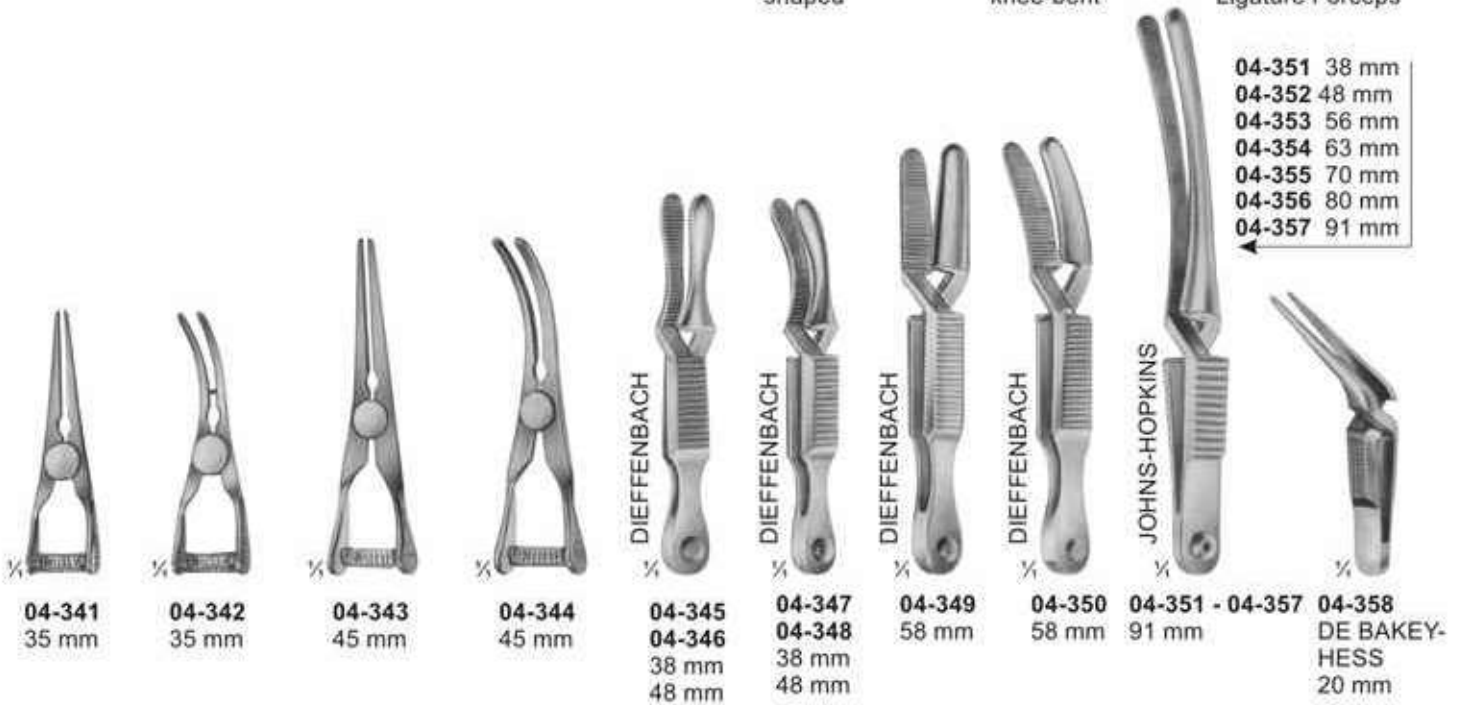
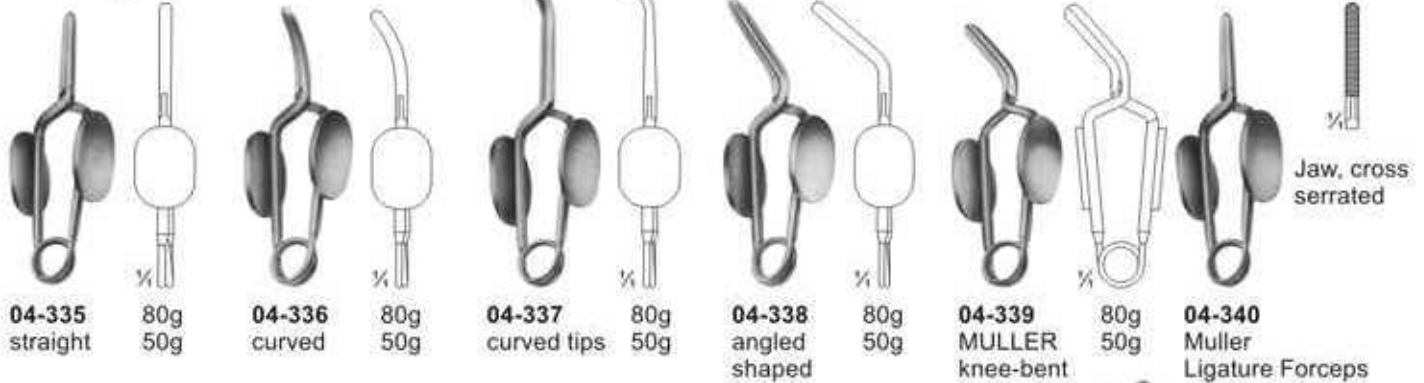

# Delicate Haemostatic Forceps

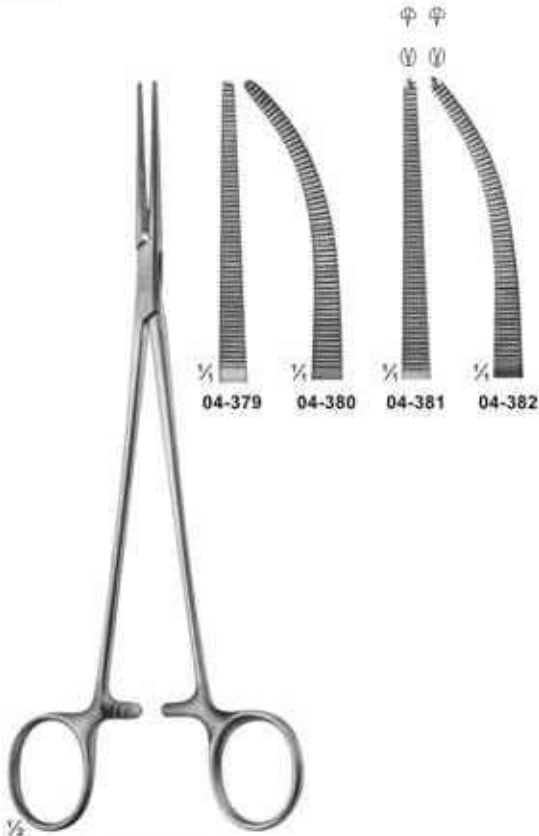

04-379 - 04-382  
HALSTED-MOSQUITO  
200 mm

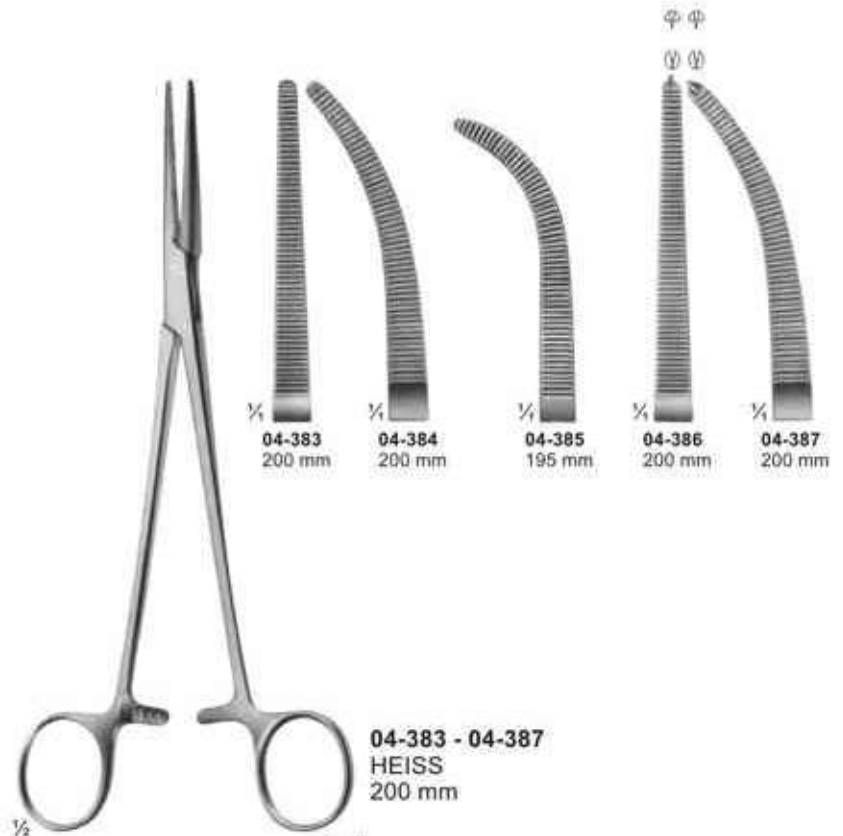

04-383 - 04-387  
HEISS  
200 mm



04-388 - 04-389  
HALSTED  
215 mm

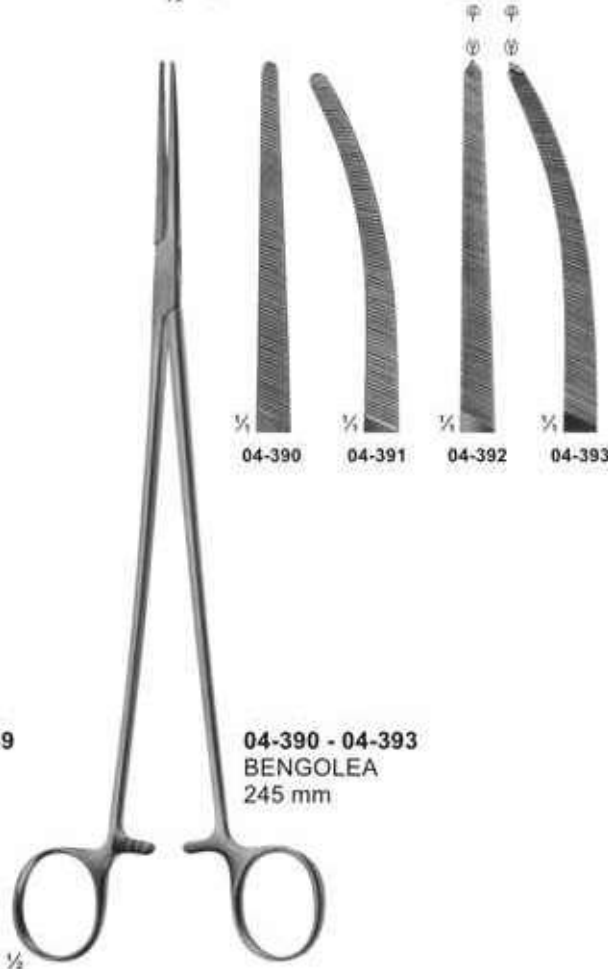

04-390 - 04-393  
BENGOLEA  
245 mm



04-394  
CRAFOORD  
245 mm

## Delicate Haemostatic Forceps



**04-395**  
 CARREL  
 85 mm



**04-396 - 04-399**  
 BABY-MOSQUITO  
 (HARTMANN)  
 100 mm



**04-400 - 04-403**  
 MICRO-HALSTED  
 125 mm



**04-404 - 04-407**  
 HALSTED-MOSQUITO  
 125 mm

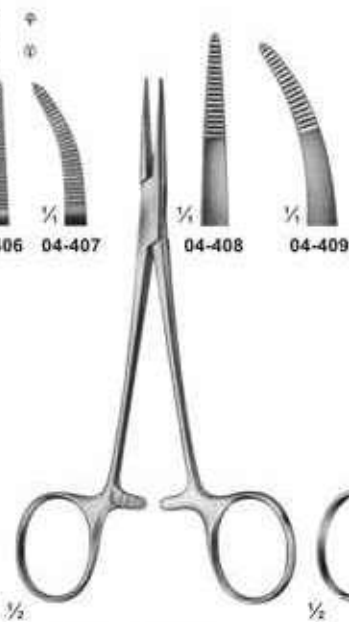

**04-408 - 04-409**  
 PROVIDENCE-HOSPITAL  
 140 mm



**04-410 - 04-411**  
 KELLY  
 140 mm

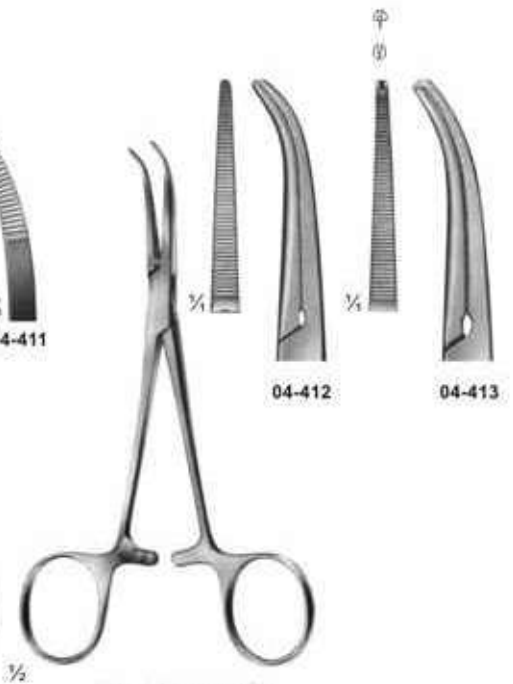

**04-412 - 04-413**  
 DANDY  
 Curved sideways  
 140 mm

## Delicate Haemostatic Forceps

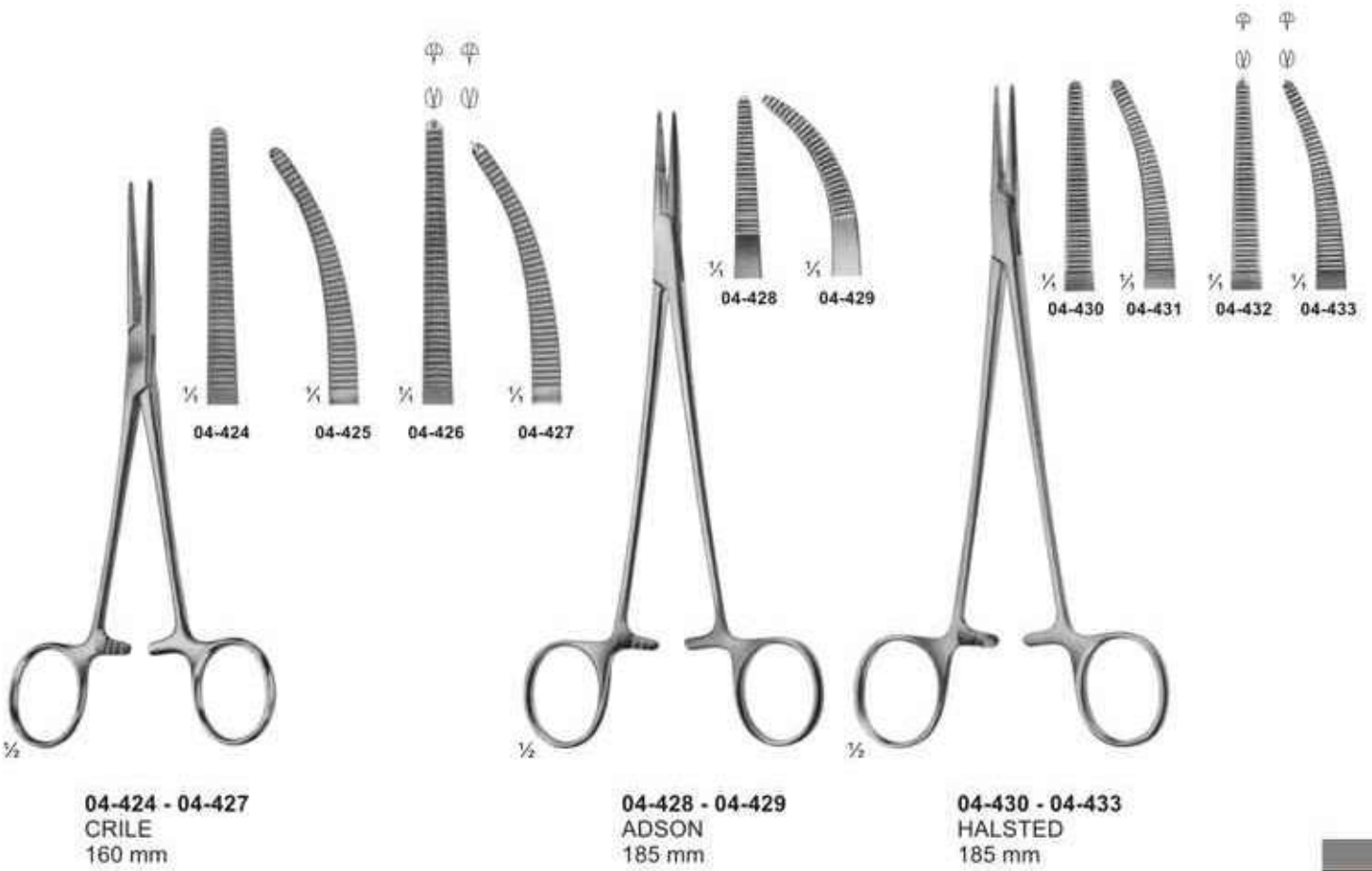
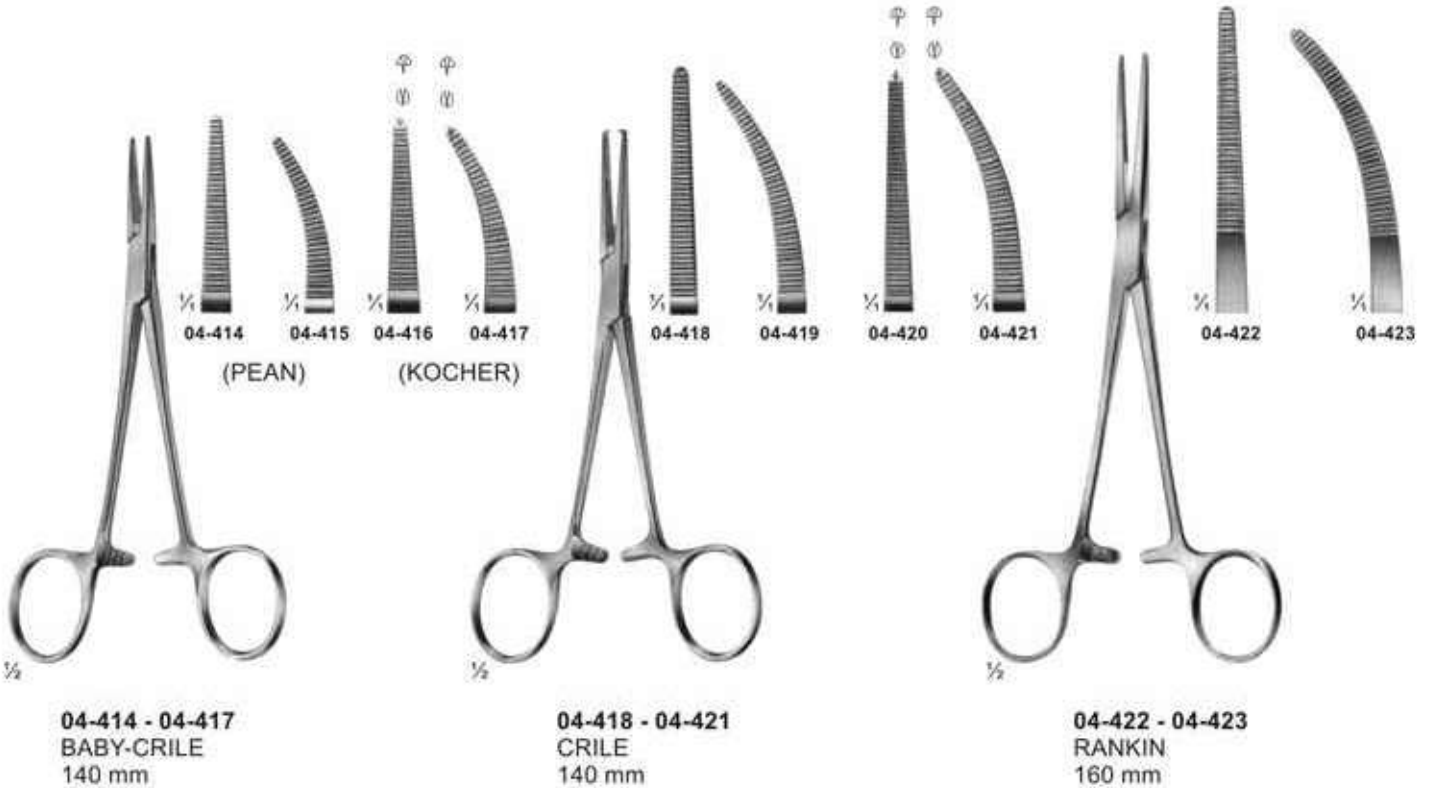



# Haemostatic Forceps

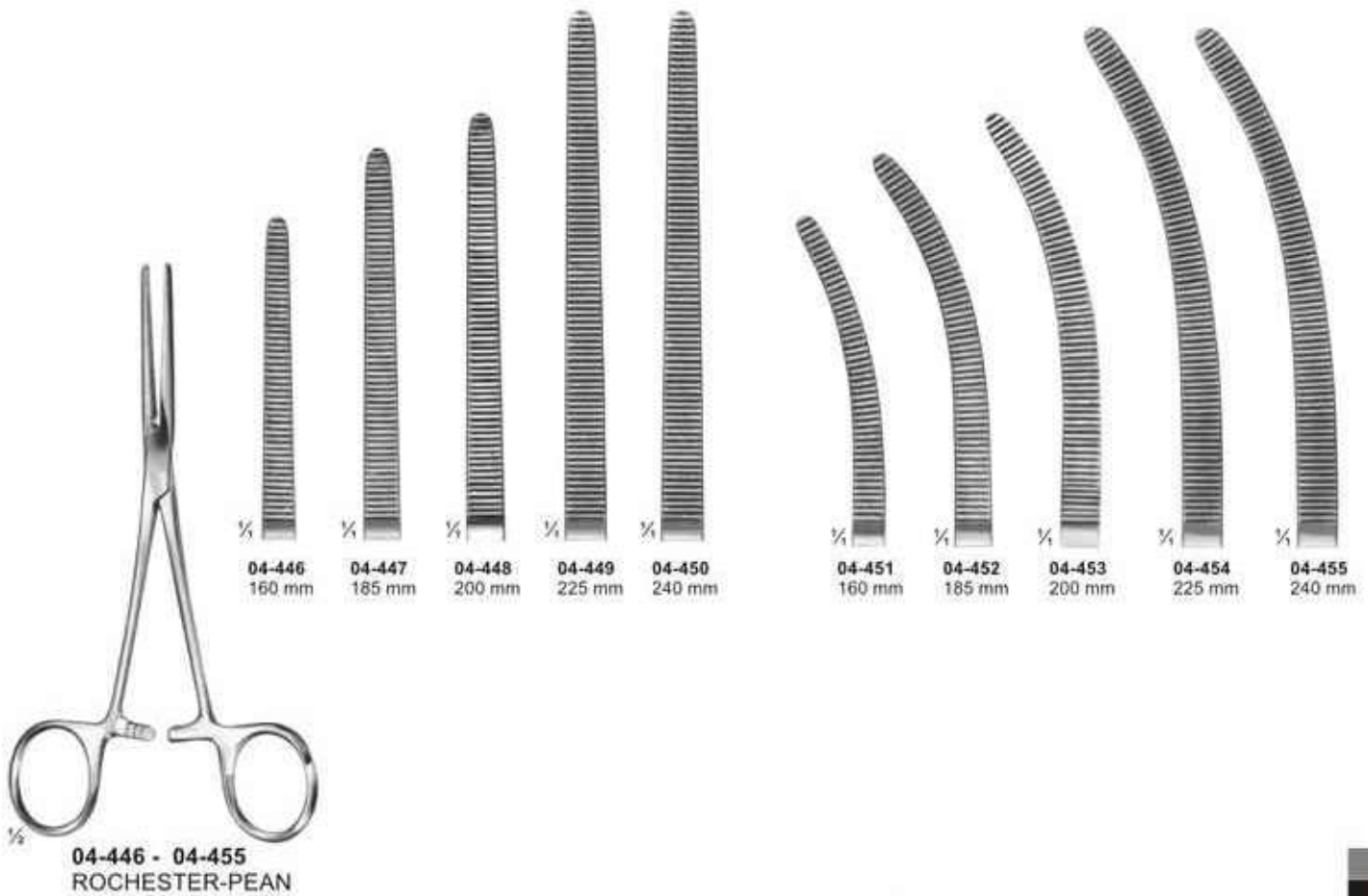

# Haemostatic Forceps



04-456 - 04-461  
PEAN

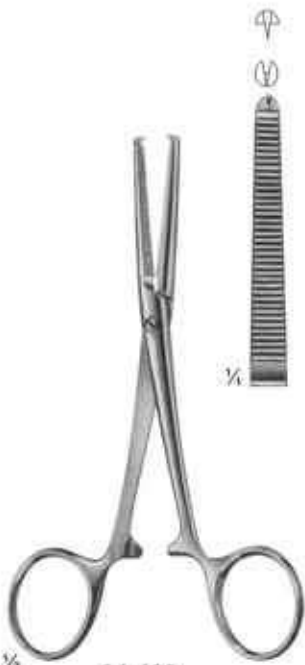
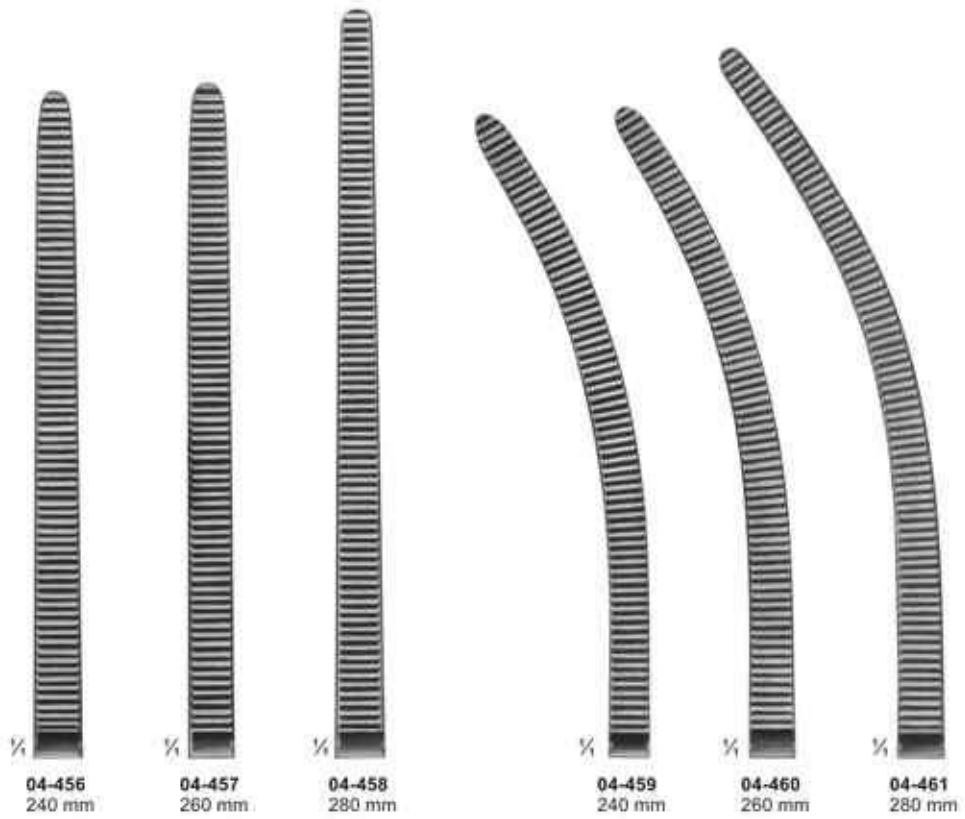

04-462  
KOCHER  
Strong Pattern  
145 mm

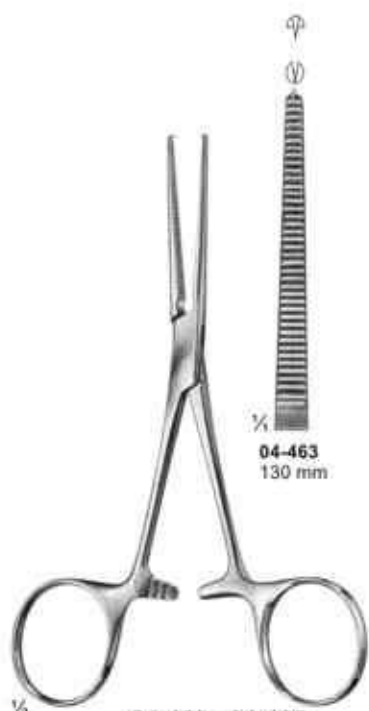

04-463 - 04-465  
KOCHER

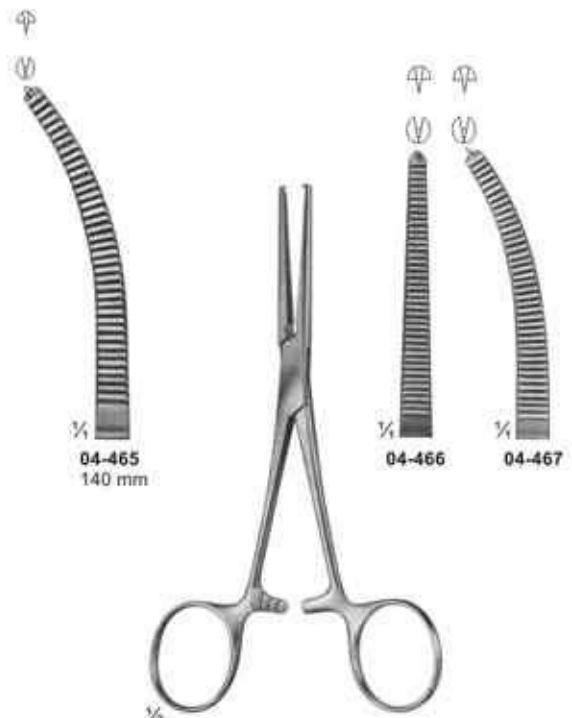

04-466 - 04-467  
ROCHESTER-OSHSNER  
140 mm

# Haemostatic Forceps

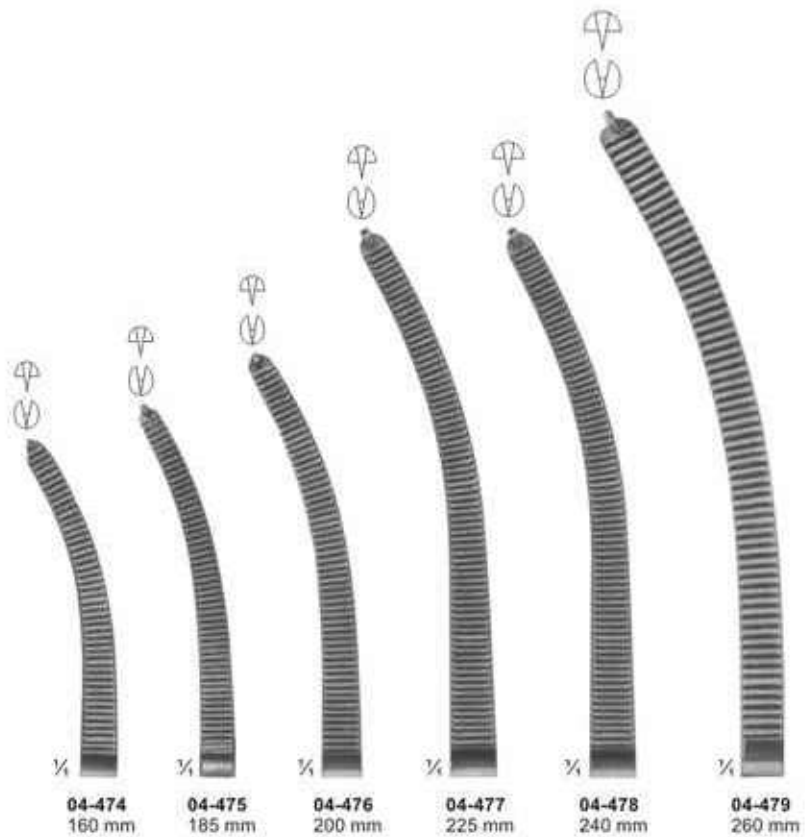
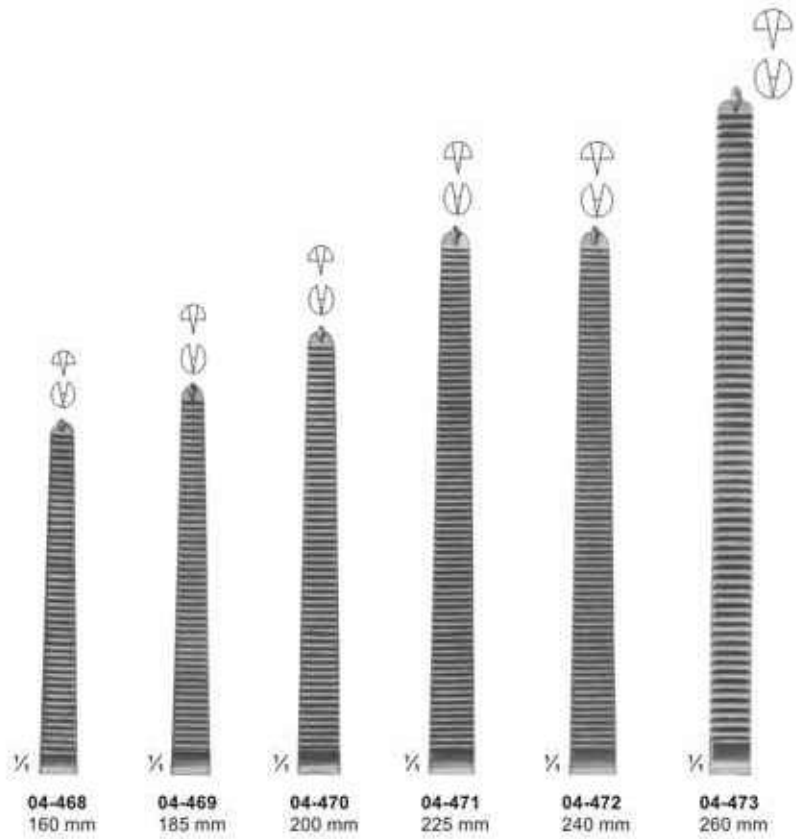

04-468 - 04-479  
KOCHER-OCHSNER

# Haemostatic Forceps

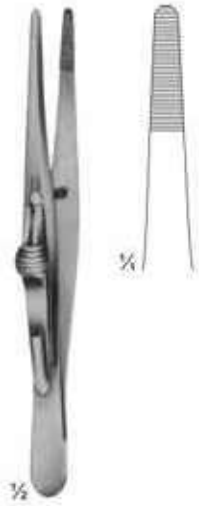

**04-480**  
**FRICKE**  
Artery forceps  
130 mm



**04-481**  
**KRONLEIN**  
130 mm



**04-482**  
**PEAN**  
125 mm



**04-483**  
125 mm



**04-484**  
140 mm

**04-483 - 04-484**  
**PEAN**



**04-485**  
**PEAN**  
125 mm



**04-486**  
165 mm



**04-487**  
185 mm

**04-486 - 04-487**  
**PEAN**

# Haemostatic Forceps, Special Pattern, Tonsil Forceps

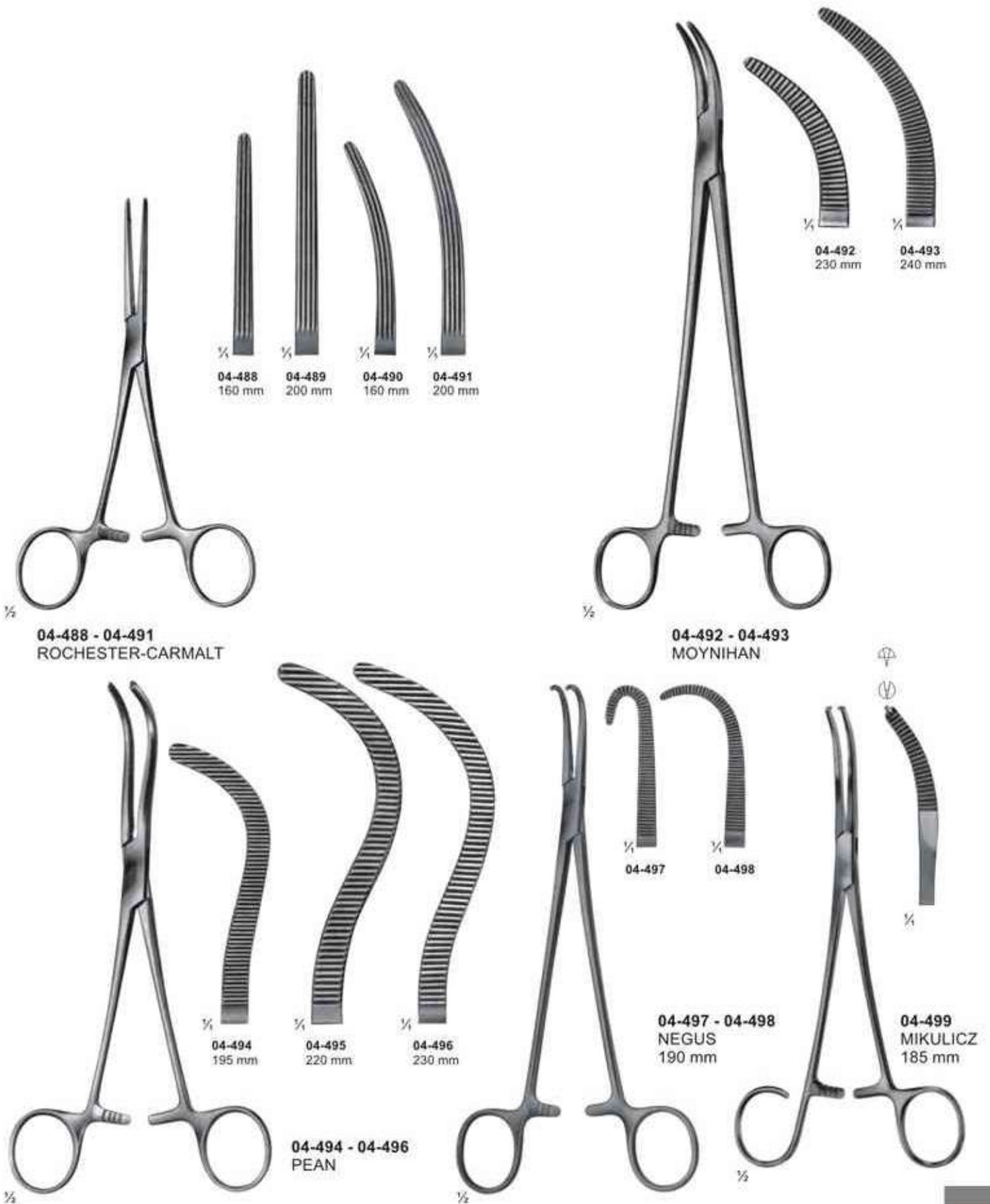

## Dissecting- and Ligature Forceps



1/2  
**04-500**  
 MIXTER-O'SHAUGHNESSY  
 190 mm



1/2  
**04-501**  
 HEISS  
 195 mm

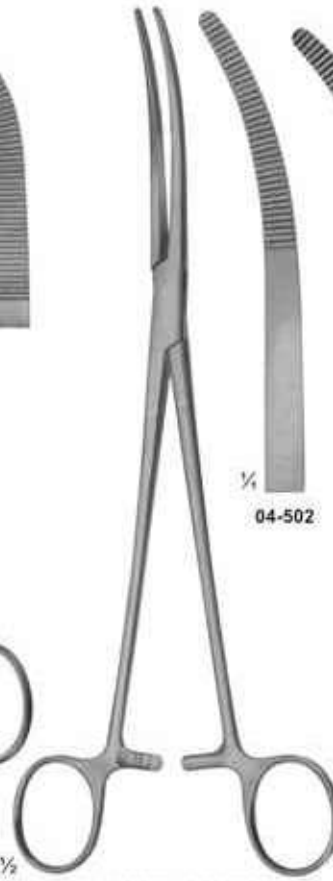

1/2  
**04-502 - 04-506**  
 RUMEL  
 240 mm

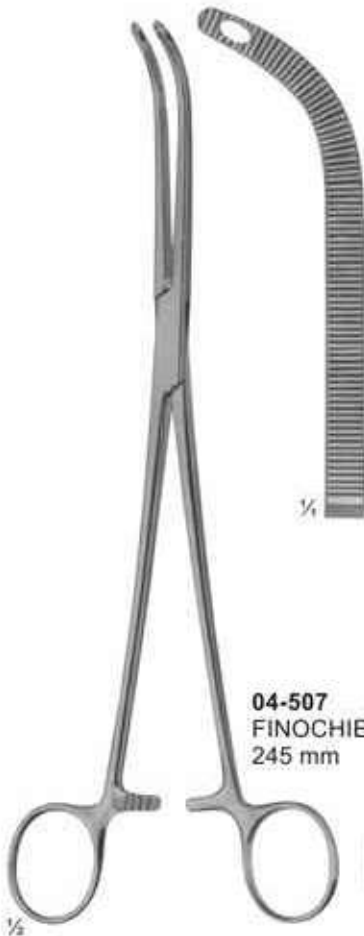

**04-507**  
 FINOCHIETTO  
 245 mm



**04-508**  
 MIXTER  
 230 mm



**04-509**  
 LAWRENCE  
 270 mm

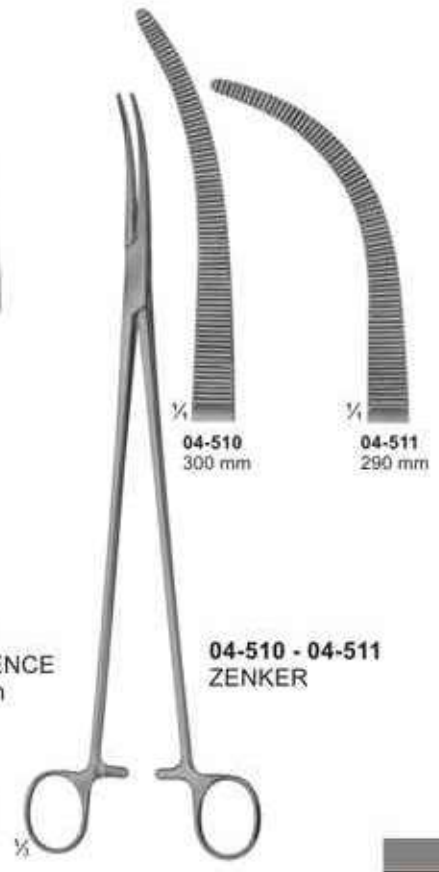

**04-510 - 04-511**  
 ZENKER  
 300 mm / 290 mm

# Hysterectomy Forceps, Vaginal Clamps and Compression Forceps



04-512  
WERTHEIM  
Hysterectomy forceps  
255 mm



04-513  
WERTHEIM  
Parametrium clamp  
260 mm

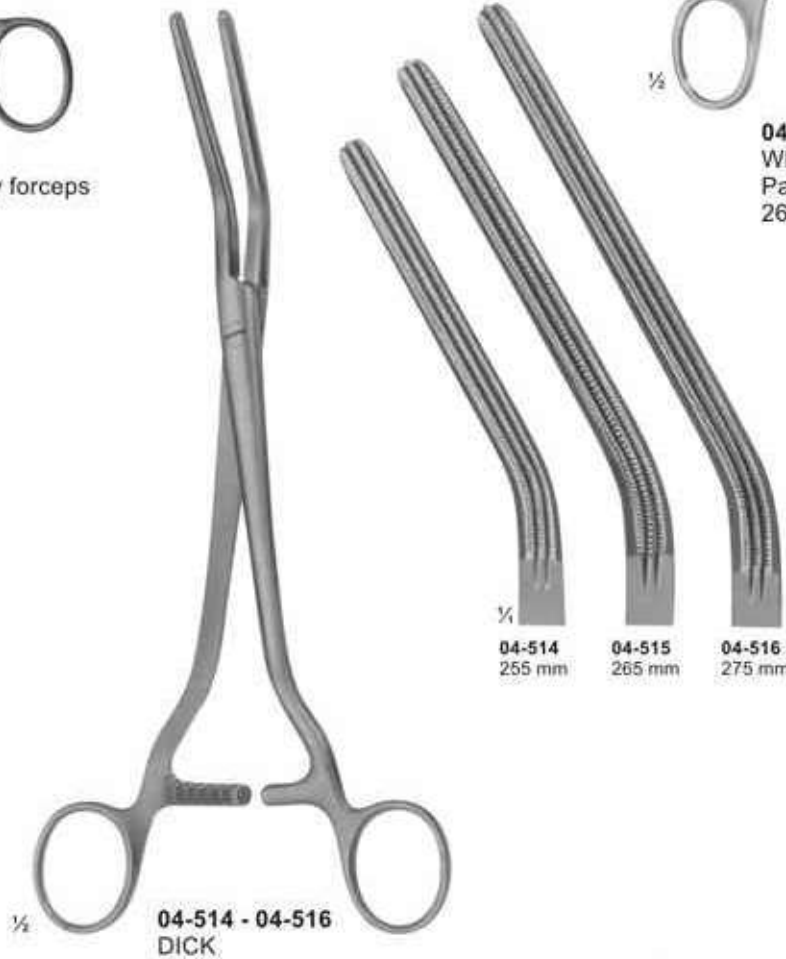

04-514 - 04-516  
DICK

04-514 255 mm  
04-515 265 mm  
04-516 275 mm

Hysterectomy Forceps, Vaginal Clamps  
and Compression Forceps





## Needle Holders for micro surgery



**05-101**  
**ROHRSCHEIDER**  
 with copper inserts  
 100 mm



**05-102**  
**KALT**  
 with catch  
 135 mm



**05-103**  
**ARRUGA**  
 with catch  
 135 mm



**05-104 - 105**  
**CASTROVIEJO**  
 with catch  
 145 mm



**05-106 - 107**  
 without Catch  
 160 mm



**05-108 - 109**  
 without catch  
 185 mm

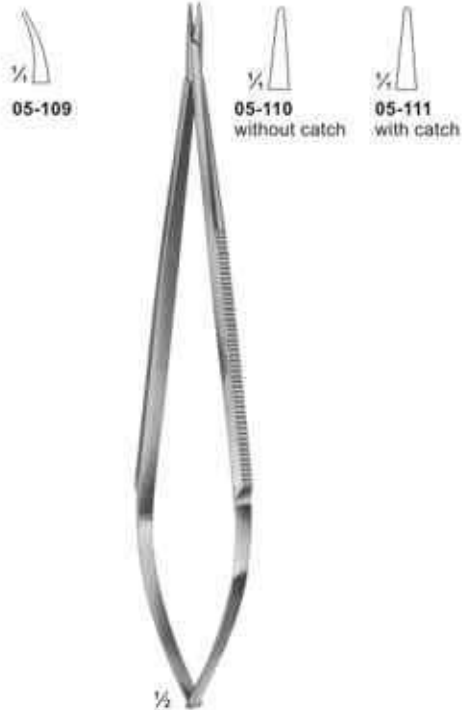

**05-110 - 111**  
**JACOBSON**  
 185 mm



**05-112**  
 without catch  
 195 mm



**05-113 - 114**  
**YASARGIL**  
 with catch  
 200 mm

# Needle Holders



# Needle Holders

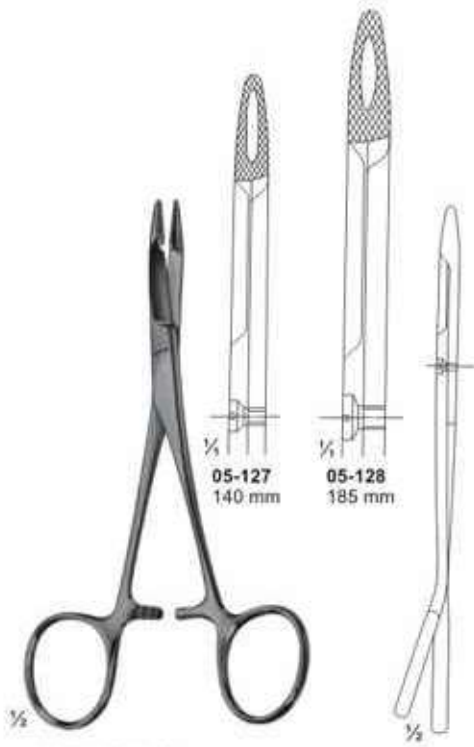

**05-127 - 128**  
**HEGAR-OLSEN**  
255 mm

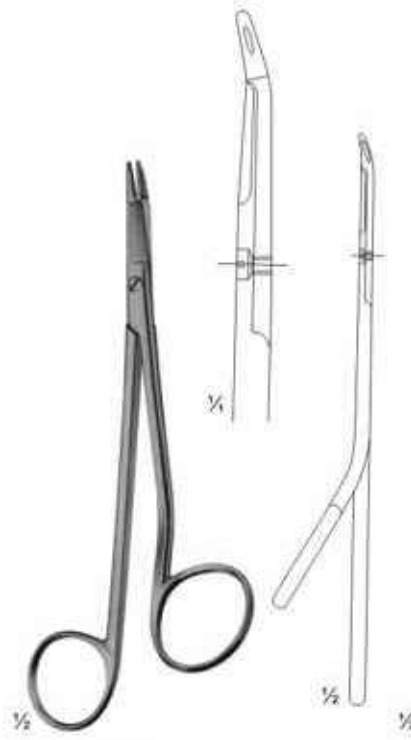

**05-129**  
**GILLIES**  
150 mm

**05-130**  
**GILLIES**  
160 mm



**05-131**  
**EISELSBERG**  
115 mm

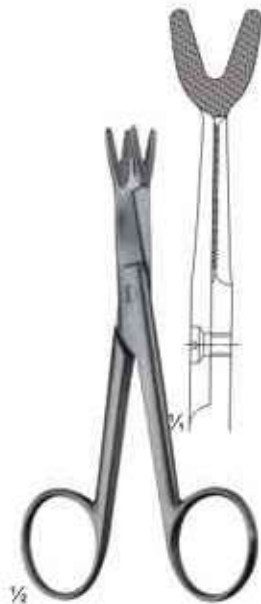

**05-132**  
**SCHOEMAKER-LOTH**  
125 mm



**05-133**  
**CRILE**  
150 mm



**05-134**  
**TOENNIS**  
Elastic pattern for dura-or  
intestinal suture. 180 mm

## Needle Holders

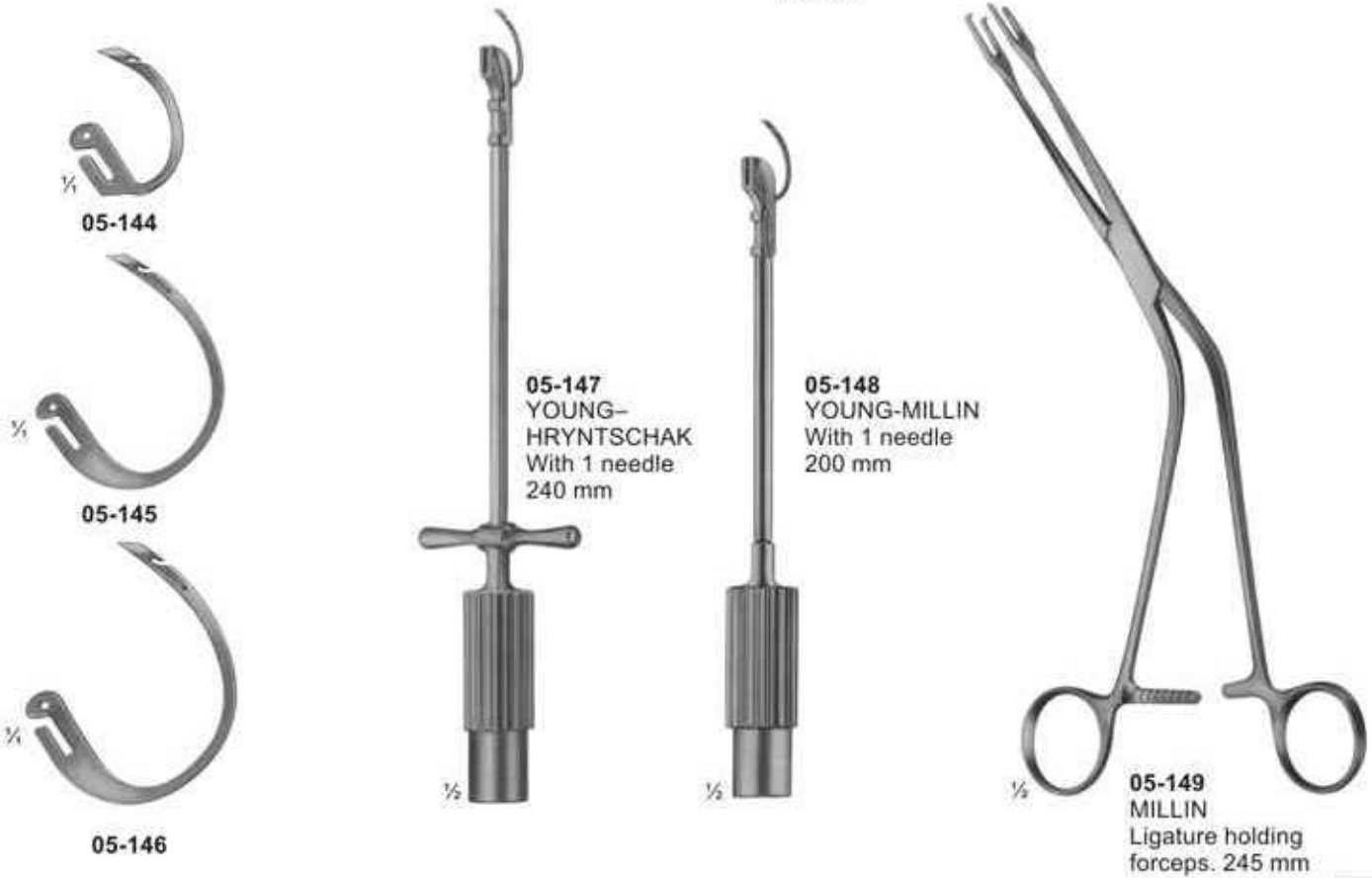
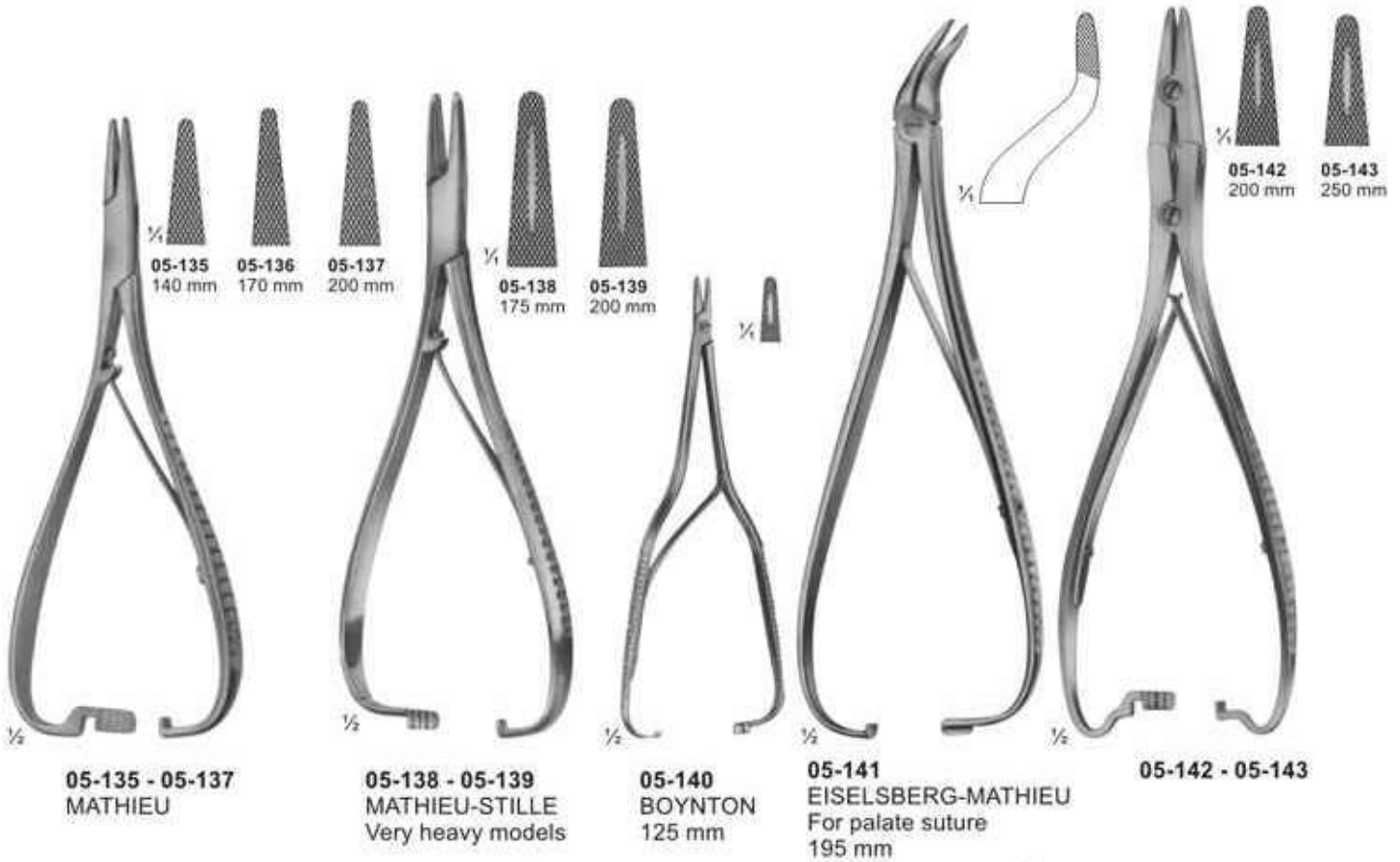

## Suture Instruments - Reverdin Needles

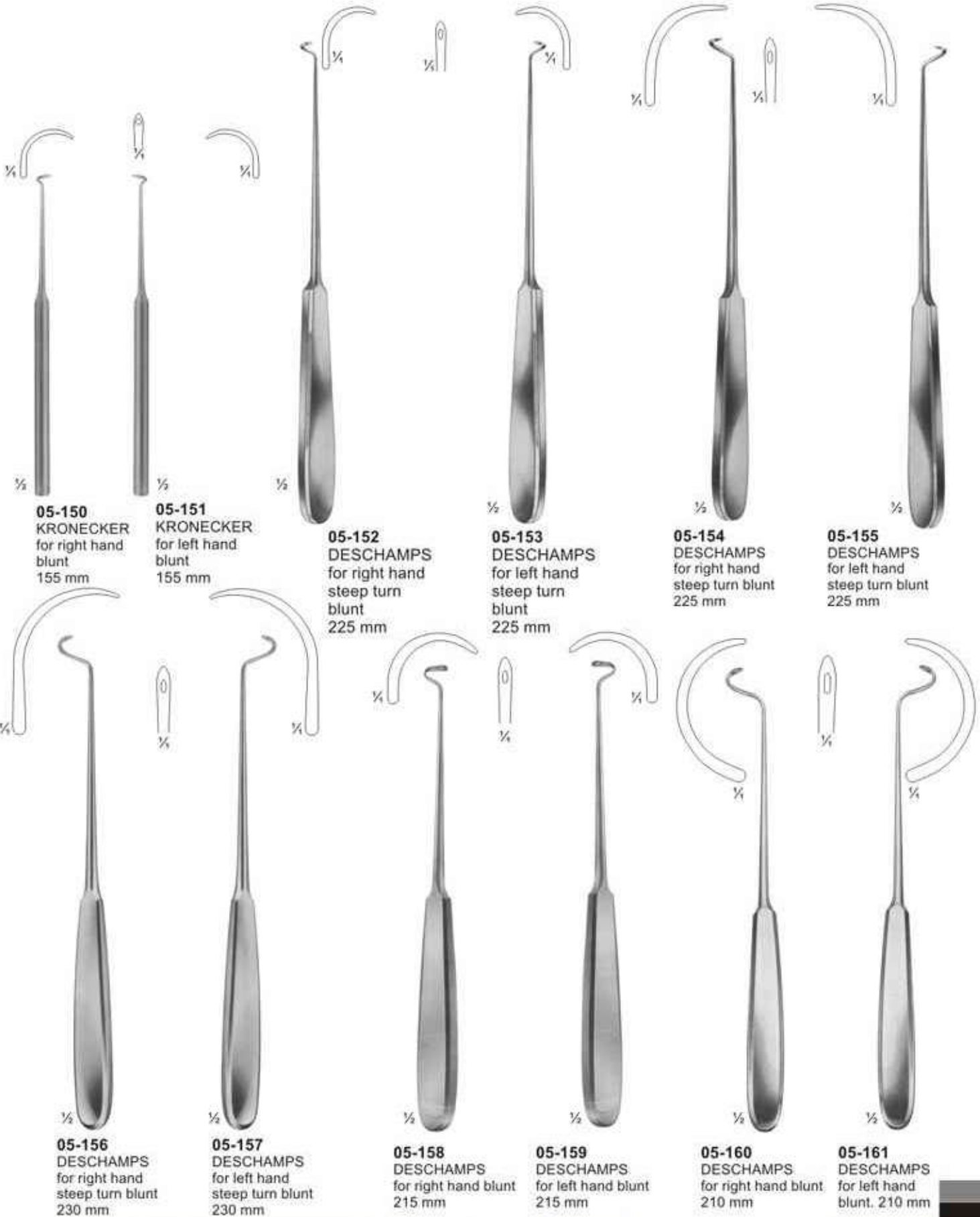

# Probes



05-162 130 mm  
05-163 145 mm  
05-164 160 mm  
Directors



05-165  
DOYEN  
145 mm  
Directors



05-166  
NELATON  
160 mm  
Directors



05-167  
Director with tip  
Diam. Of tip 3,3 mm  
140 mm

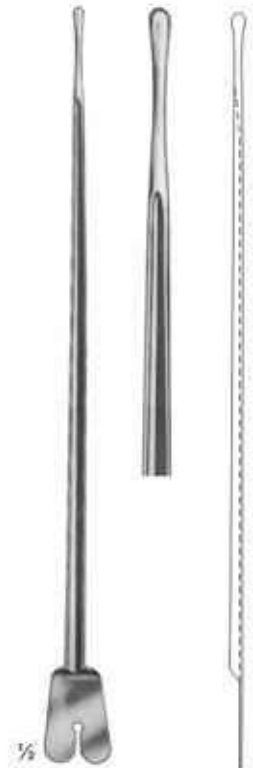

05-168  
BRODIE  
Director with tip,  
Diam. Of tip 3,5 mm  
200 mm

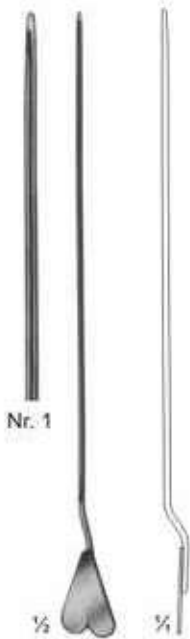

05-169  
LOCKHART-MUMMERY  
165 mm



05-170  
LOCKHART-MUMMERY  
165 mm

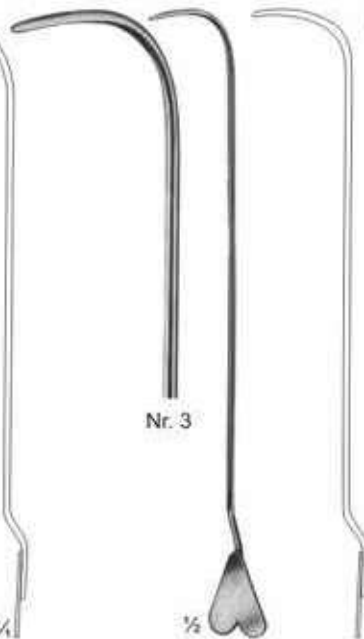

05-171  
LOCKHART-MUMMERY  
165 mm

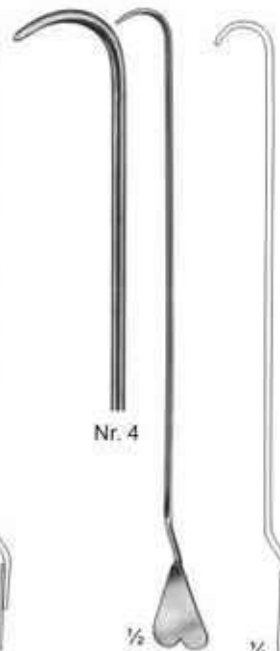

05-172  
LOCKHART-MUMMERY  
165 mm



05-173  
Director with wire  
loop, malleable  
190 mm

# Probes



05-174 2,5 mm  
05-175 2,5 mm  
05-176 3,0 mm

05-174 145 mm  
05-175 160 mm  
05-176 200 mm  
Probes with eye



1,5 mm

05-177  
Myrtle leaf probe  
145 mm



2,0 mm

05-178 130 mm  
05-179 145 mm  
05-180 160 mm  
05-181 180 mm  
05-182 200 mm



05-183  
Probes



05-184  
Double ended probe,  
malleable, diam. of tips  
3 mm with hole  
190 mm



05-185  
Double ended probes,  
tin, malleable,  
diam. of tips  
3,5 mm with hole  
250 mm, 300 mm



05-186  
Double ended probes,  
tin, malleable,  
diam. of tips 4 mm  
400 mm



05-187 1,5 mm  
05-188 2,0 mm  
05-189 2,5 mm  
300 mm

## Suturing Instrument Set, Pocket Instrument Set



### 05-190

Suturing instruments set, in metal case consisting of: Scissors, curved, sharp/sharp, 115mm  
25 MICHEL clip, 16 x 3mm  
1 Delicate tissue forceps, 130mm  
1 Scalpel, bellied  
1 MATHIEU needle holder, 140mm  
1 Perforated metal case, stainless containing:  
1 Suture needle  
1 item 1 item



### 05-191

Pocket instrument set, in metal case consisting of:

#### Bottom tray

1 MATHIEU needle holder, 140mm  
1 MICHEL clip forceps, combined  
1 Myrtle leaf probe, 130mm  
1 Sharp double curette  
1 Skin hook  
1 Detachable scalpel handle, no.4  
1 Perforated metal case, containing  
6 Scalpel blades  
1 Perforated metal case, stainless, containing  
1 Suture needle  
1 item  
1 item

#### Top tray

1 Tissue forceps, 130mm  
1 KOCHER haemostatic forceps, 130mm  
1 Straight surgical scissors, 130mm  
1 Dissecting forceps, 130mm  
1 FEILCHENFELD splinter forceps, 115mm  
25 MICHEL clip, 16 x 3mm  
1 Flacon of suture skin, sterile in alcohol



### 05-192

Pocket instrument set, in metal case consisting of:

#### Bottom tray

1 MAYO-HEGER needle holder, 150mm  
1 MICHEL clip forceps, combined  
1 Myrtle leaf probe, 130mm  
1 Sharp double curette  
1 Skin hook  
1 Detachable scalpel handle, no. 4  
1 Perforated metal case, consisting  
6 Scalpel blades  
1 Perforated metal case, stainless, consisting:  
1 Suture needle  
1 item, & 1 item

#### Top tray

1 Tissue forceps, 130mm  
1 CRILE haemostatic forceps, 140mm  
1 Straight surgical scissors, 130mm  
1 Dissecting forceps, 130mm  
1 FEILCHENFELD splinter forceps, 115mm  
25 MICHEL clip, 16 x 3mm  
1 Flacon of suture silk, sterile in alcohol





## Fine Wound Retractors (Dura- and Skin Retractors)

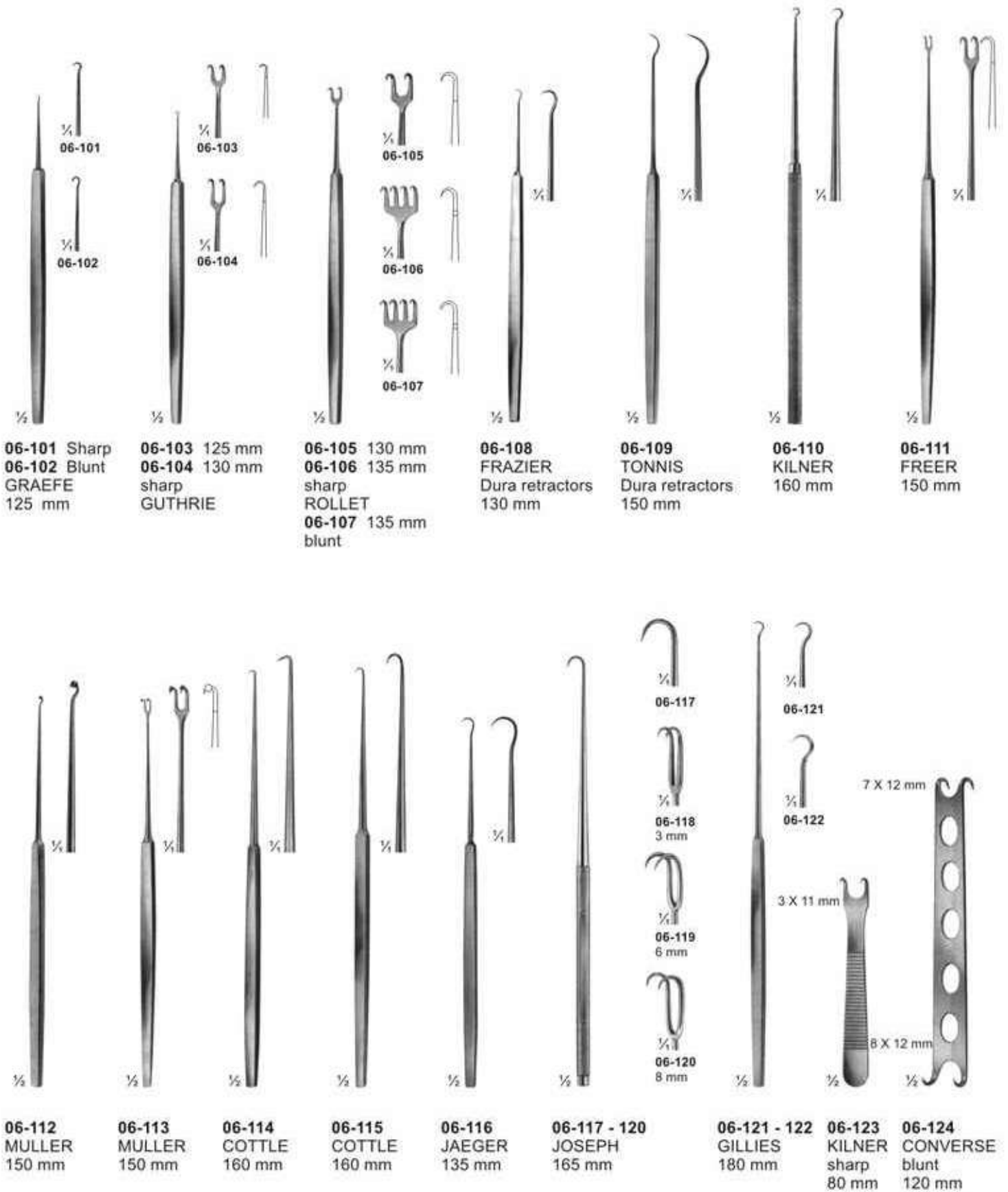

## Retractors With treangle handle

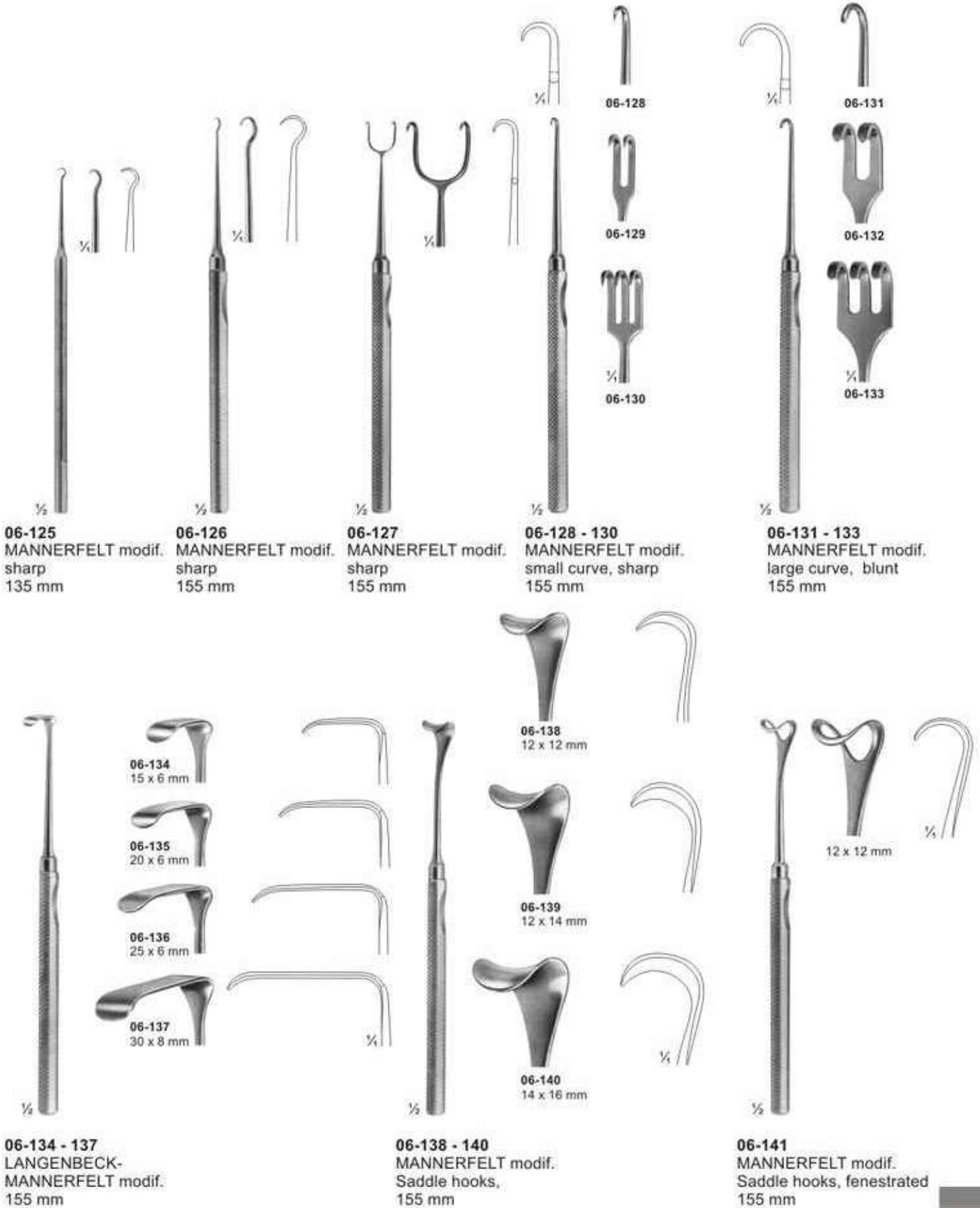

# Retractors



$\frac{1}{4}$ 
  
 6 x 12 mm

**06-142**  
 MASING  
 140 mm



$\frac{1}{4}$ 
  
 10 x 12 mm

**06-143**  
 COTTLE  
 140 mm



**06-144**  
 9 x 9 mm



**06-145**  
 9 x 12 mm

**06-144 - 148**  
 DESMARRES  
 140 mm



$\frac{1}{4}$ 
  
**06-146**  
 11 x 14 mm



$\frac{1}{4}$ 
  
**06-147**  
 12 x 16 mm



$\frac{1}{4}$ 
  
**06-148**  
 13 x 18 mm



$\frac{1}{4}$ 
  
**06-149**  
 13 x 13 mm



$\frac{1}{4}$ 
  
**06-150**  
 12 x 16 mm

$\frac{1}{2}$ 
  
**06-149 - 150**  
 KONIG  
 180 mm



$\frac{1}{4}$ 
  
 10 x 10 mm

$\frac{1}{2}$ 
  
**06-151**  
 CUSHING-KOCHER  
 175 mm



$\frac{1}{2}$ 
  
**06-152 - 153**  
 KOCHER  
 205 mm



$\frac{1}{4}$ 
  
**06-152**  
 20 x 12 mm



$\frac{1}{4}$ 
  
**06-153**  
 20 x 15 mm



$\frac{1}{2}$ 
  
**06-154**  
 SCHOENBORN  
 200 mm



$\frac{1}{4}$ 
  
 13 x 6 mm



$\frac{1}{4}$ 
  
**06-155**  
 10 x 13 mm



$\frac{1}{4}$ 
  
**06-156**  
 14 x 18 mm

$\frac{1}{2}$ 
  
**06-155 - 156**  
 CUSHING  
 205 mm



$\frac{1}{2}$ 
  
**06-157**  
 205 mm



$\frac{1}{4}$ 
  
**06-158**  
 11 x 14 mm



$\frac{1}{4}$ 
  
**06-159**  
 13 x 18 mm



$\frac{1}{4}$ 
  
**06-160**  
 15 x 22 mm

$\frac{1}{2}$ 
  
**06-158 - 160**  
 CUSHING  
 250 mm

## Retractors



## Retractors



## Bone Retractors and Retractors



06-184  
KOCHER  
sharp  
205 mm



06-185  
KOCHER  
sharp  
220 mm



06-186  
KOCHER  
sharp  
220 mm



06-187  
VOLKMANN  
blunt  
220 mm



06-188  
VOLKMANN  
sharp  
220 mm



06-189 - 06-196  
VOLKMANN  
225 mm



06-189  
9 x 8 mm



06-190  
9 x 13 mm



06-191  
9 x 19 mm



06-192  
9 x 29 mm



06-193  
8,5 x 8 mm



06-194  
8,5 x 13 mm



06-195  
8,5 x 19 mm



06-196  
8,5 x 29 mm

# Retractors

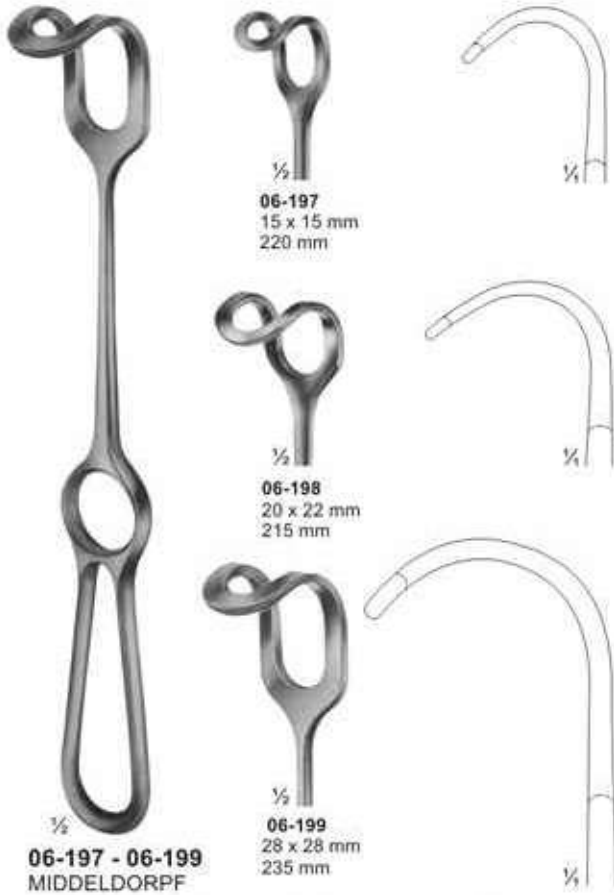

1/2  
**06-197 - 06-199**  
MIDDELDORPF

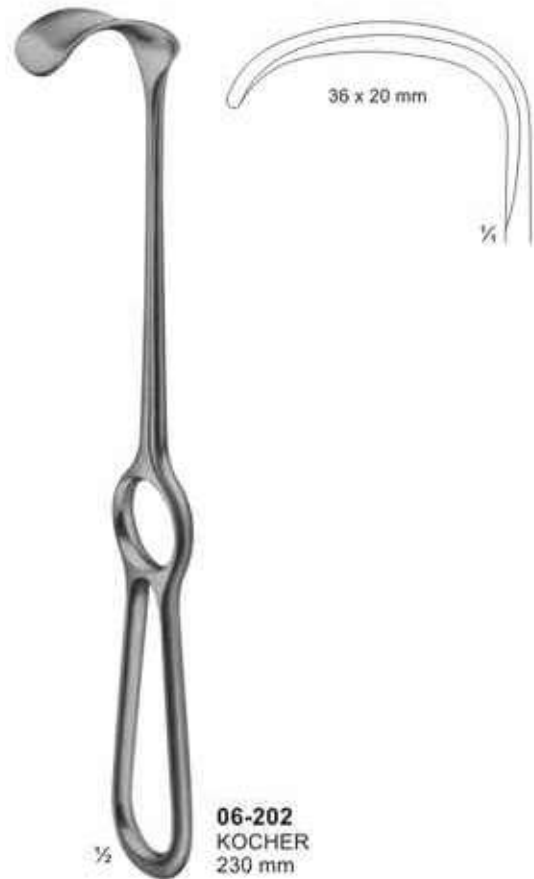

# Retractors, Vario Retractor System



06-203 80 x 20 mm



06-203-06-209  
BRUNNER  
275 mm

- 06-203 80 x 20
- 06-204 100 x 25
- 06-205 120 x 25
- 06-206 130 x 30
- 06-207 140 x 30
- 06-208 160 x 30
- 06-209 180 x 30



06-210  
Handle with cold  
light carrier for  
retractor blades.  
280 mm



Handle arrange-  
ment verriable



# Retractors, Lung Spatulas



Retractors for deep surgery  
(Abdominal Retractors)

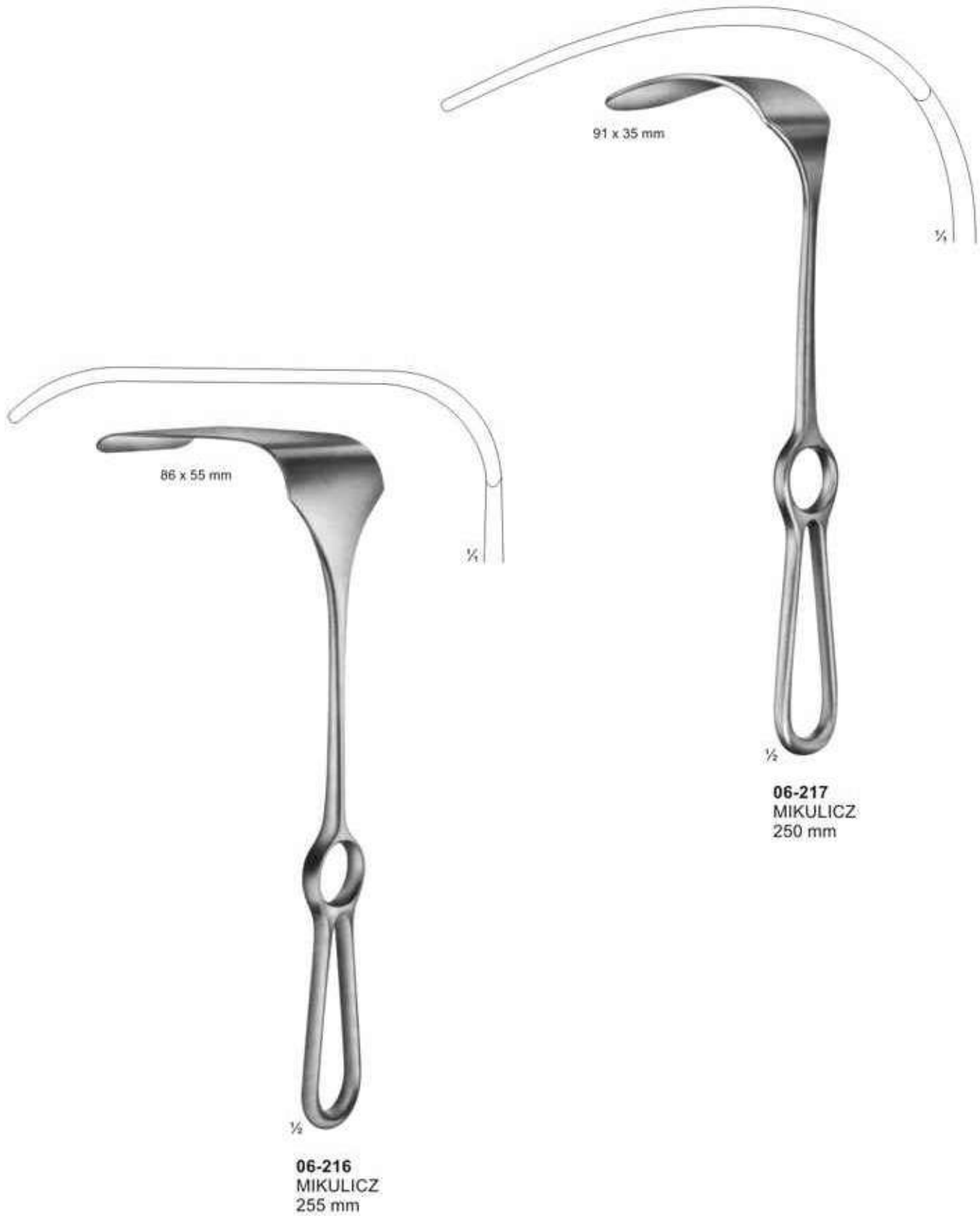

# Retractors, Abdominal Retractors



- 06-229 Fig.1 32 x 40 mm
- 06-230 Fig.2 34 x 50 mm
- 06-231 Fig.3 41 x 60 mm
- 06-232 Fig.4 46 x 75 mm
- 06-233 Fig.5 64 x 85 mm

**06-218 - 06-228**  
DOYEN  
240 mm

**06-229 - 06-233**  
FRITSCH  
240 mm

**06-234**  
DOYEN  
250 mm

	width of blades	35 mm, 45 mm, 60 mm
length of blades		
62 mm	06-218, 06-222, 06-226	
92 mm	06-219, 06-223, 06-227	
122 mm	06-220, 06-224, 06-228	
160 mm	06-221, 06-225	

Abdominal- and Intestinal Spatulas  
Bauch- und Darmspatel



06-235  
LERICHE  
255 mm

06-236  
KUMMEL  
Mealieable  
285 mm

06-237  
MIKULICZ  
29 mm  
250 mm

06-238 - 06-239  
KADER  
06-238 30 mm  
06-239 40 mm  
270 mm

## Self-Retaining Retractors



**06-240**  
WEITLANER  
sharp  
130 mm

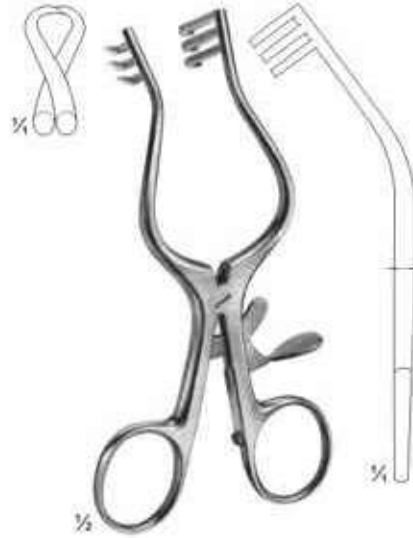

**06-241**  
WULLSTEIN  
sharp  
130 mm

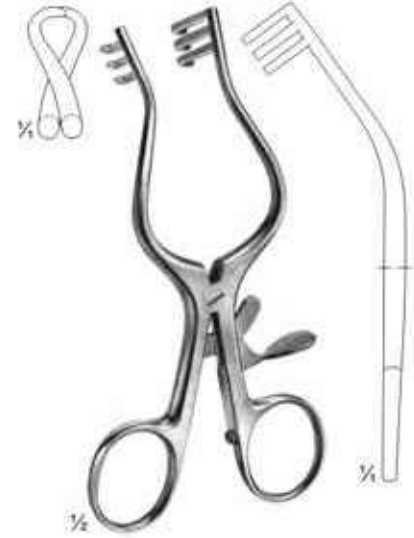

**06-242**  
WULLSTEIN  
blunt  
130 mm



**06-243**  
WEITLANER  
sharp  
165 mm



**06-244**  
PLESTER  
blunt  
110 mm



**06-245**  
PERKINS  
130 mm

## Special Retractors



**06-246**  
JOLL ( FRIEDMAN )  
Thyroid- and vaginal retractor  
155 mm



**06-247**  
JACKSON BURROWS  
Retractor, blunt  
185 mm



**06-248**  
GELPI  
Vaginal retractor  
135 mm



**06-249**  
GELPI  
Skin- and vaginal retractor  
175 mm

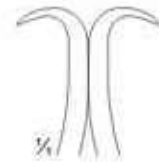

**06-250**  
DE BAKEY  
Femur retractor  
145 mm

# Lamina Spreaders



**06-251**  
CLOWARD  
155 mm



**06-252**  
CLOWARD  
135 mm



**06-253**  
INGE  
170 mm

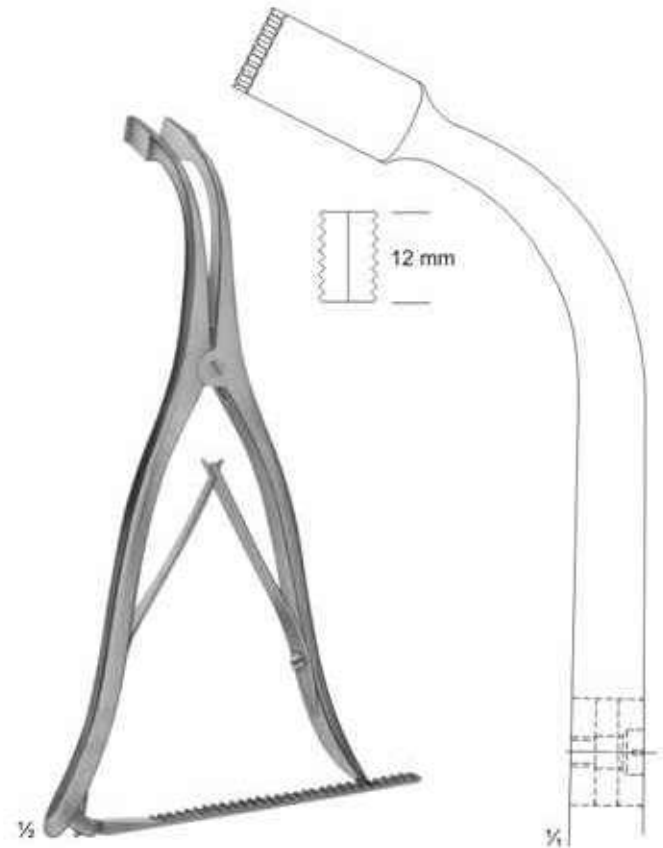

**06-254**  
INGE  
275 mm

## Abdominal Retractors



**06-255**  
GOSSET  
Blades: 38 mm deep

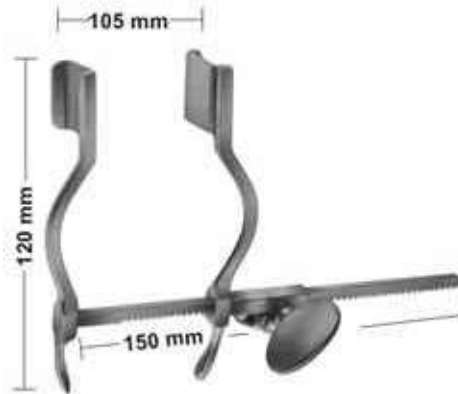

**06-256**  
HERTZLER  
Blades 20 X 25 mm

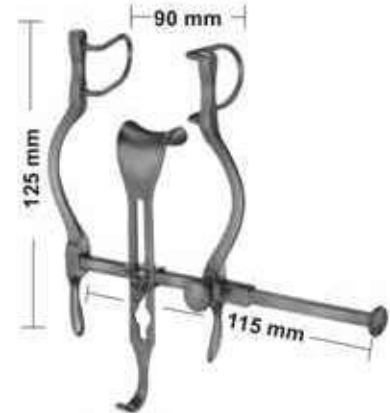

**06-257**  
BALFOUR-BABY  
Lateral blades 27 mm deep  
Center blade 21x24 mm

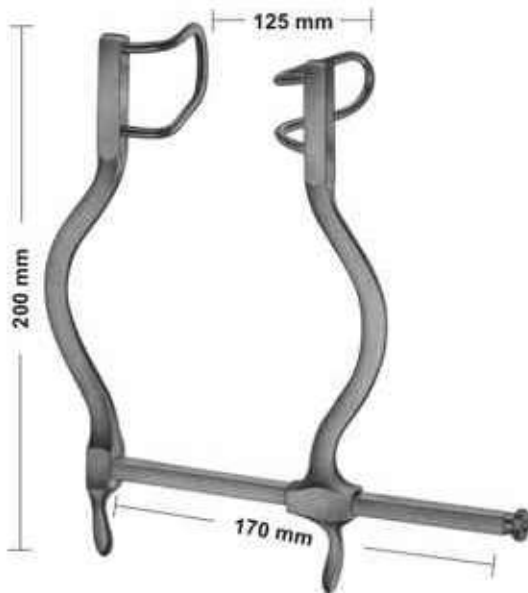

**06-258**  
GOSSET  
Blades: 55 mm deep

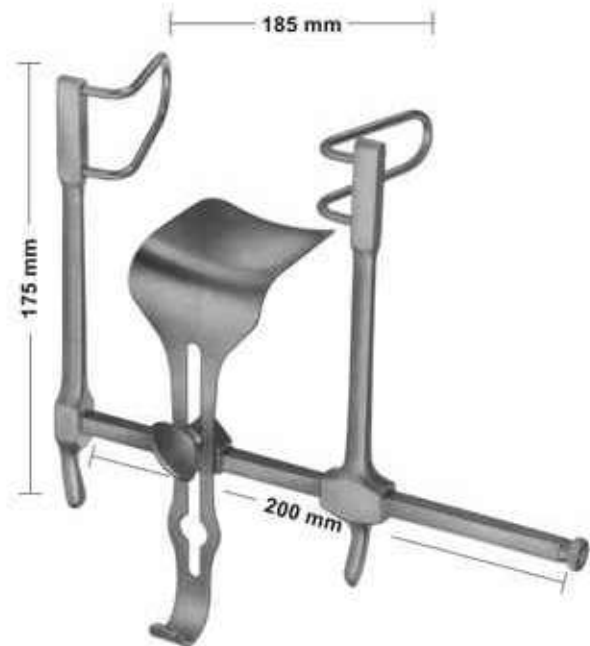

**06-259**  
GOSSET  
Lateral blades 58 mm deep  
Center blade 59 x 57 mm



# Abdominal Retractors

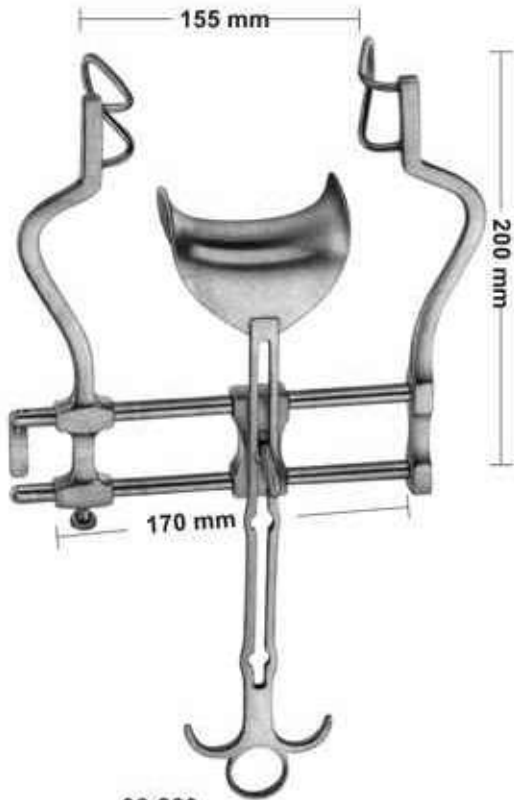

**06-260**  
BALFOUR  
Lateral blades 60 mm deep  
Center blade 47 x 80 mm

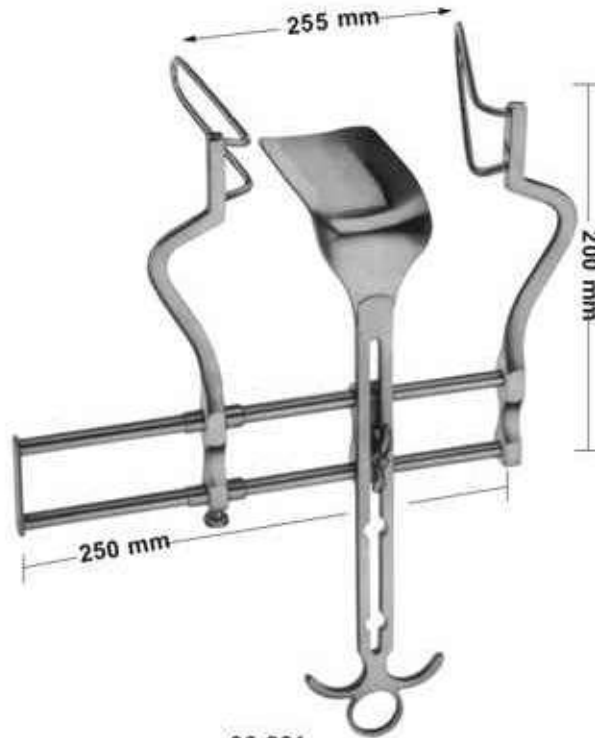

**06-261**  
BALFOUR  
Lateral blades 105 mm deep  
Center blade 107x 59 mm



**06-262**  
Center blade only  
54x80 mm

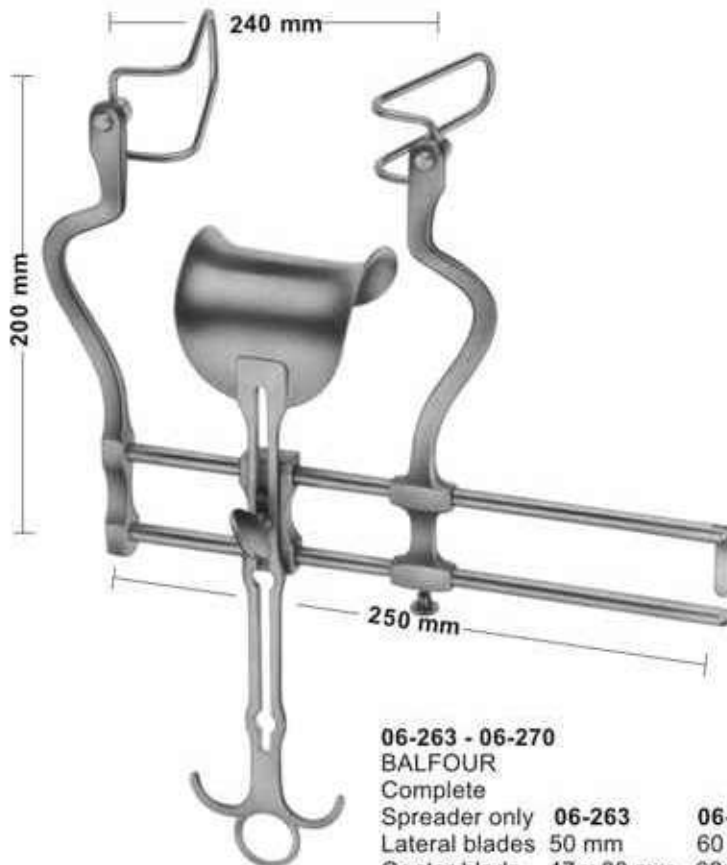

**06-263 - 06-270**  
BALFOUR  
Complete

Spreader only	06-263	06-264	06-265	06-266
Lateral blades	50 mm	60 mm	75 mm	90 mm
Center blade	47 x 80 mm	62x76 mm	80x80 mm	80x80 mm



Lateral blades  
**06-267** 50 mm deep  
**06-268** 60 mm deep  
**06-269** 75 mm deep  
**06-270** 90 mm deep  
 Sales Unit of blades: PR = pair

# Organ-, Tissue and Intestinal Grasping Forceps

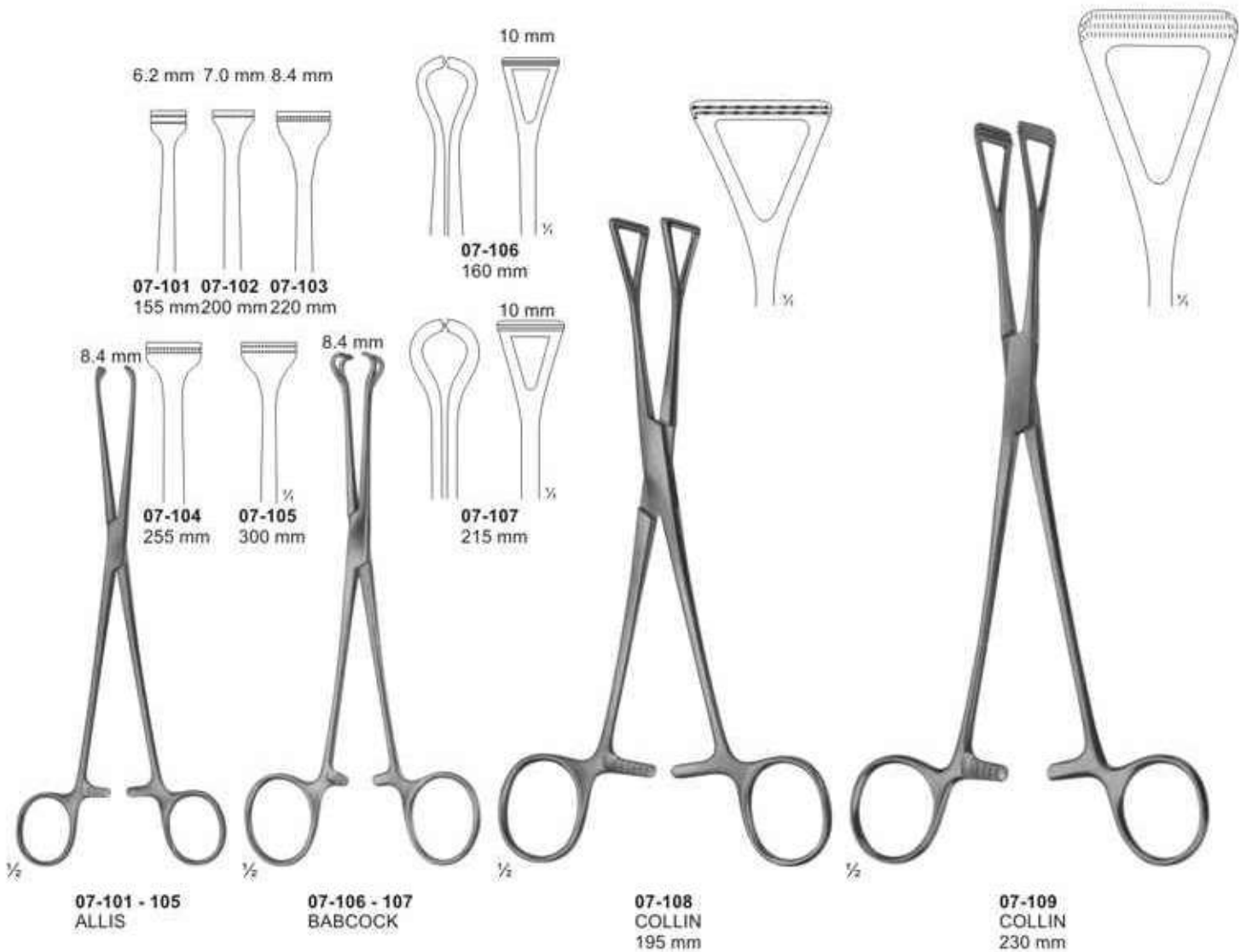

# Intestinal Clamps, soft elastic

## ATRAUMATA

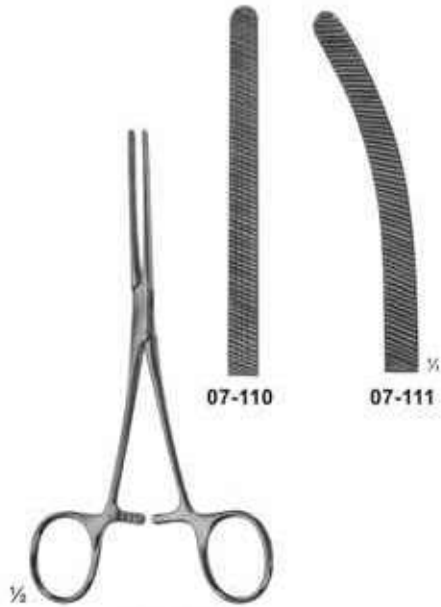

07-110 - 111  
DOYEN  
elastic  
165 mm

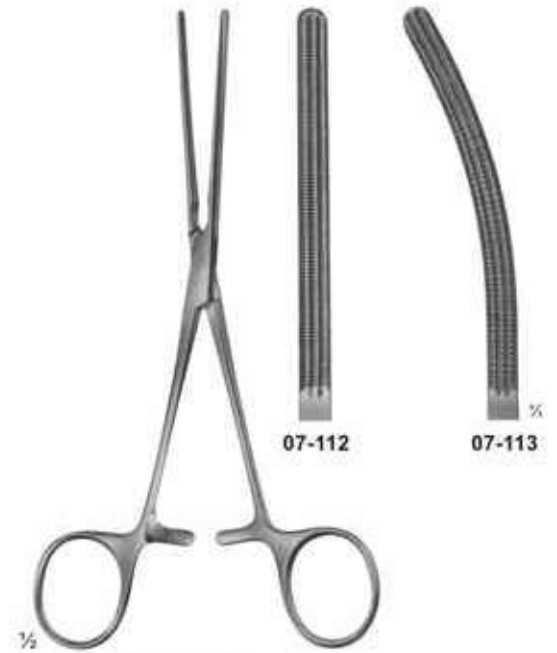

07-112 - 113  
DOYEN  
with elastic blades  
170 mm

## ATRAUMATA

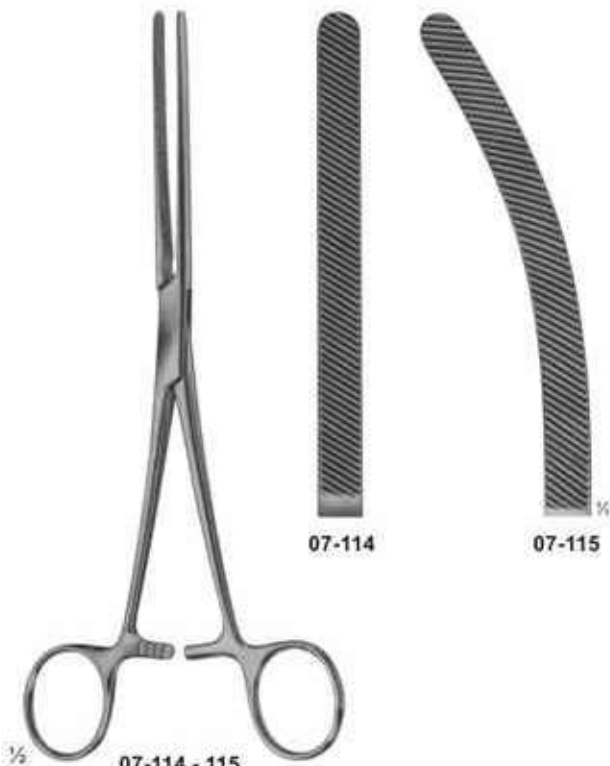

07-114 - 115  
HARTMANN  
with elastic blades  
200 mm



07-116 - 117  
HARTMANN  
with elastic blades  
200 mm

## Intestinal and Pylorus Clamps



**07-118**  
PAYR  
Intestinal clamp  
light pattern,  
for children  
180 mm

**07-119**  
PAYR  
200 mm

**07-120**  
PAYR  
275 mm

**07-121**  
PAYR  
Pylorus clamp  
315 mm

**ATRAUMATA**  
**Sigmoid Anastomosis Forceps**

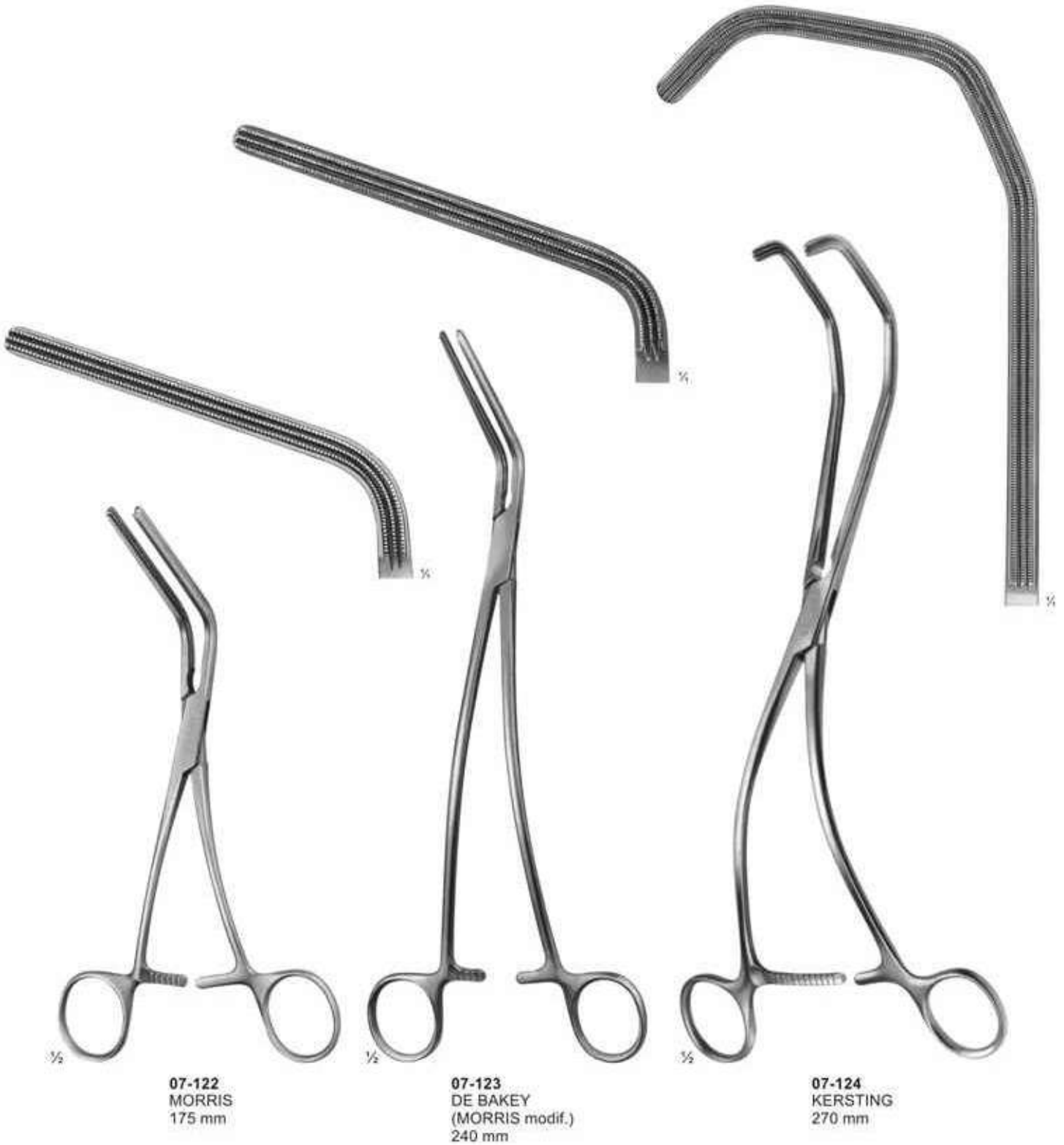

# Nasal Specula



**08-101**  
Martin  
13 cm / 5 1/8"



**08-102**  
SIMS  
160 mm

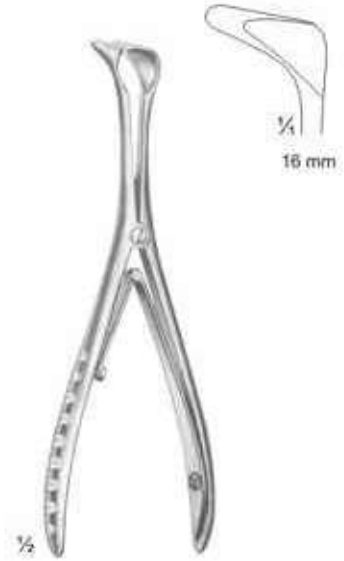

**08-103**  
Tieck-Halle  
13 cm / 5 1/8"



**08-104**  
Killian

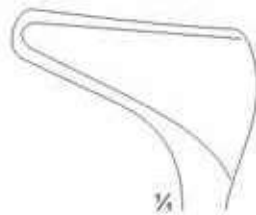

**Fig. 1**  
14 cm 5 4/8"  
35 mm

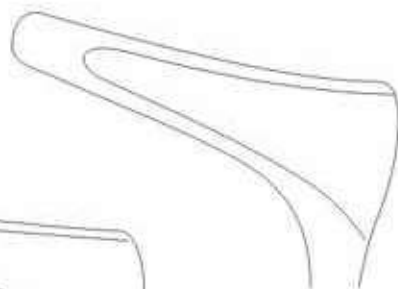

**Fig. 2**  
14,5 cm / 5 4/8"  
50 mm

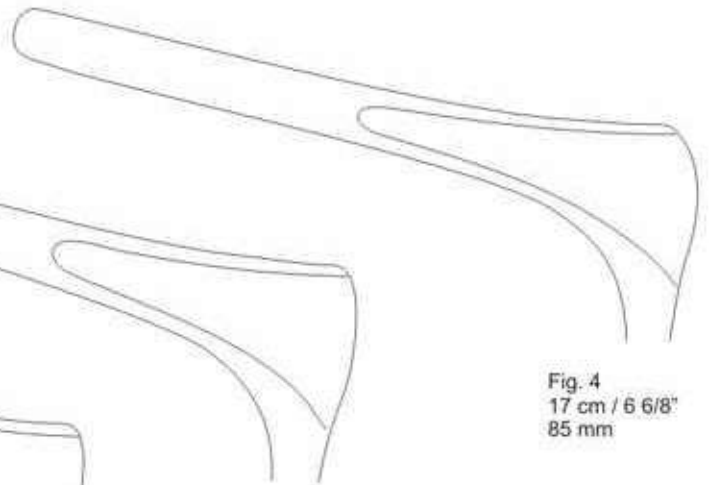

**Fig. 3**  
16 cm / 6 2/8"  
75 mm

**Fig. 4**  
17 cm / 6 6/8"  
85 mm

# Nasal Specula



**08-105**  
Cottle

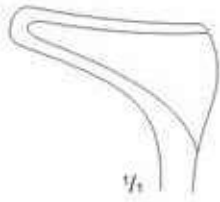

Fig. 1  
13,5 cm / 5 3/8"  
35 mm

1/2

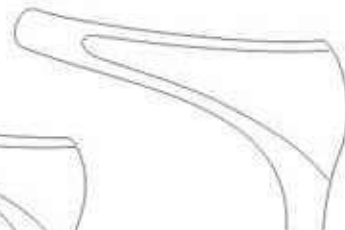

Fig. 2  
14 cm / 5 4/8"  
50 mm

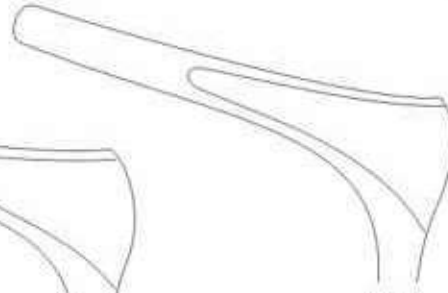

Fig. 3  
16 cm / 6 2/8"  
75 mm

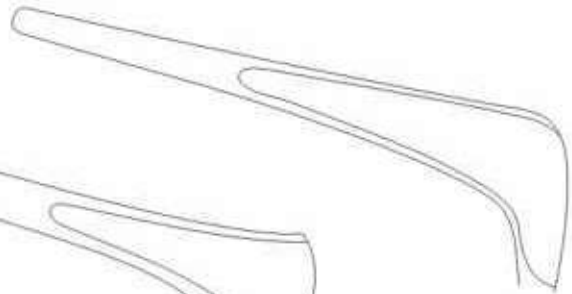

Fig. 4  
16 cm / 6 2/8"  
85 mm



**08-106**  
Goldsmith (Thudichum)  
6,5 cm / 2 4/8"

1/2



Fig. 1  
21,0 x 9,5 mm



Fig. 2  
21,0 x 10,5 mm



Fig. 3  
21,0 x 11,5 mm



**08-107**  
Mod. Wien 2  
13,5 cm / 5 7/8"

1/2

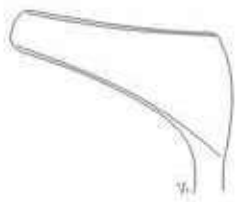

Fig. 1  
30 mm

1/2



**08-108**  
Hartmann-Halle  
16 cm / 6 7/8"



Fig. 1  
27 mm



Fig. 2  
31 mm

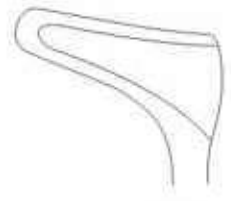

Fig. 3  
35 mm

# Anuscopy-Sphincteroscopes



**08-109**  
**IVES-FANSLER**  
 Anuscopy  
 145 mm  
 Ø24mm



**08-110**  
**KELLY**  
 Sphincteroscope  
 160 mm  
 Ø21mm



**08-111**  
**KELLY**  
 Sphincteroscope  
 160 mm  
 Ø27mm

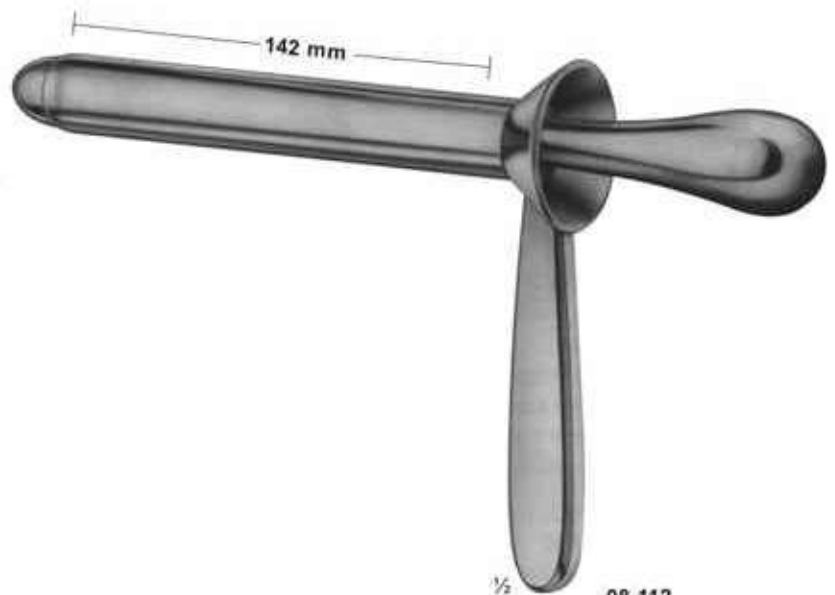

**08-112**  
**KELLY**  
 Proctoscope  
 140 mm  
 Ø22mm



# Haemorrhoidal Forceps

## ATRAUMATA

### Pressure Clamp

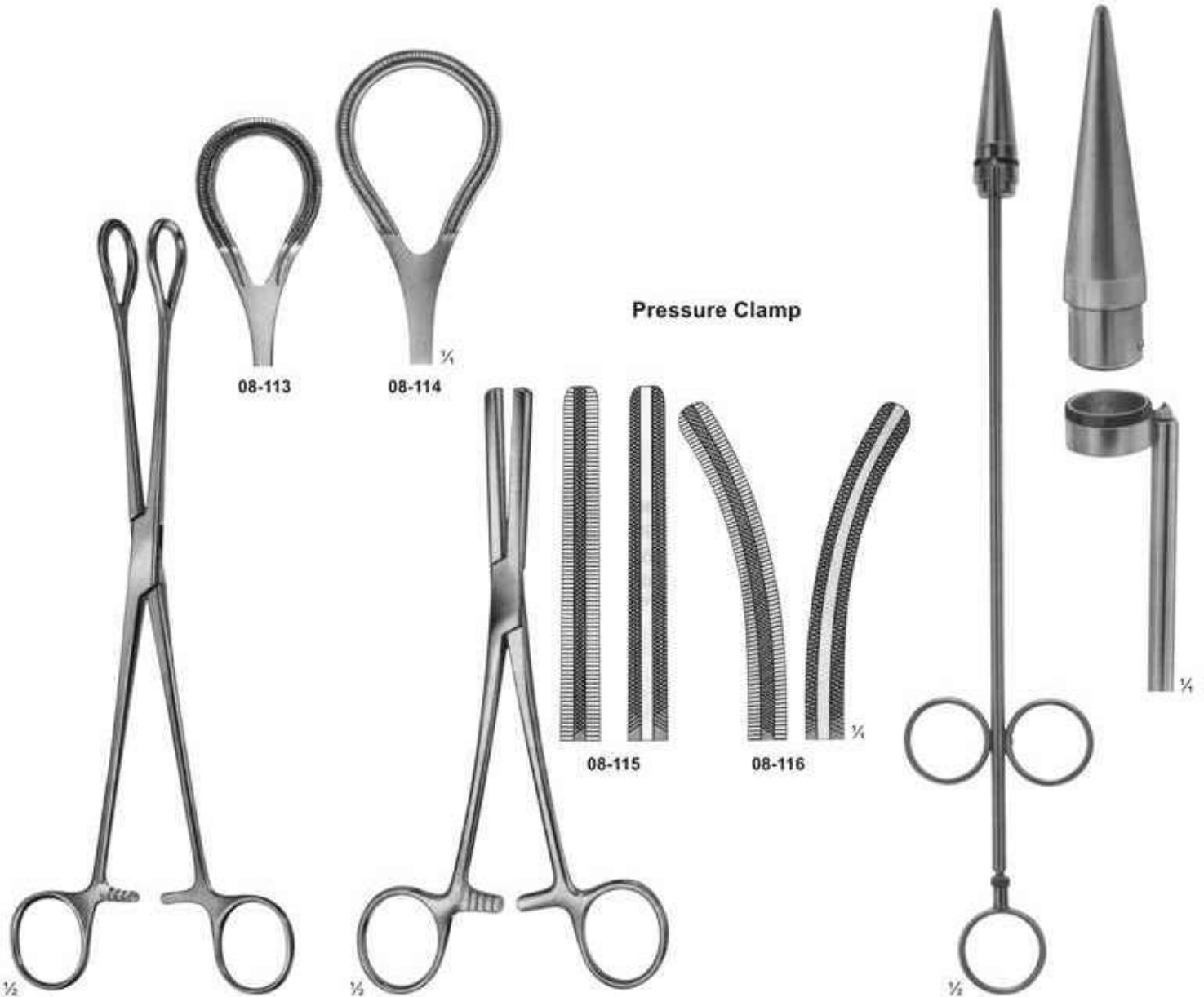

08-113 - 08-114  
250 mm  
08-114  
270 mm

08-115 - 08-116  
FERGUSSON  
200 mm

08-117  
RUDD  
Haemorrhoidal ligator  
with loading  
attachment and 100  
ligature rubber rings  
315 mm

## Gall Duct Forceps



**08-118**  
LOWER  
180 mm



**08-119**  
LAHEY ( SWEET )  
190 mm



**08-120**  
LAHEY  
220 mm



**08-121**  
DESJARDINS  
Gall duct-and cystic forceps  
210 mm



**08-122**  
NISSEN  
Gall duct-and cystic forceps  
215 mm

## Gall Duct Dilators and Gall Stone Scoops

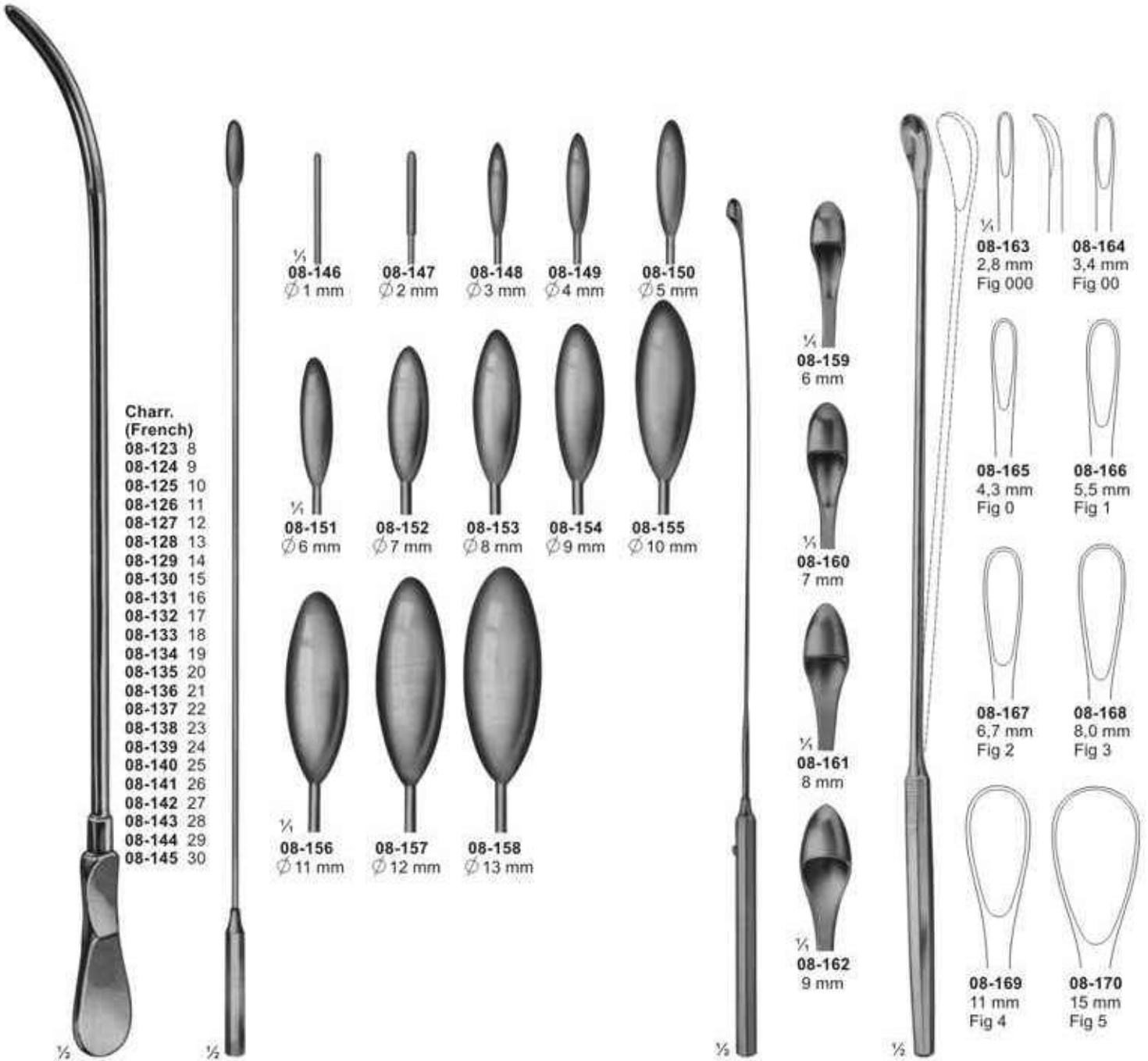

**Charr.**  
**(French)**  
 08-123 8  
 08-124 9  
 08-125 10  
 08-126 11  
 08-127 12  
 08-128 13  
 08-129 14  
 08-130 15  
 08-131 16  
 08-132 17  
 08-133 18  
 08-134 19  
 08-135 20  
 08-136 21  
 08-137 22  
 08-138 23  
 08-139 24  
 08-140 25  
 08-141 26  
 08-142 27  
 08-143 28  
 08-144 29  
 08-145 30

1/4  
**08-146**  
 Ø 1 mm  
**08-147**  
 Ø 2 mm  
**08-148**  
 Ø 3 mm  
**08-149**  
 Ø 4 mm  
**08-150**  
 Ø 5 mm  
 1/4  
**08-151**  
 Ø 6 mm  
**08-152**  
 Ø 7 mm  
**08-153**  
 Ø 8 mm  
**08-154**  
 Ø 9 mm  
**08-155**  
 Ø 10 mm  
 1/4  
**08-156**  
 Ø 11 mm  
**08-157**  
 Ø 12 mm  
**08-158**  
 Ø 13 mm

1/4  
**08-159**  
 6 mm  
 1/4  
**08-160**  
 7 mm  
 1/4  
**08-161**  
 8 mm  
 1/4  
**08-162**  
 9 mm  
 1/4  
**08-163**  
 2,8 mm  
 Fig 000  
**08-164**  
 3,4 mm  
 Fig 00  
**08-165**  
 4,3 mm  
 Fig 0  
**08-166**  
 5,5 mm  
 Fig 1  
**08-167**  
 6,7 mm  
 Fig 2  
**08-168**  
 8,0 mm  
 Fig 3  
**08-169**  
 11 mm  
 Fig 4  
**08-170**  
 15 mm  
 Fig 5

**08-123 - 08-145**  
**DITTEL**  
 Metall bougies and  
 dilating sounds, stiff  
 345 mm

**08-146 - 08-158**  
**BAKES**  
 Common bile duct  
 dilators, malleable  
**08-146 - 08-150** 315 mm  
**08-151 - 08-158** 320 mm

**08-159 - 08-162**  
**DESJARDINS**  
 Probe and catch  
 with flexible shaft  
 300 mm

**08-163 - 08-170**  
**LUER-KOERTE modif**  
 with malleable shaft  
 310 mm

# Gall Stone Forceps

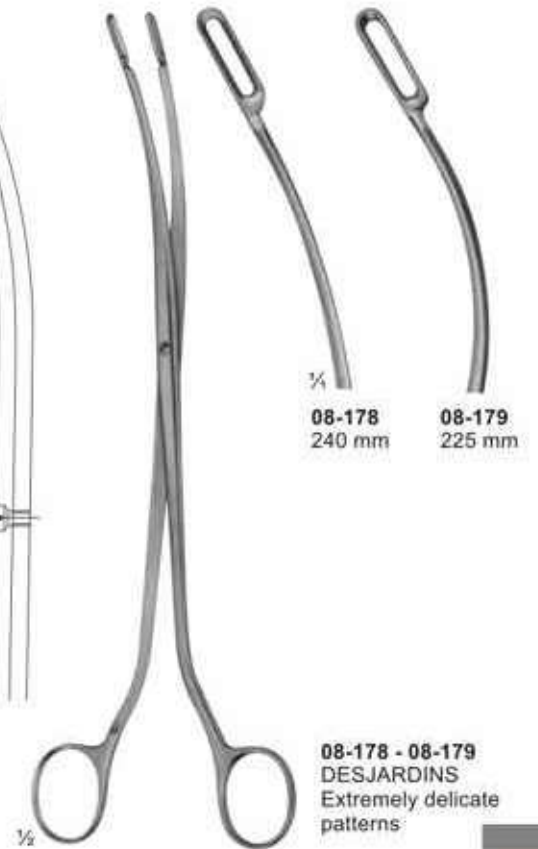
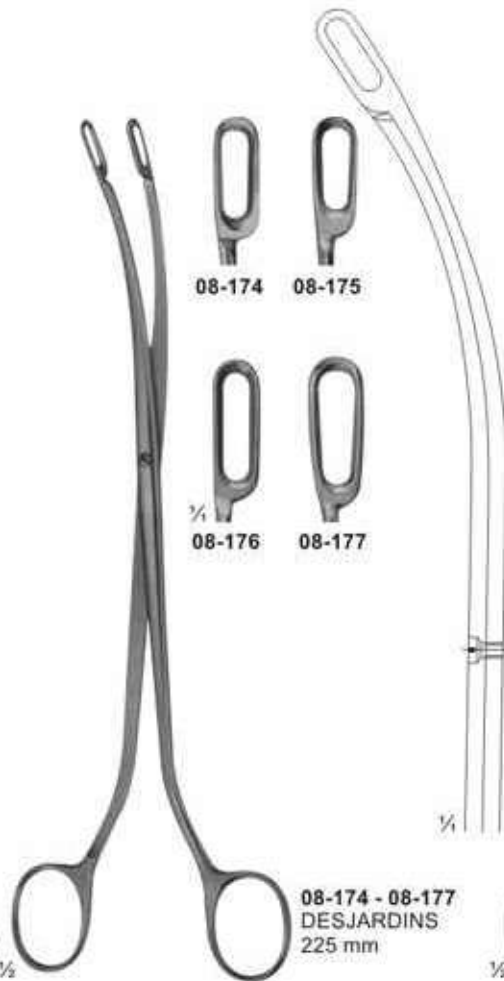
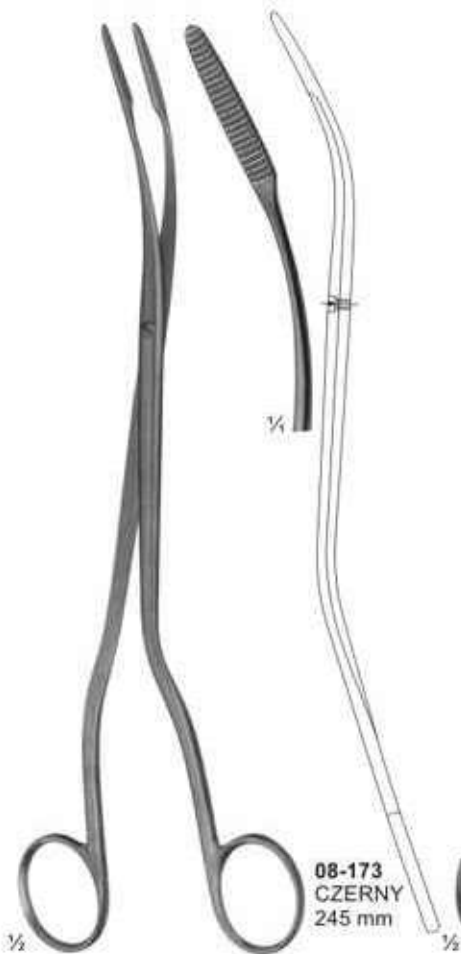
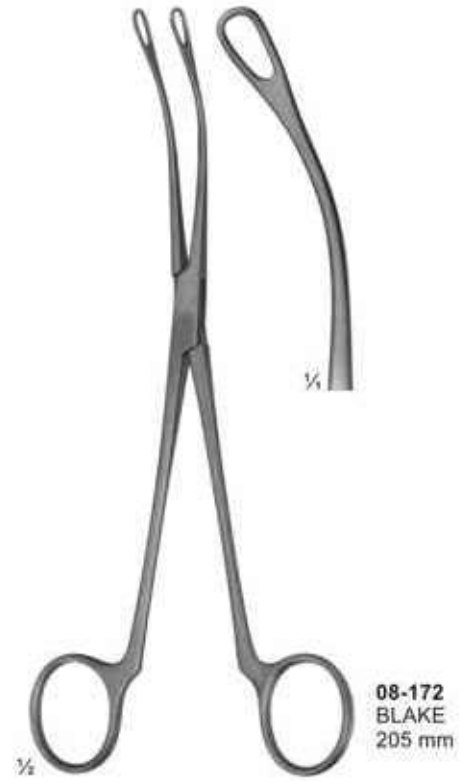

# Kidney Clamps

## ATRAUMATA

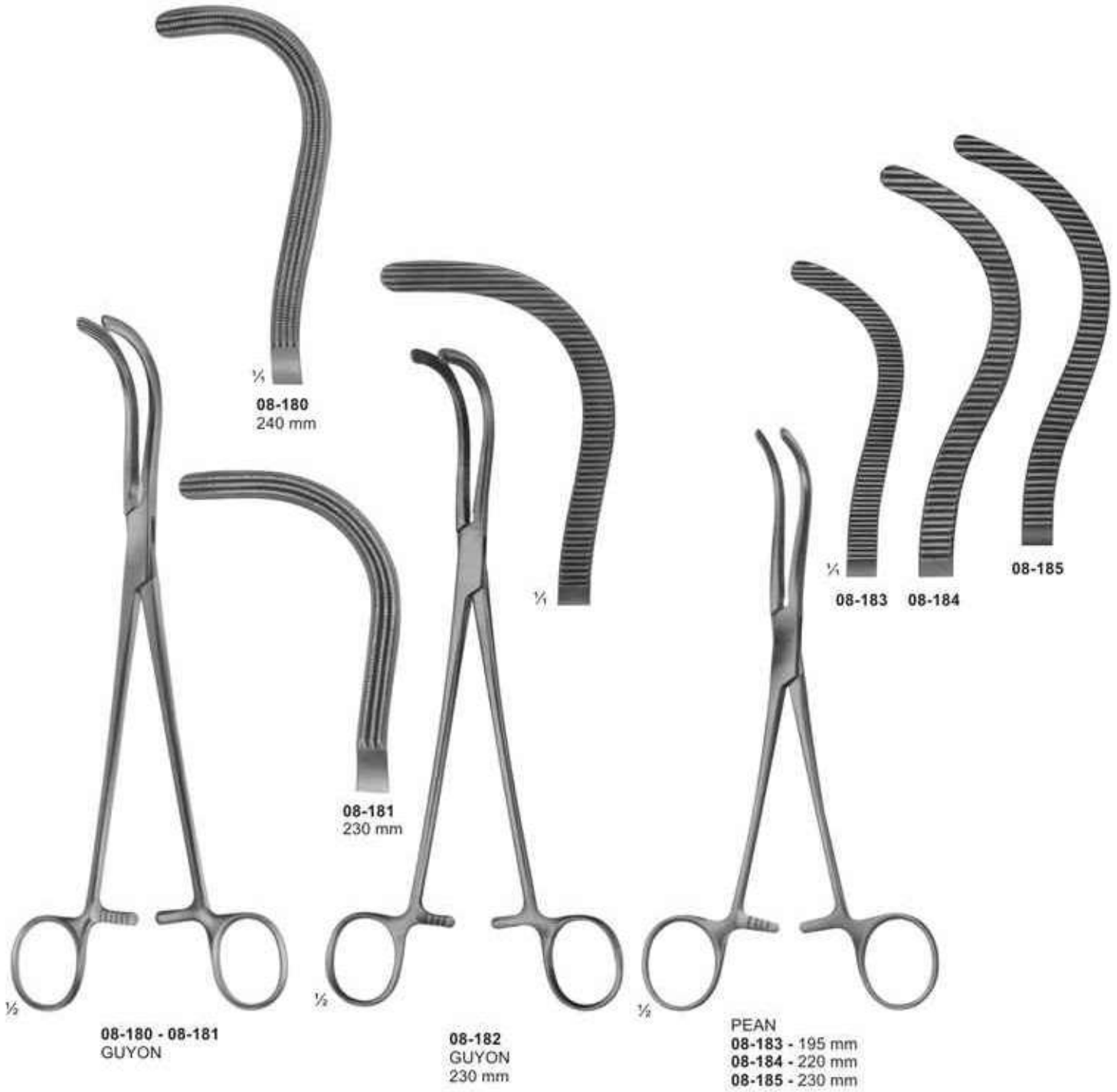

# Kidney Stone Forceps



08-186



08-187



08-188



1/4  
08-189



08-190



08-191



1/4  
08-192



1/2

08-186 - 08-189  
RANDALL  
225 mm



1/2

08-190 - 08-192  
RANDALL  
190 mm

## Bladder Retractors

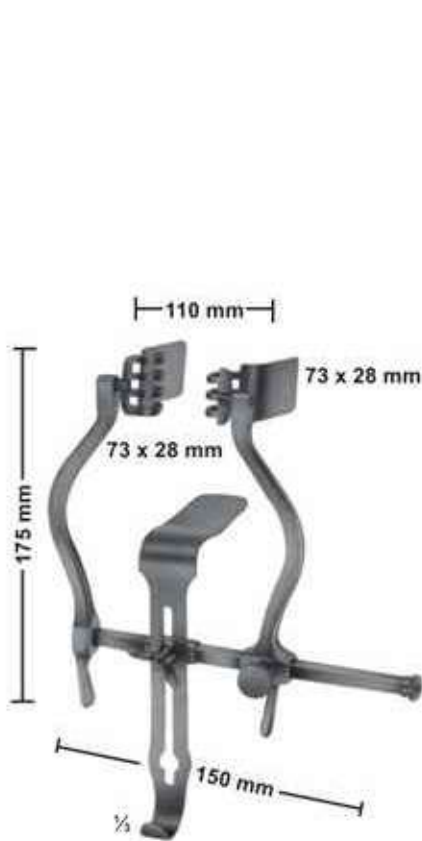

**09-101**  
**JUDD-MASSON**  
 Bladder-and suprapubic  
 retractor



**09-102**  
**MILLIN**  
 Center bladder for  
 retro pubic prostatectomy



**09-103**  
**MILLIN**  
 Bladder retractor, complete  
 105X45 mm



**09-104**  
**LEGUEU**  
 Bladder retractor  
 Center blade  
 80 x 31 mm



**09-105**  
**KOCHER**  
 Bladder spatula  
 235 mm

# Trocars



**09-106**  
KLIMA ROSEGGER  
35 X 1,8 mm  
Sternal puncture needle



**09-107**  
Universal trocar  
with 4 tips



NELSON



**09-108 - 112**  
Inside diam. Outside diam  
**09-108** 2,2 mm 3,0 mm  
**09-109** 3,0 mm 4,0 mm  
**09-110** 4,0 mm 5,0 mm  
**09-111** 5,0 mm 6,0 mm  
**09-112** 5,5 mm 6,5 mm  
 for hydrocele and abdominal puncture

**09-113 - 116**  
Inside dime. Outside dime  
**09-113** 2,2 mm 3,0 mm  
**09-114** 3,0 mm 4,0 mm  
**09-115** 4,0 mm 5,0 mm  
**09-116** 5,0 mm 6,0 mm  
 for abdominal puncture,  
 with stop-cock and lateral  
 drain



**09-117 - 118**  
Inside diam. Outside diam  
**09-117** 6,5 mm 8,0 mm  
**09-118** 9,0 mm 10,0 mm  
 Empyema trocar  
 BUELEU



**09-119 - 122**  
Inside diam. Outside diam  
**09-119** 3,0 mm 4,0 mm  
**09-120** 3,6 mm 4,6 mm  
**09-121** 4,3 mm 5,3 mm  
**09-122** 5,0 mm 6,0 mm  
 Gall bladder trocars. OCHSNER



**09-123**  
PIERCE  
Antrum trocar  
 $\phi$  4,0 mm



**09-124**  
COAKLEY  
Antrum trocar  
3,0 mm



## Vaginal Specula



**10-101**  
 COLLIN  
 for children  
 53 x 10 mm

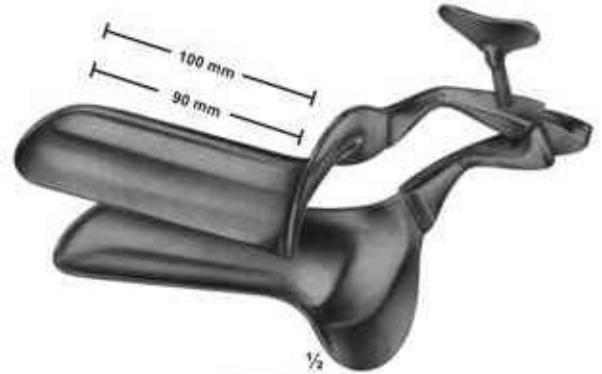

**10-102 - 105**  
 COLLIN  

<b>10-102</b>	100/90mm	28 mm
<b>10-103</b>	100/90mm	32 mm
<b>10-104</b>	105/95mm	35 mm
<b>10-105</b>	115/105mm	40 mm

 Total length/working length width



**10-106**  
 COLLIN  
 for virgins  
 95/85 x 18 mm



**10-107**  
 CUSCO  
 for virgins  
 75 x 17 mm



**10-108**  
 CUSCO  
 for virgins  
 75 x 17 mm

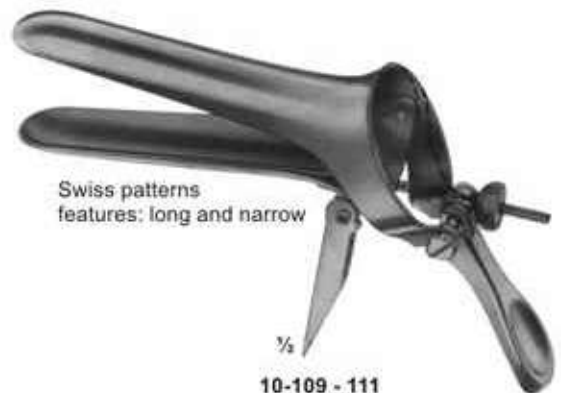

Swiss patterns  
 features: long and narrow  
**10-109 - 111**  
 CUSCO  

<b>10-109</b>	92X23-25 mm
<b>10-110</b>	100x25-27 mm
<b>10-111</b>	110x27-30 mm

## Vaginal Specula- Sets, upper and lower blades



10-112 - 114  
GRAVE  
10-112 75X20 mm  
10-113 95X30 mm  
10-114 105X33 mm

1/2



10-115 - 116  
PEDERSON  
10-115 100X22 mm  
10-116 120X25 mm

1/2



10-117 - 118  
BRIESKY  
10-117 72X25 mm / 77X30 mm 140 mm  
10-118 75X30 mm / 92X38 mm 170 mm

1/2



1/2

10-119  
SIMS  
70 X 26 mm / 75 X 30 mm  
75 X 30 mm / 80 X 35 mm  
80 X 36 mm / 90 X 40 mm  
175 mm



1/2

10-120 - 122  
SEIDL  
10-120 80X8 mm  
10-121 80X10 mm  
10-122 90X14 mm  
For children and infants  
170 mm



1/2

10-123  
KRISTELLER  
70X15 mm, ( 170 mm )  
For children



1/2

10-124 - 10-126  
KRISTELLER  
10-124 70X27 mm  
10-125 75X30 mm  
10-126 90X36 mm  
175 mm

## Vaginal Specula- upper and lower blades



10-127 - 131  
KRISTELLER  
10-127 110X18 mm  
10-128 110X20 mm  
10-129 110X27 mm  
10-130 110X30 mm  
10-131 110X36 mm  
220 mm

10-132 - 10-135  
KRISTELLER  
Upper blades

10-136 - 10-139  
KRISTELLER  
Lower blades

# Vaginal Specula



## Vaginal Retractors



1/2  
10-154  
JOLL (FRIEDMAN)  
155 mm



1/2  
10-155  
RICHTER  
170 mm



1/2  
10-156  
GELPI  
135 mm



1/2  
10-157  
GELPI  
175 mm

## Uterine Dilators



11-101 - 143  
HEGAR  
with very conical point  
185 mm

11-101	1	mm	11-123	23	mm
11-102	2	mm	11-124	24	mm
11-103	3	mm	11-125	25	mm
11-104	4	mm	11-126	26	mm
11-105	5	mm	11-127	1	1/2mm
11-106	6	mm	11-128	2	1/2mm
11-107	7	mm	11-129	3	1/2mm
11-108	8	mm	11-130	4	1/2mm
11-109	9	mm	11-131	5	1/2mm
11-110	10	mm	11-132	6	1/2mm
11-111	11	mm	11-133	7	1/2mm
11-112	12	mm	11-134	8	1/2mm
11-113	13	mm	11-135	9	1/2mm
11-114	14	mm	11-136	10	1/2mm
11-115	15	mm	11-137	11	1/2mm
11-116	16	mm	11-138	12	1/2mm
11-117	17	mm	11-139	13	1/2mm
11-118	18	mm	11-140	14	1/2mm
11-119	19	mm	11-141	15	1/2mm
11-120	20	mm	11-142	16	1/2mm
11-121	21	mm	11-143	17	1/2mm
11-122	22	mm			



11-144 - 152  
HEGAR  
205 mm

11-144	1+2	mm
11-145	3+4	mm
11-146	5+6	mm
11-147	7+8	mm
11-148	9+10	mm
11-149	11+12	mm
11-150	13+14	mm
11-151	15+16	mm
11-152	17+18	mm



11-153  
HEGAR  
Uterine dilator set, in canvas  
roll with 8 dilators.

## Uterine Probes

5 mm



11-154  
MAYO  
malleable  
330 mm

4 mm



11-155  
SIMS  
malleable  
330 mm

3 mm



11-156  
MARTIN  
330 mm

4 mm



11-157  
SIMPSON  
malleable  
silver-plated  
290 mm



11-158  
BRAUN  
Uterine  
depressor  
270 mm

24 mm



11-159  
Cotton  
applicator  
270 mm

## Uterine Dressing Forceps



11-160  
PELKMANN  
260 mm



11-161  
PELKMANN  
260 mm



11-162  
BOZEMANN  
250 mm



11-163  
BOZEMANN  
255 mm

Jaws with longitudinal groove



## Polypus-and Ovum Forceps



11-164  
HEYWOOD-SMITH  
200 mm

11-165  
KELLY  
320 mm

11-166  
HEYWOOD-SMITH  
250 mm

11-167  
NOTO  
280 mm

# Ear Currettes



**12-101**  
Langenbeck  
13 cm / 5 1/8"

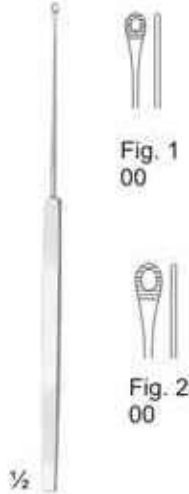

**12-102**  
Shapleigh  
15 cm / 5 1/8"

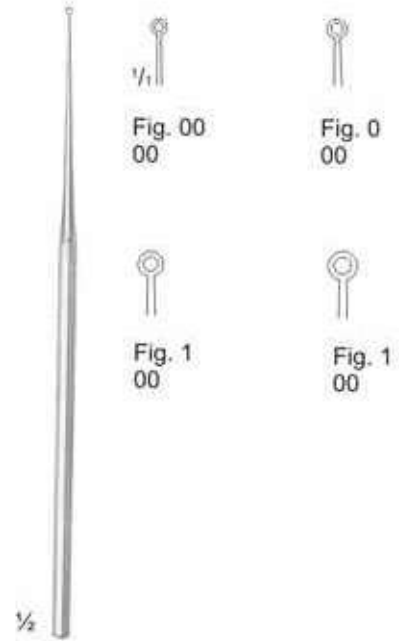

**12-103**  
Buck  
17cm / 6 6/8"



**12-104**  
Buck  
15 cm / 6 6/8"

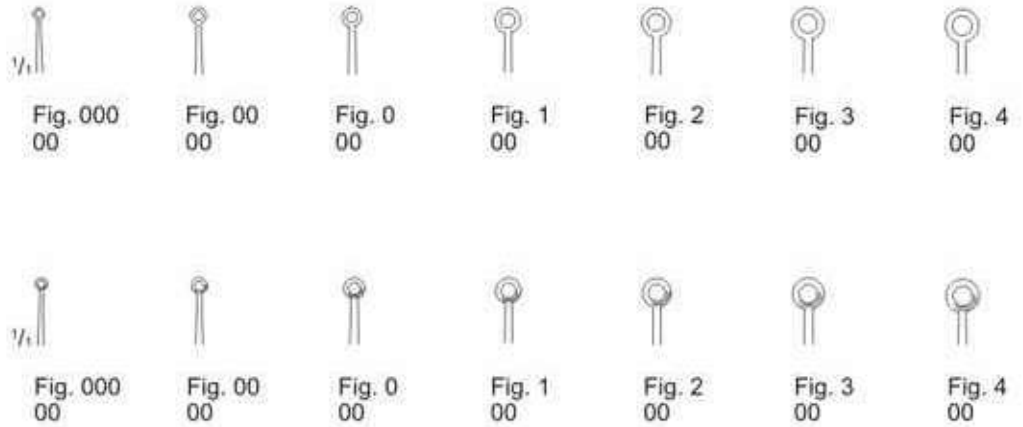

# Biopsy Currettes

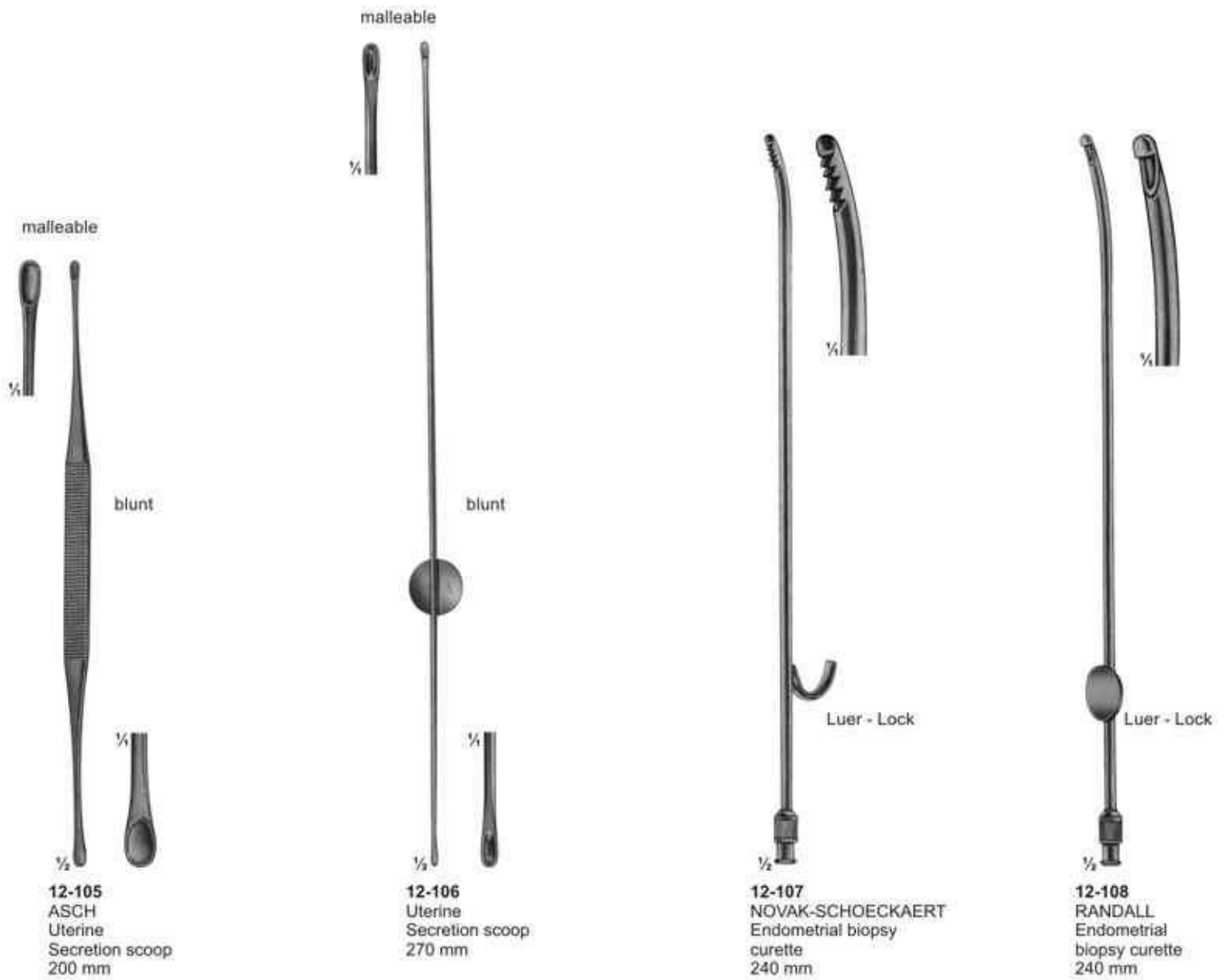

# Ear Polypus Forceps



**12-109**  
Hartmann-Wullstein  
shaft length  
85 mm

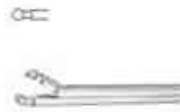

**12-110**  
Hartmann-Wullstein  
shaft length  
85 mm

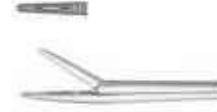

**12-111**  
Hartmann  
shaft length  
85 mm



**12-112**  
Hartmann  
shaft length  
85 mm

**12-113**  
14 cm / 5 4/8"  
shaft length  
140 mm



**12-109 - 12-119**



**12-114**  
Hartmann-Herzfeil  
2,0 mm  
shaft length  
85mm



**12-115**  
Hartmann  
3 mm  
shaft length  
85mm



**12-116**  
shaft length  
85mm



**12-117**  
Hartmann-Hoffmar  
2,0 mm  
85mm

**12-118**  
2,5 mm  
85 mm

**12-119**  
3,0 mm  
85 mm

## Biopsy forceps for rectum

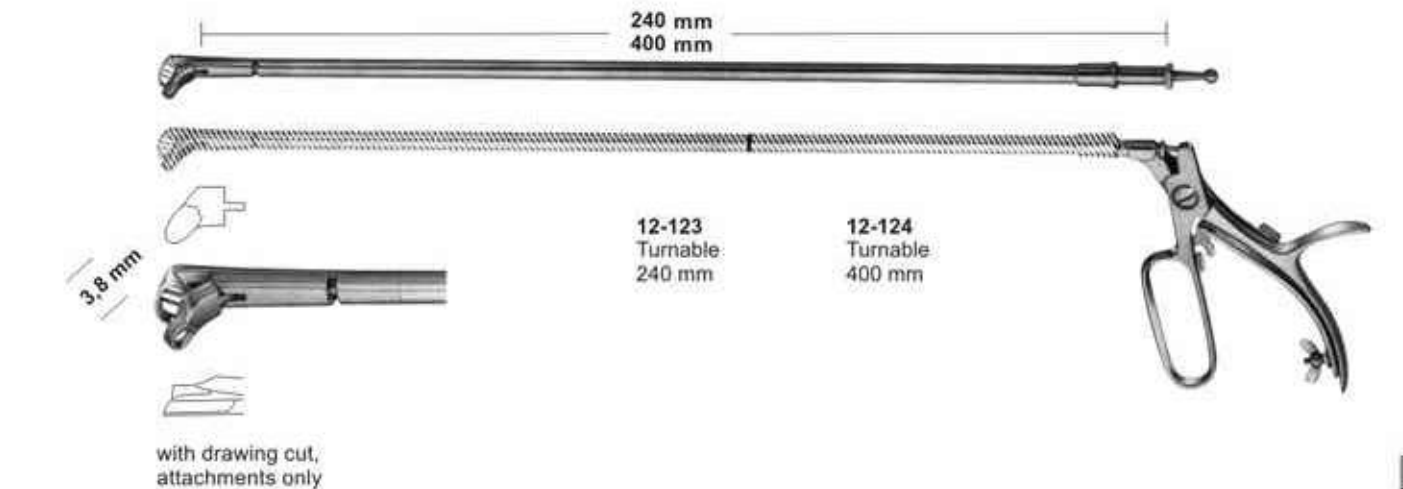
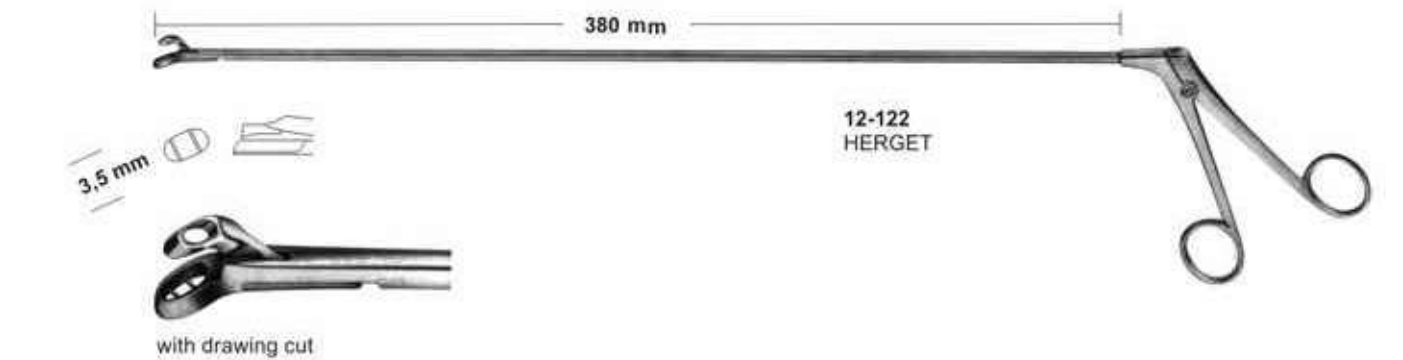
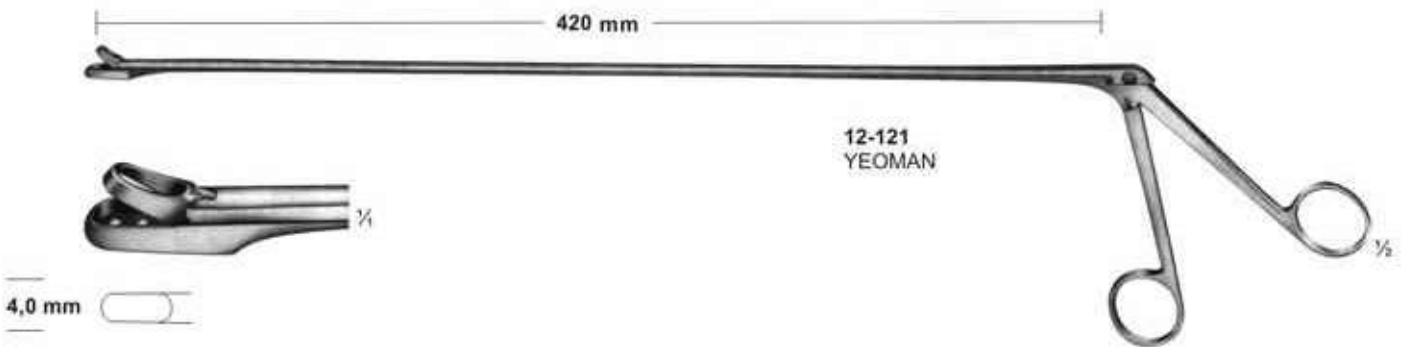
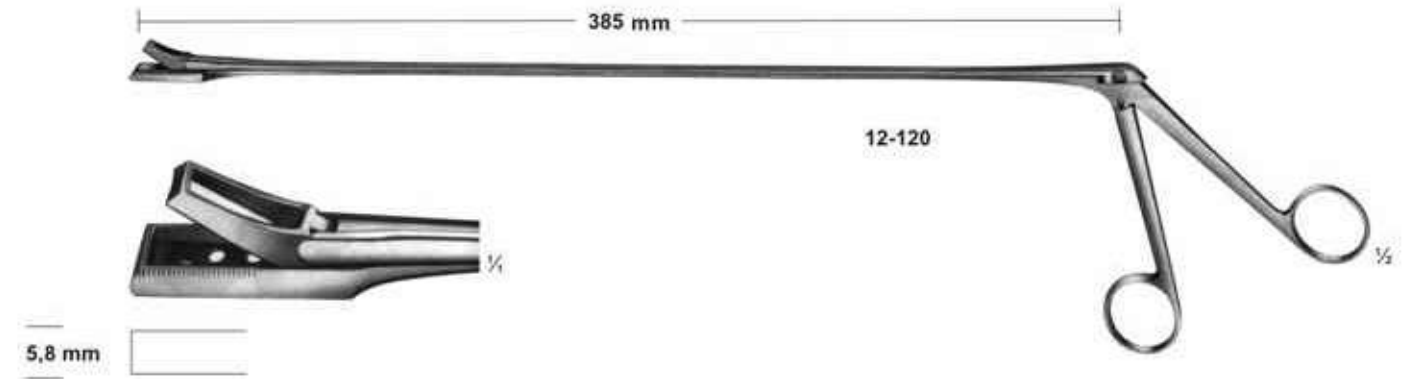

# Biopsy Forceps

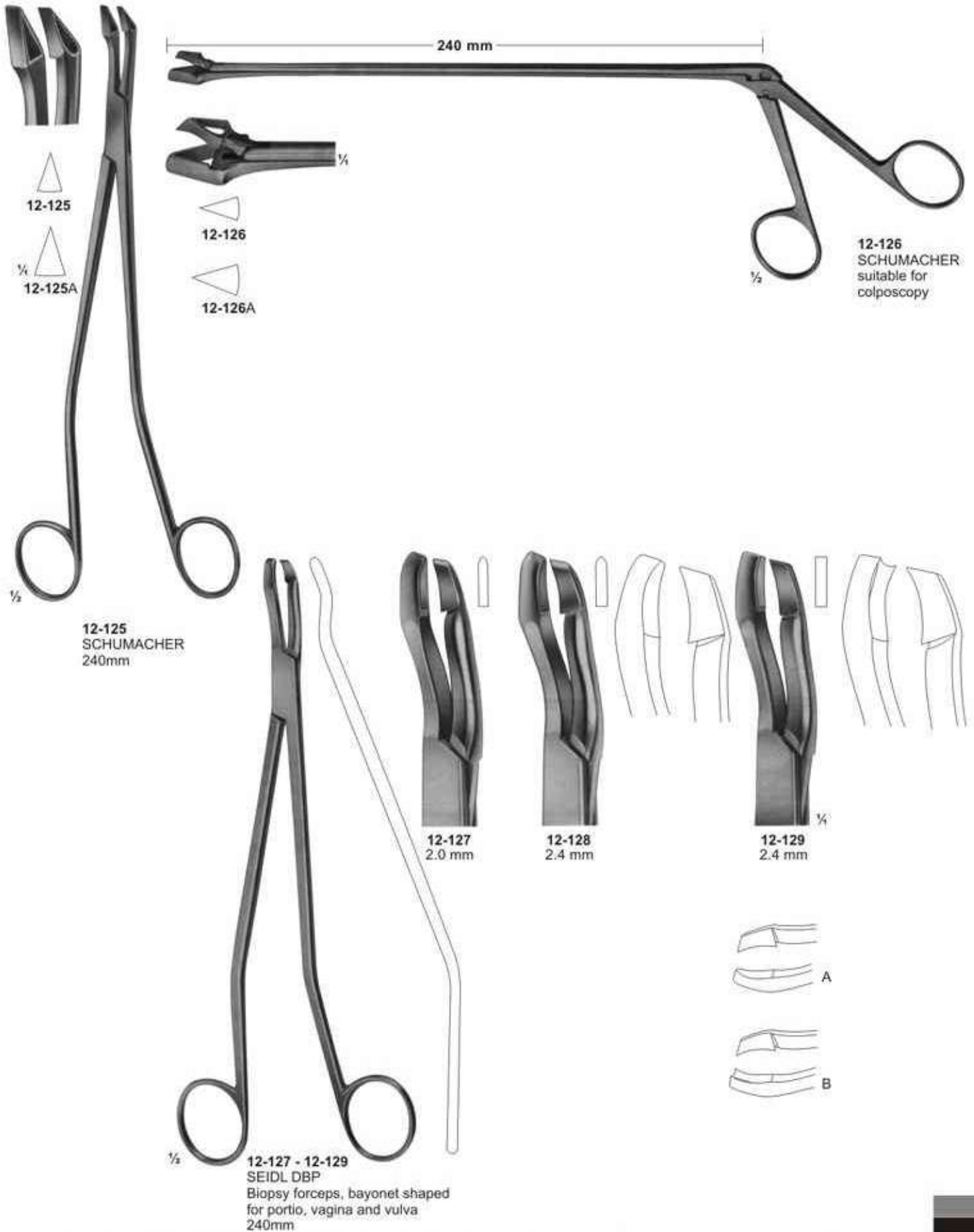

# Biopsy Forceps

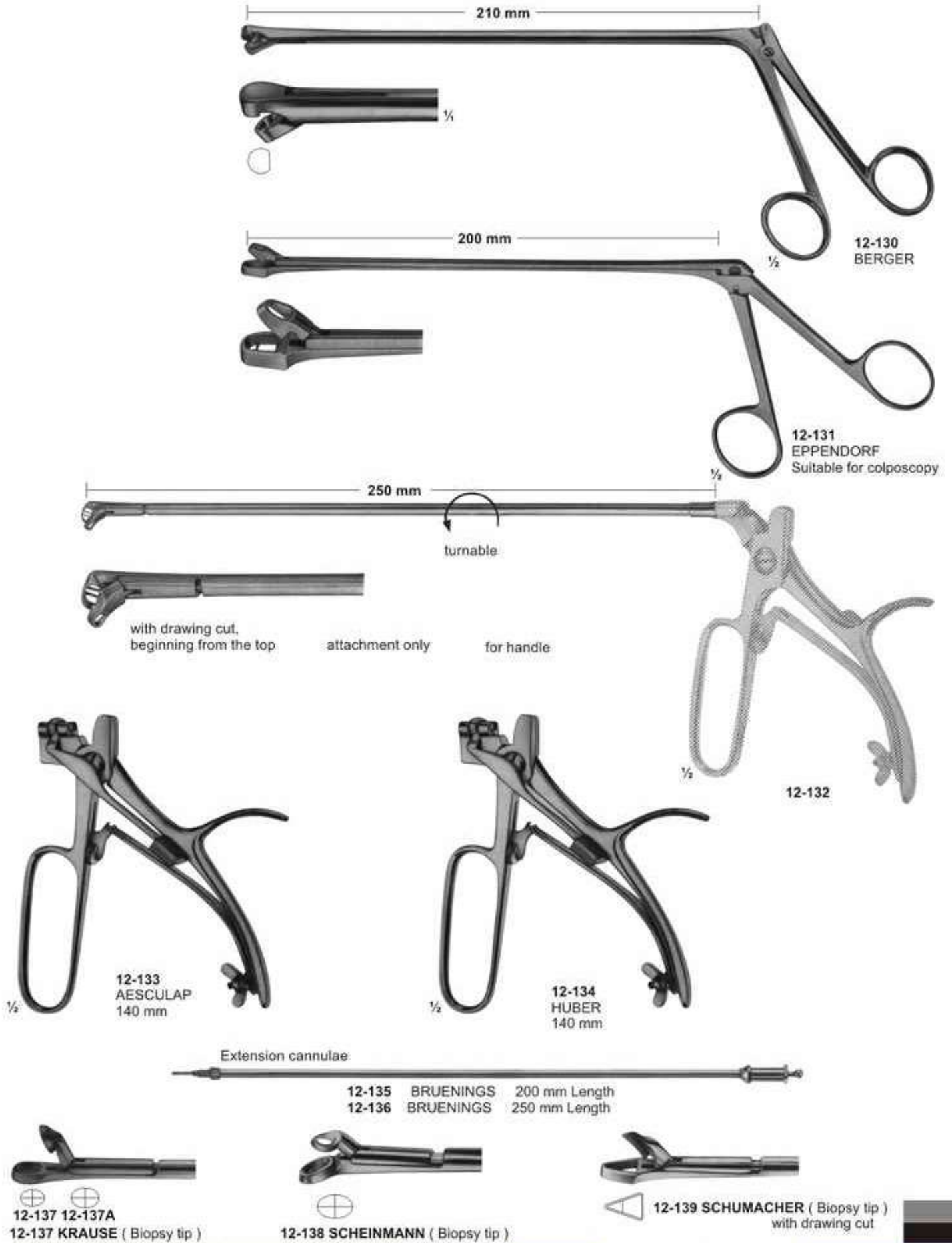

# Uterine Scoops

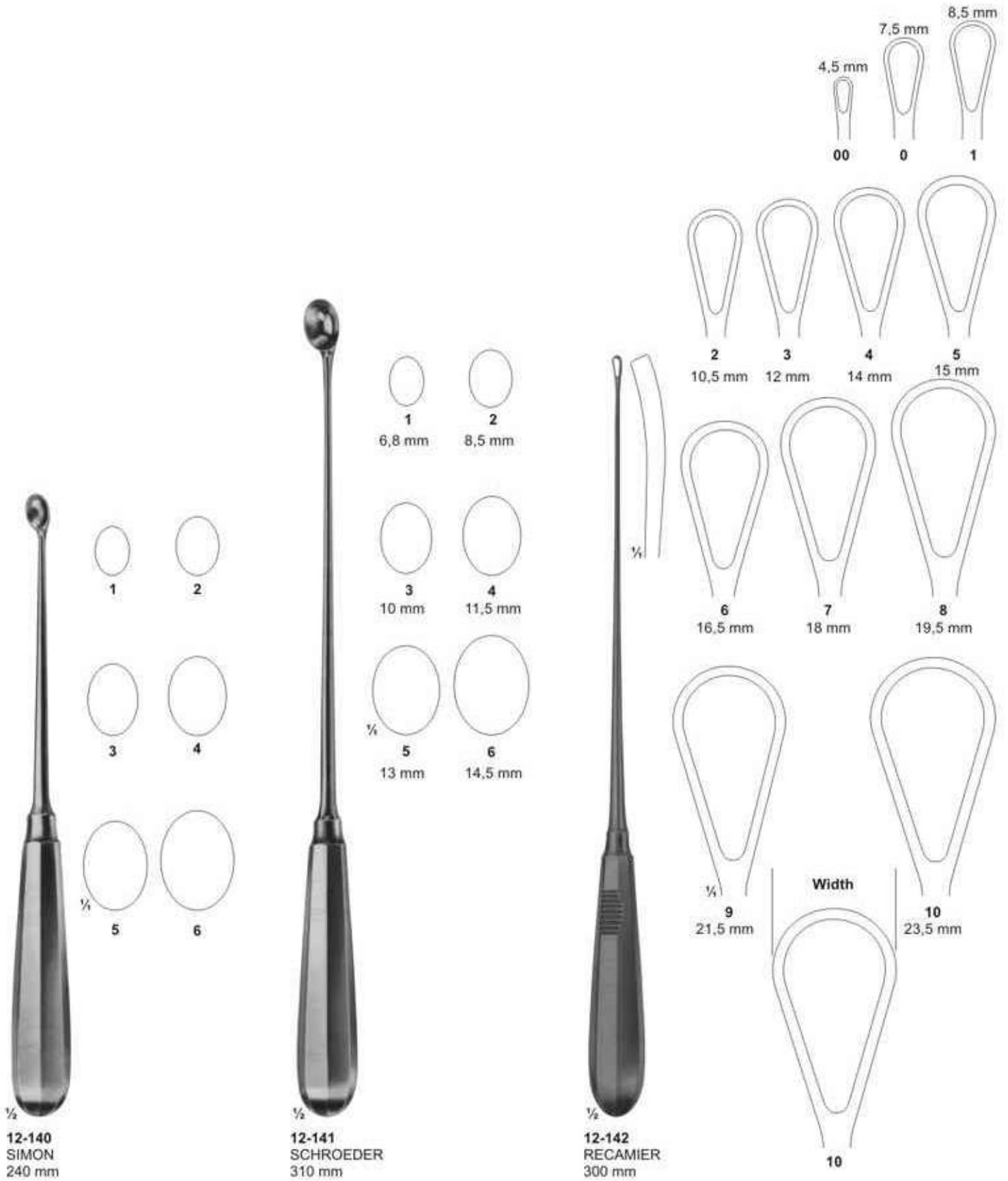



## Obstetrical Forceps



13-101  
NAEGELE  
355 mm



13-102  
NAEGELE  
400 mm



13-103  
SIMPSON-BRAUN  
305mm

## Obstetrics- Placenta and Ovum Forceps

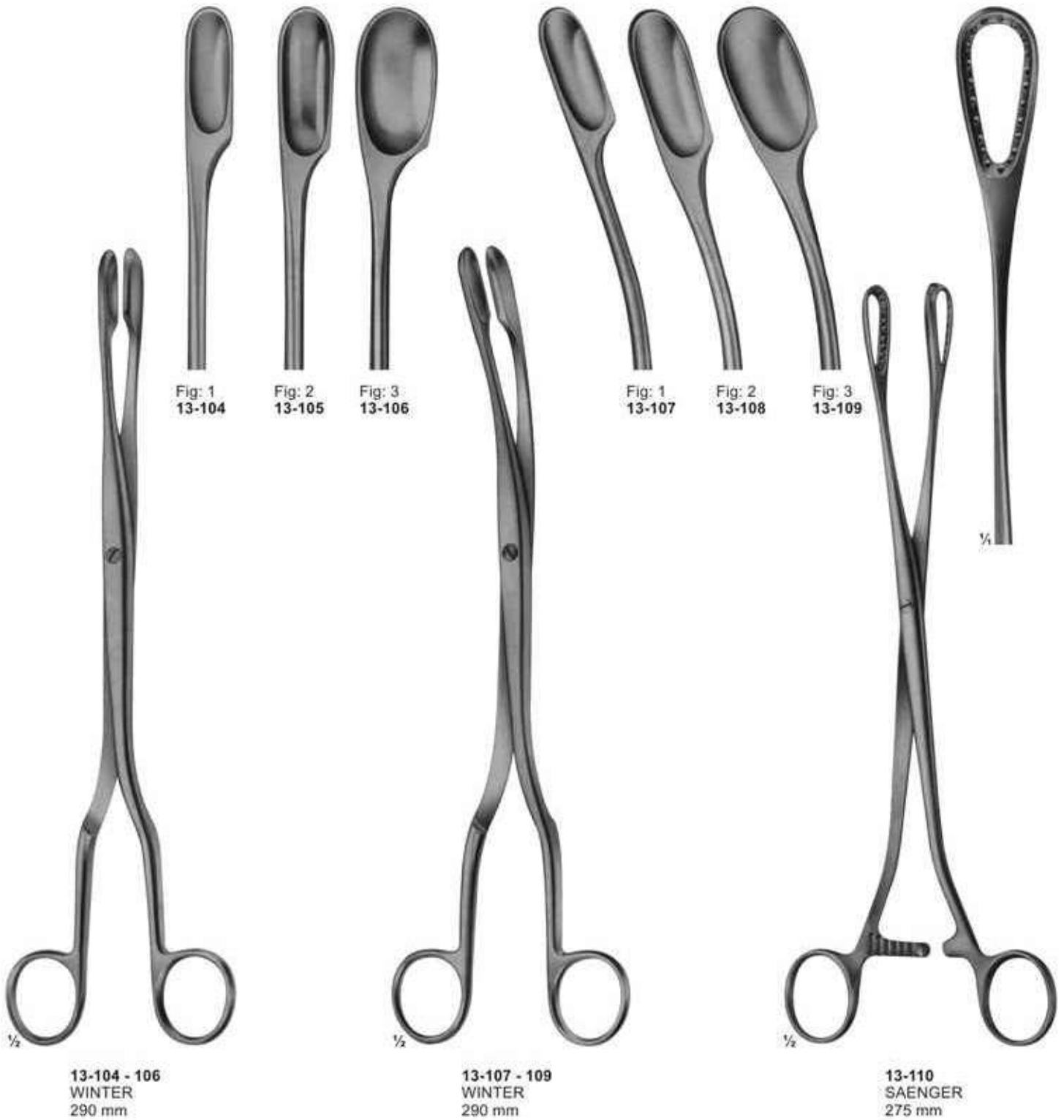

## Tound-and Tracheal Hooks and Dilators



13-111  
BOSE  
165 mm



13-112  
BOSE  
165 mm



13-113 - 115  
180 mm

13-113  
sharp



13-114  
blunt



13-115  
stumpf/blunt

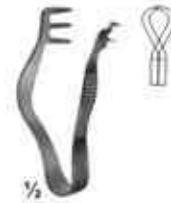

13-116  
FINSEN  
50 mm



13-117  
FINSEN  
70 mm



13-118  
TROUSSEAU  
120 mm



13-119  
LABORDE  
125 mm



13-120  
LABORDE  
strong pattern  
135 mm



13-121  
Cleaning Brush  
for tracheal tubes  
285 mm

# Vascular Spatulas

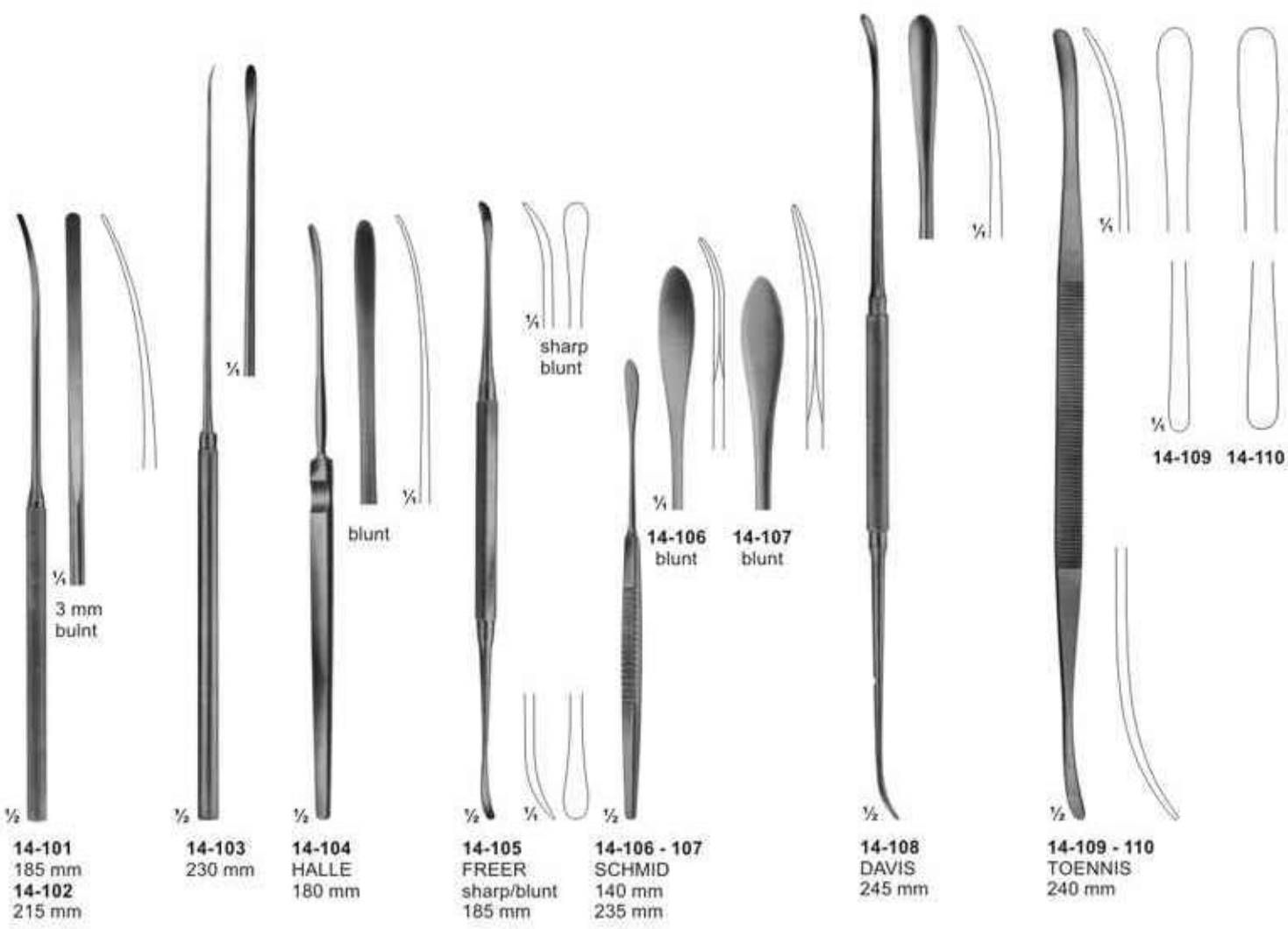

14-101  
185 mm  
14-102  
215 mm

14-103  
230 mm

14-104  
HALLE  
180 mm

14-105  
FREER  
sharp/blunt  
185 mm

14-106 - 107  
SCHMID  
140 mm  
235 mm

14-108  
DAVIS  
245 mm

14-109 - 110  
TOENNIS  
240 mm

**ATRAUMATA**  
**Forceps**

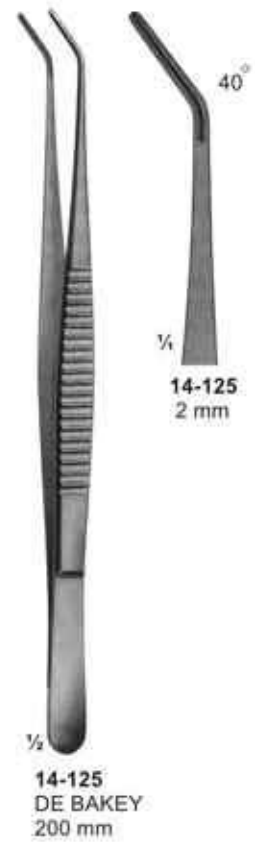
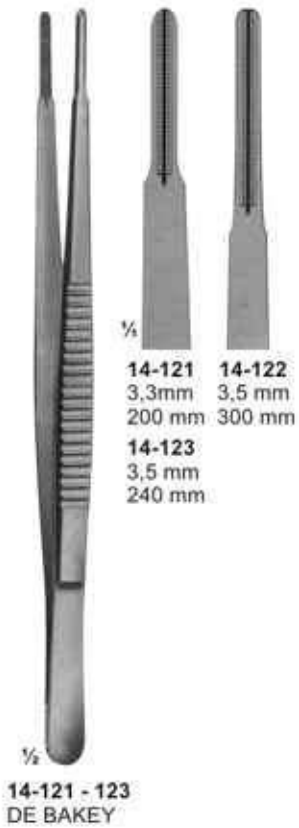
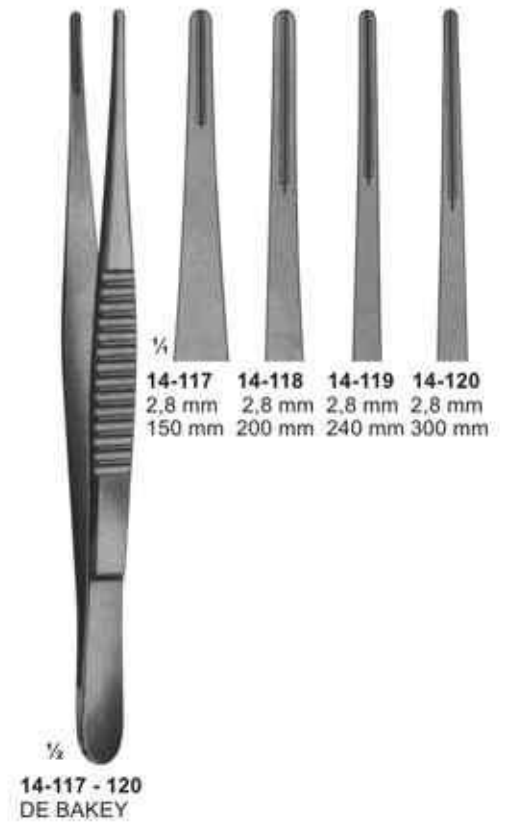
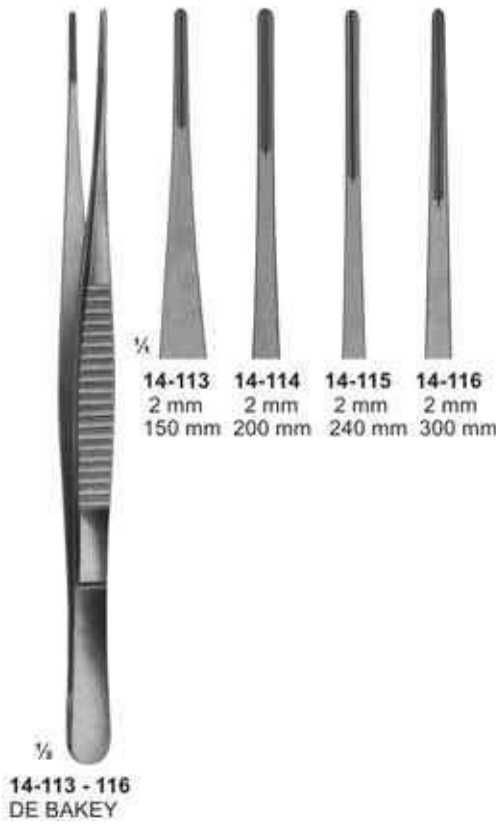
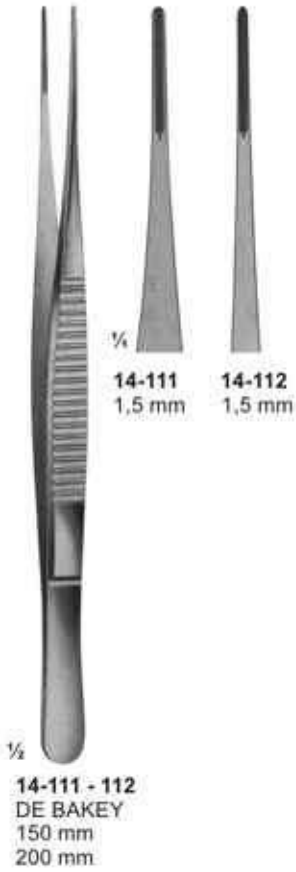

**ATRAUMATA**

**Anastomosis- and Multi- Purpose- Clamps- Pediatric types**

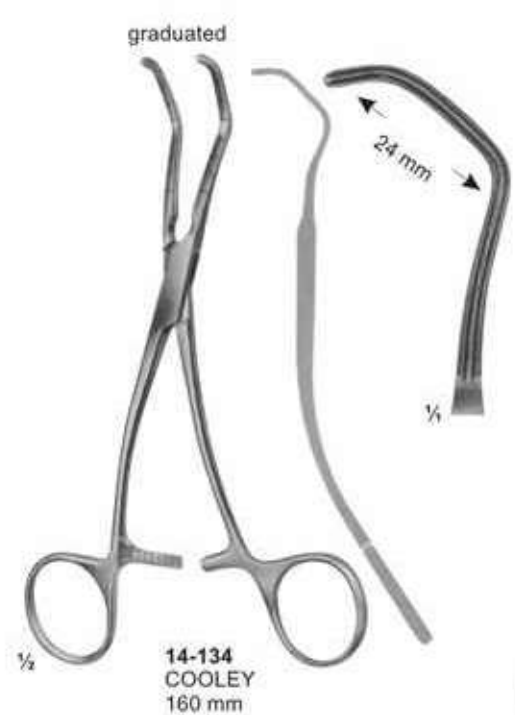
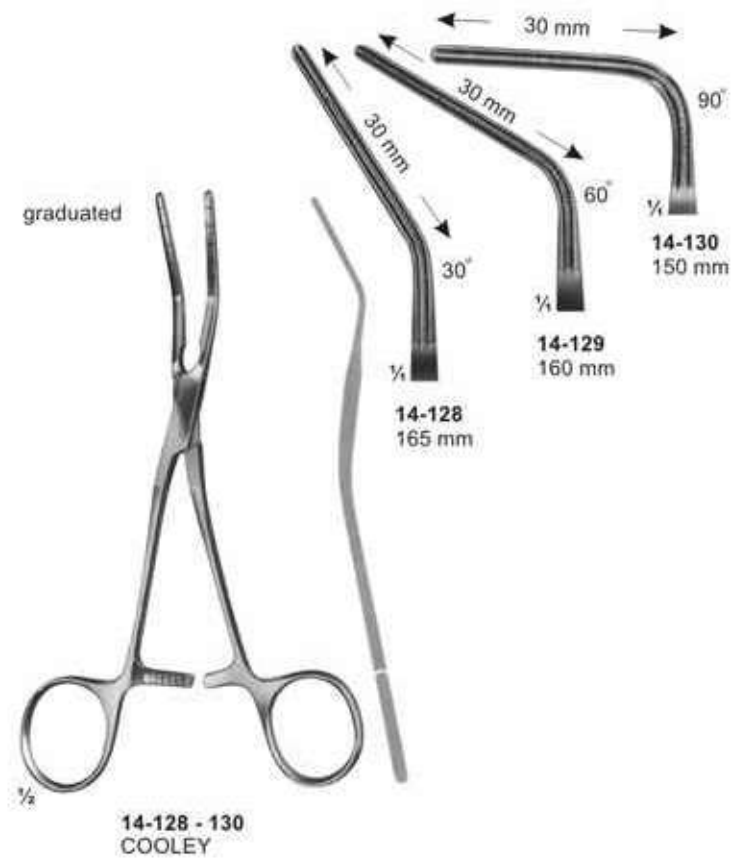
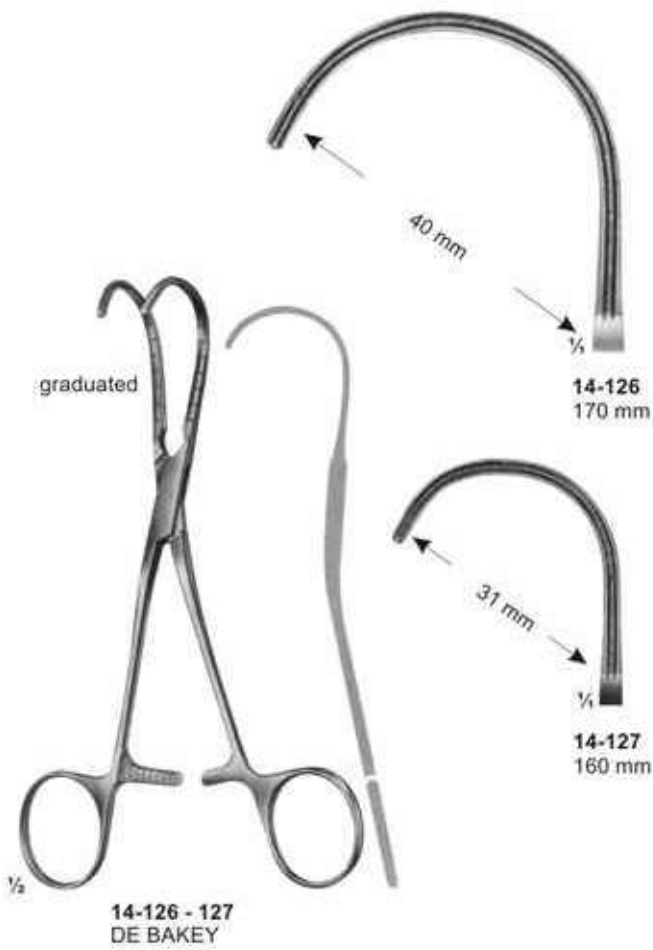

**ATRAUMATA**  
Coarctation Clamps, Patent-Ductus & Peripheral-Vascular Clamps

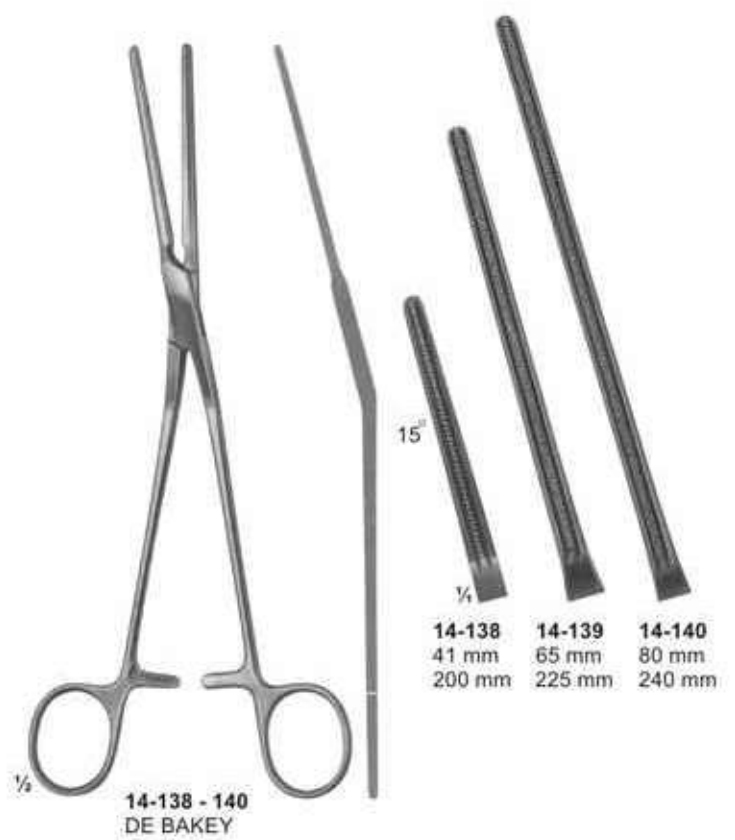

# Aorta- Anastomosis Clamps



L  
14-144  
WEBER  
260 mm



R  
14-145  
WEBER  
260 mm



## Multi- Purpose-Clamps



14-146 - 149  
DE BAKEY

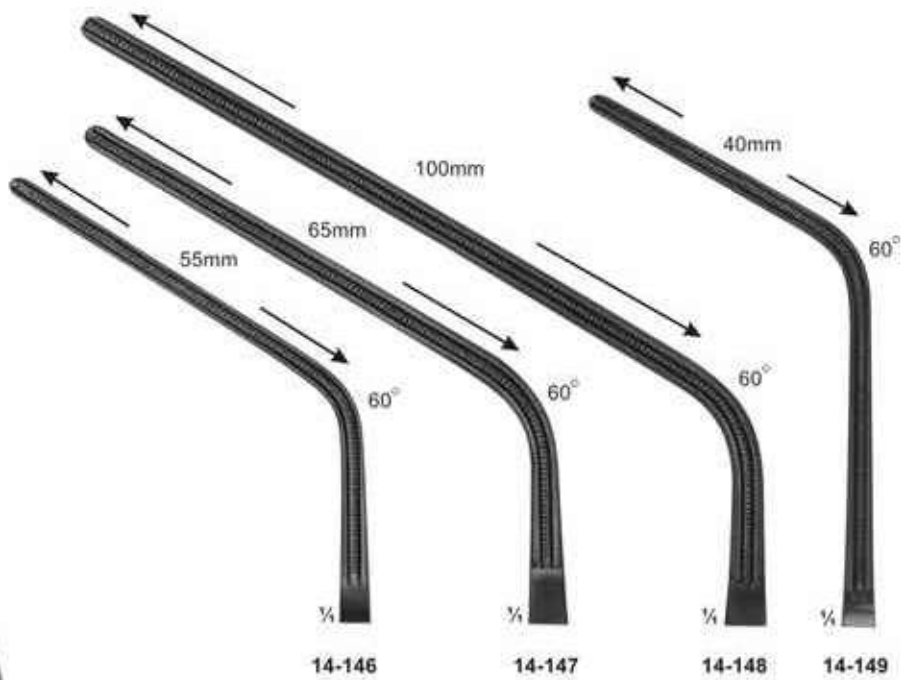

Total Length:	230 mm	280 mm	305 mm	240 mm
Length of jaws:	85 mm	100 mm	135 mm	93 mm



14-150 - 153  
DE BAKEY

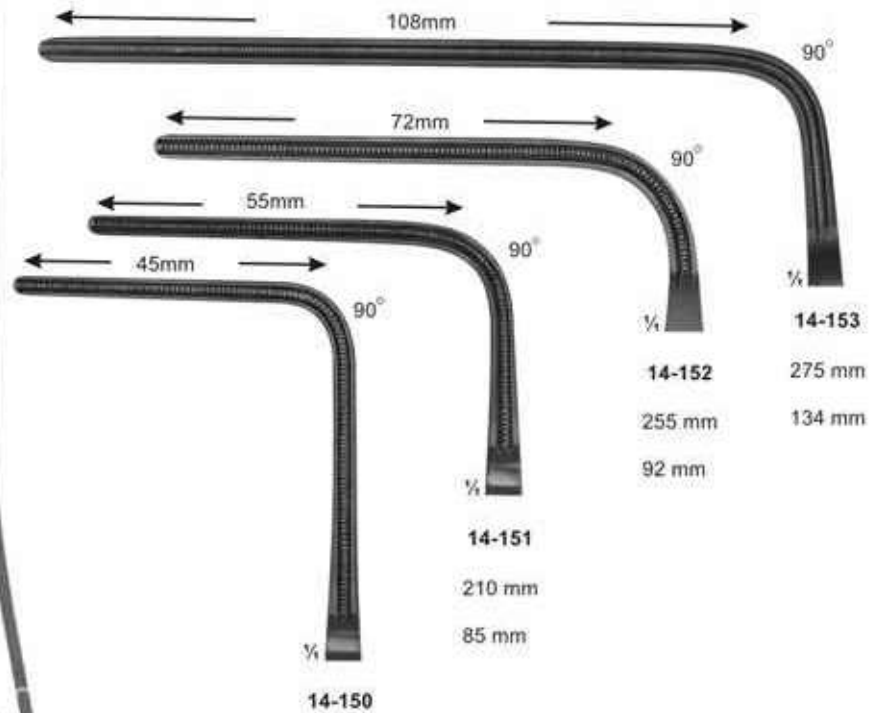

Total Length:	225 mm
Length of jaws:	93 mm

## Sternum Instruments and Rib Shears



14-154  
SCHUMACHER  
Sternum shears  
210 mm



14-155  
LEBSCHKE  
Sternum chisel  
200 mm



14-156  
230 mm



14-157  
COLLIN  
195 mm



14-158  
GLUCK  
190 mm



14-159  
BETHUNE  
340 mm



14-160  
BRUNNER  
Universal pattern  
340 mm



14-161  
GIERTZ-STILLE  
250 mm

## Rib Spreaders



**14-162**  
**FINOCHIETTO**  
 Blades  
 18X21 mm

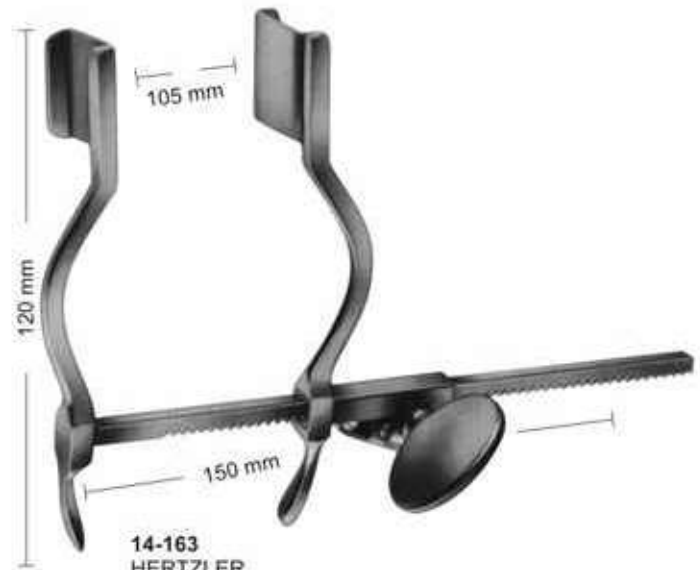

**14-163**  
**HERTZLER**  
 Blades  
 20X25 mm

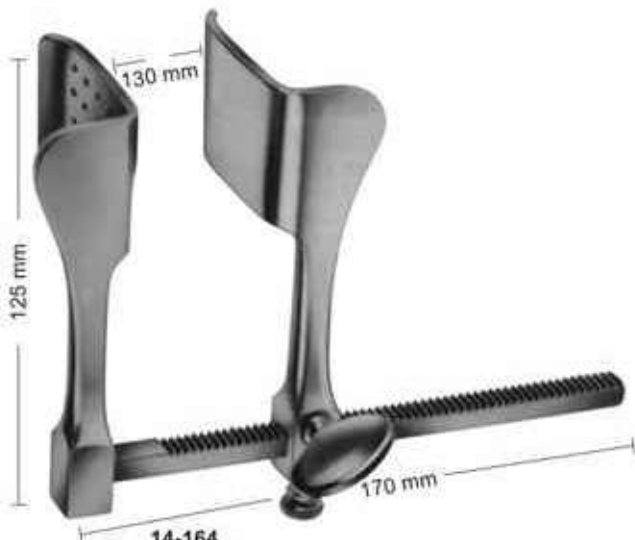

**14-164**  
**TUFFIER**  
 Blades  
 43X53 mm

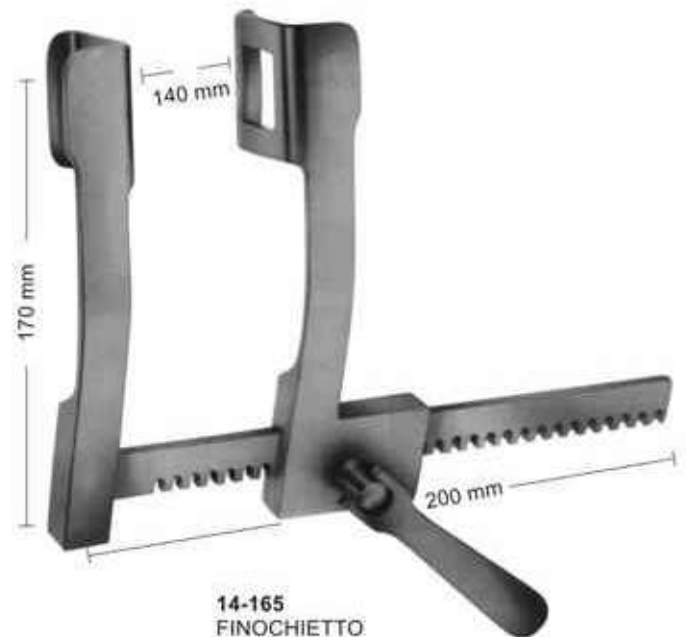

**14-165**  
**FINOCHIETTO**  
 Blades  
 36X45 mm

## Rib Spreaders-and Contractors



14-166  
SELLORS  
Rib spreader-and contractor  
with swivel blades  
200 mm



14-167  
BAILEY  
150 mm



14-168  
for children

14-169  
for adults

14-168 - 169  
BAILEY  
200 mm

# Punches

**130°** upwards cutting

**15-101**  
1 mm

KERRISON - JACOBY

FERRIS-SMITH-KERRISON

**15-102**  
2 mm

**15-103**  
3 mm

**15-104**  
4 mm

**15-105**  
5 mm

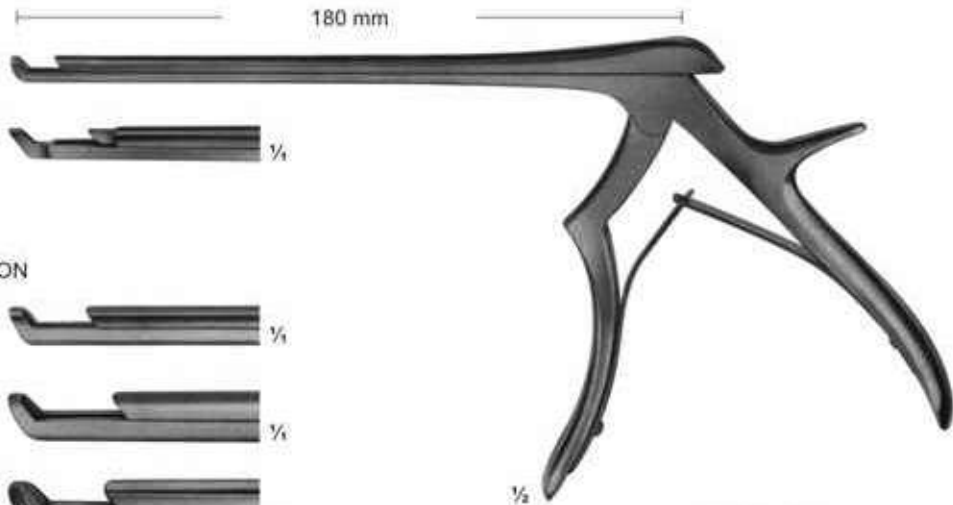

15-101 - 105

**90°** upwards cutting

KERRISON - JACOBY

**15-106**  
1 mm

**15-107**  
2 mm

FERRIS-SMITH-KERRISON

**15-108**  
3 mm

**15-109**  
4 mm

**15-110**  
5 mm

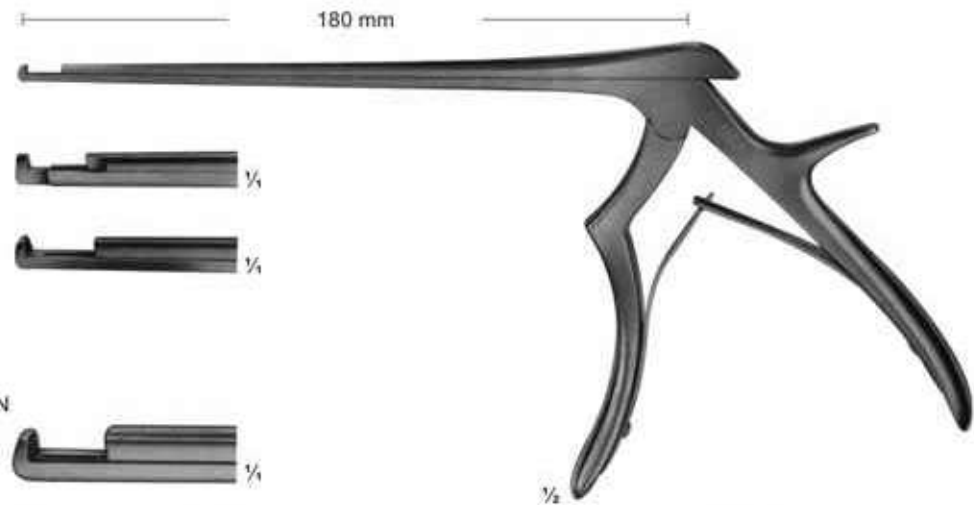

15-106 - 110

# Punches

90° upwards cutting



15-111  
4 mm



15-112  
5 mm



15-111 - 15-112  
KERRISON

90° upwards cutting

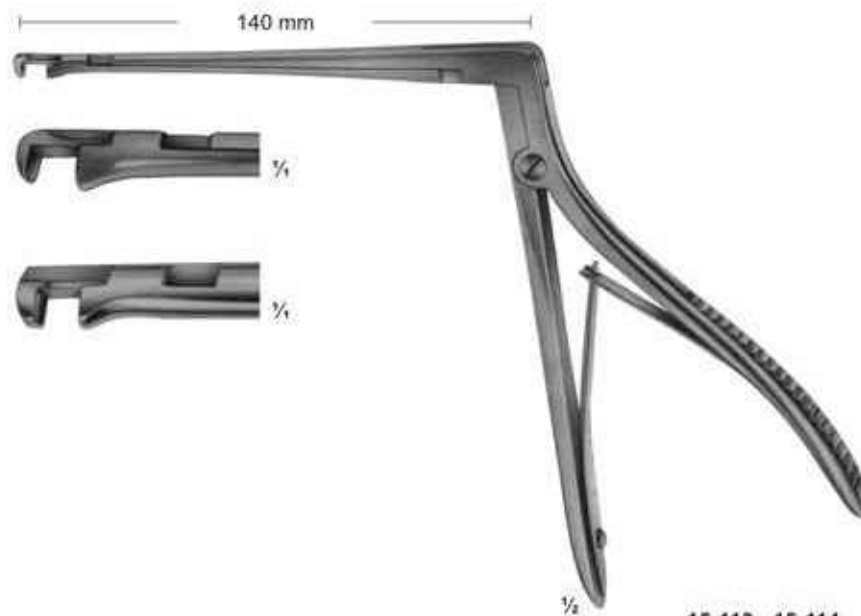

15-113  
3,3 mm



15-114  
4,0 mm



15-113 - 15-114  
HAJEK-KOFLER

Rongeurs

LOVE-GRUENWALD

15-115  
2 X 10 mm

15-116  
3 X 10 mm

SPURLING  
15-117  
4 X 10 mm

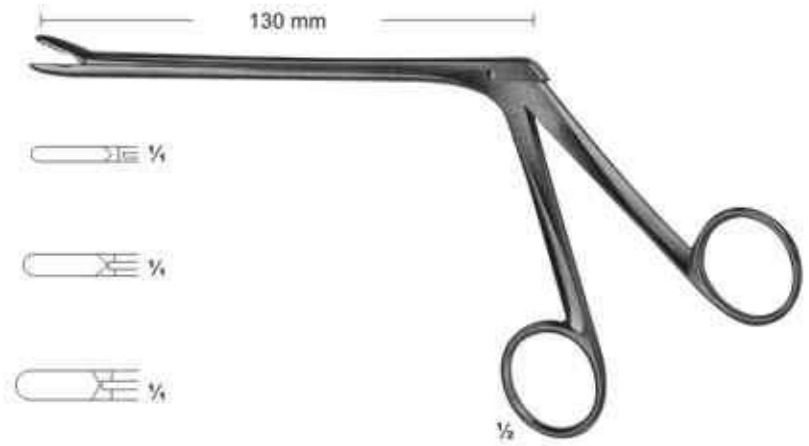

15-115 - 15-117

15-118  
2 mm

15-119  
3 mm

15-120  
4 mm

15-121  
5 mm

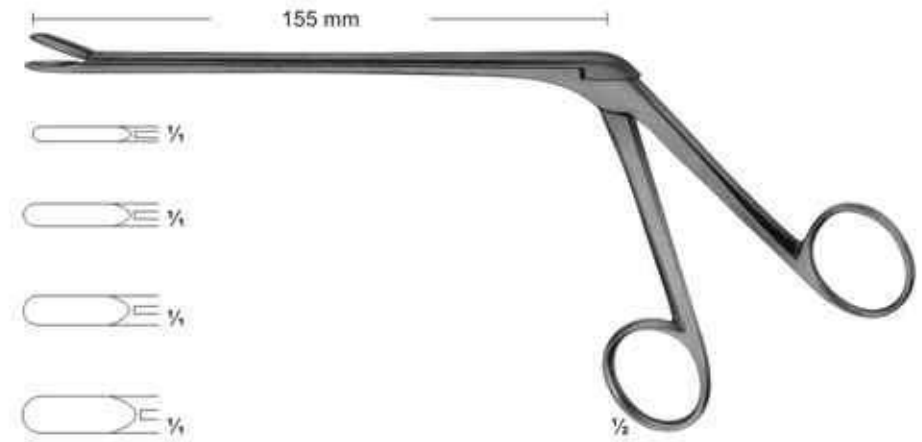

15-118 - 15-121  
CASPAR

150°

15-122  
2 mm

15-123  
3 mm

15-124  
4 mm

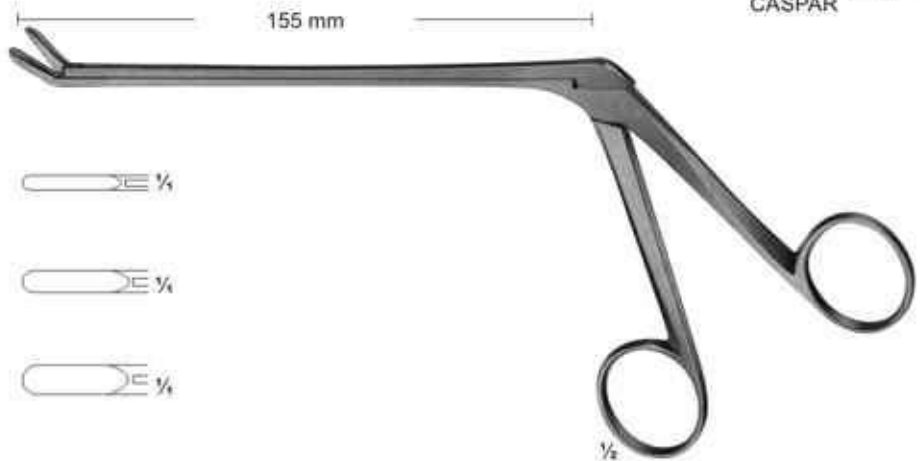

15-122 - 15-124  
CASPAR

# Rongeurs

Angled positions for rongeurs

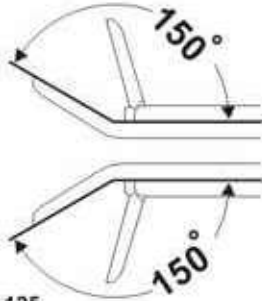

15-125  
3,0 mm

15-126  
3,6 mm

15-127  
4,2 mm

15-128  
4,8 mm

15-129  
5,8 mm

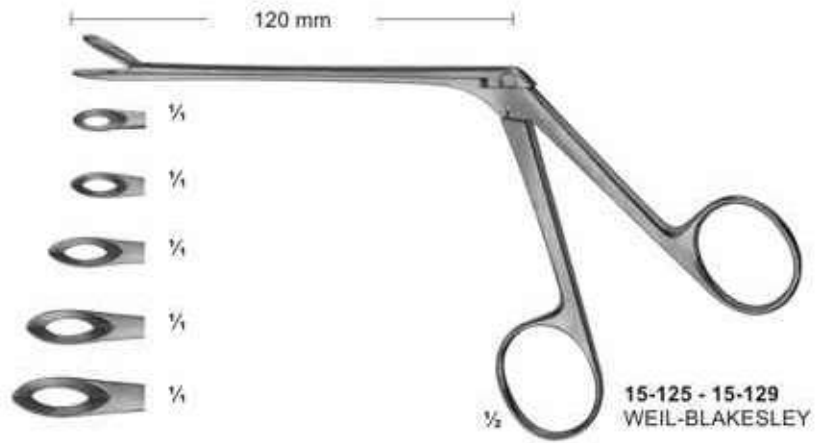
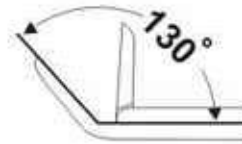
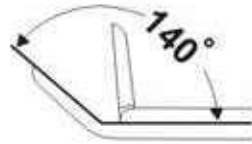

130°

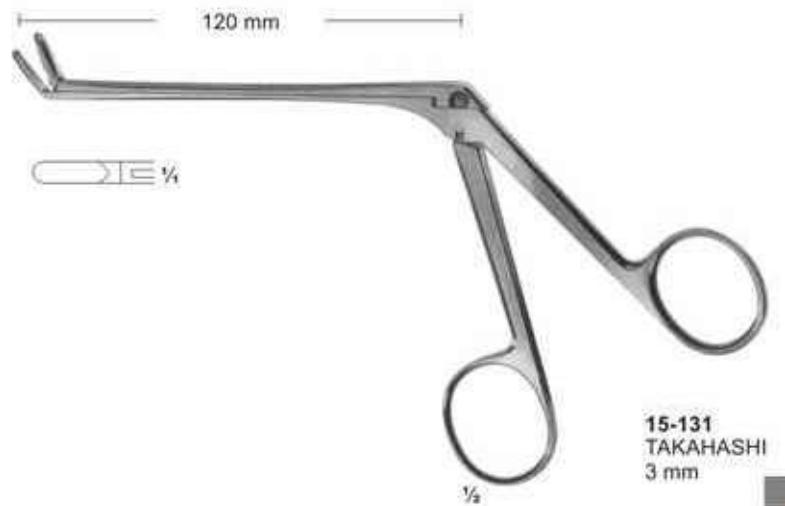



# Rongeurs

150°

Lower part of jaws movable

15-132  
2 mm

15-133  
3 mm

15-134  
4 mm



15-132 - 15-134  
CASPAR

Length of shaft 140 mm	Length of shaft 160 mm	Length of shaft 185 mm	size of jaws
15-135	15-140	15-145	2 X12 mm
15-136	15-141	15-146	3 X12 mm
15-137	15-142	15-147	4 X14 mm
15-138	15-143	15-148	5 X14 mm
15-139	15-144	15-149	6 X16 mm

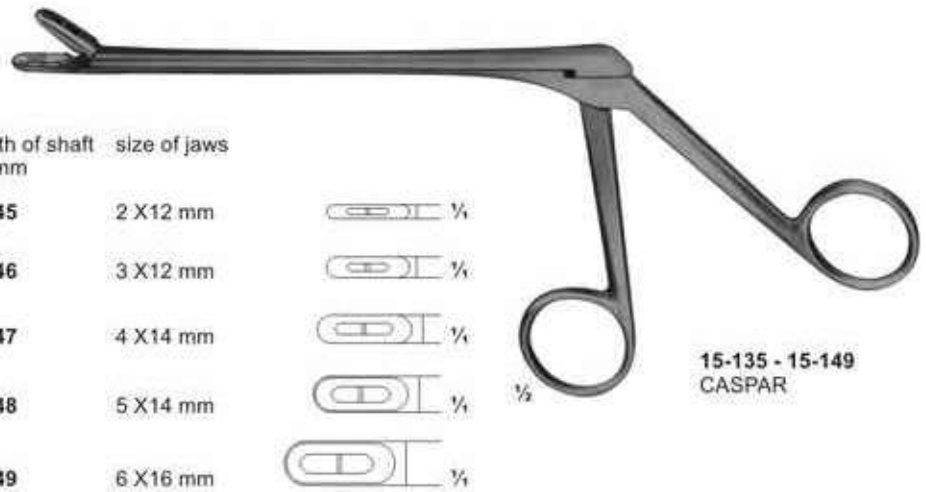

15-135 - 15-149  
CASPAR

150°

Length of shaft 140 mm	Length of shaft 160 mm	Length of shaft 185 mm	size of jaws
15-150	15-153	15-156	3 X12 mm
15-151	15-154	15-157	4 X14 mm
15-152	15-155	15-158	5 X14 mm

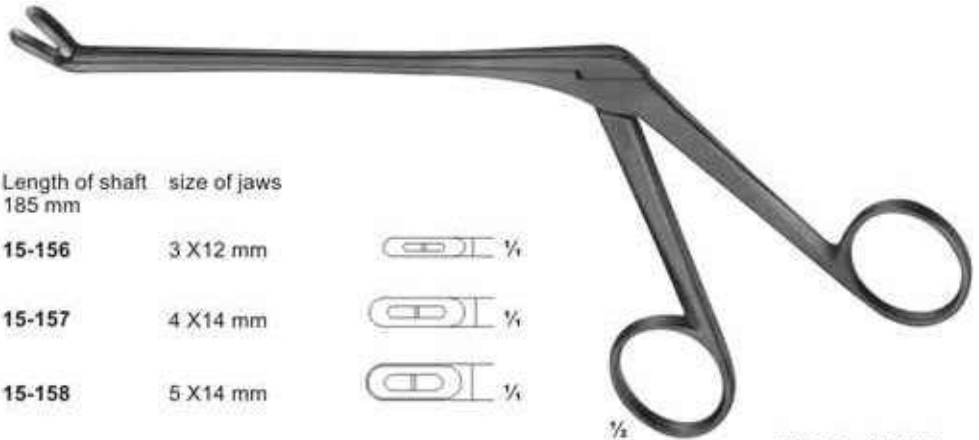

15-150 - 15-158  
CASPAR

# Rongeurs

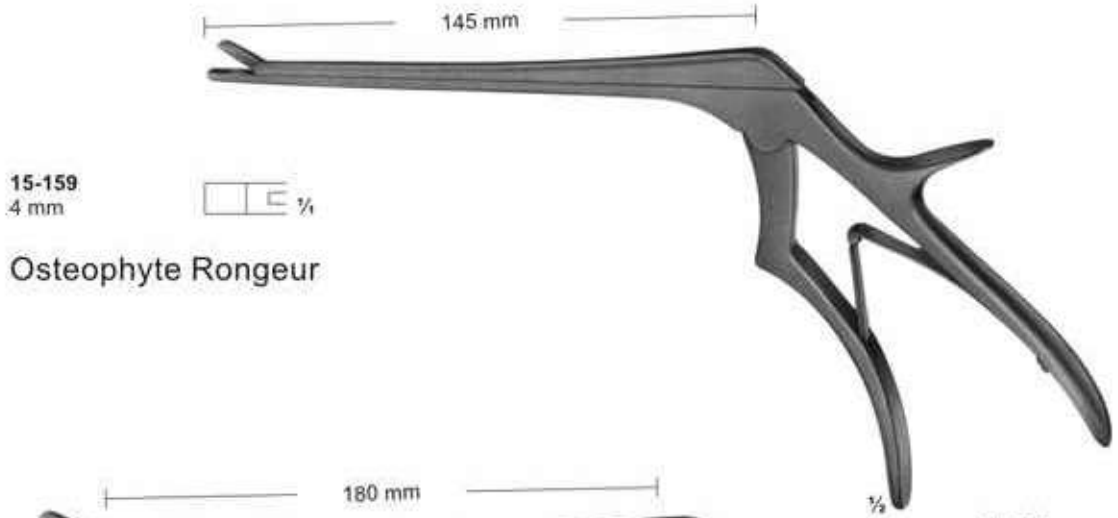

15-159  
4 mm

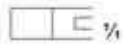

Osteophyte Rongeur

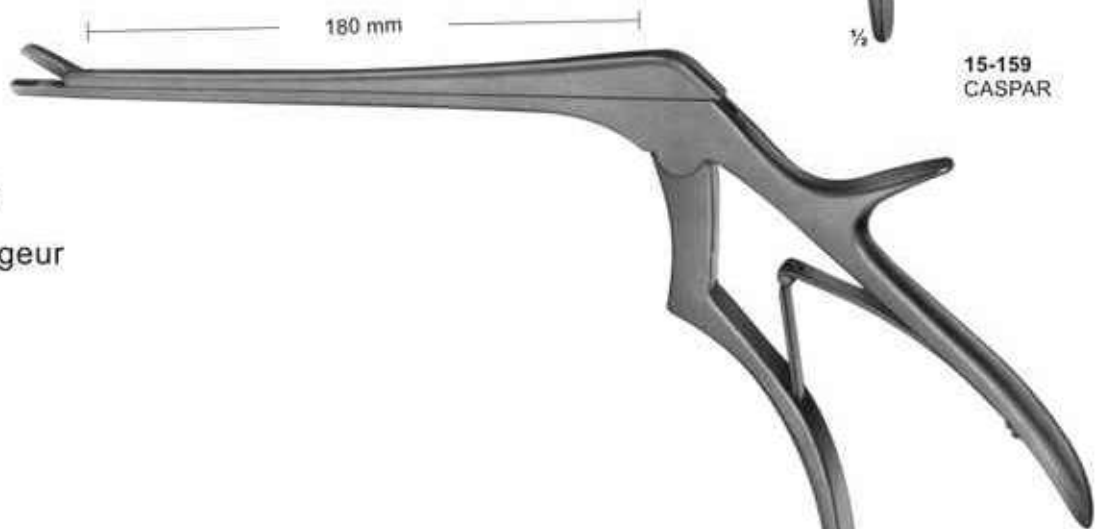

15-160  
4 mm



Osteophyte Rongeur

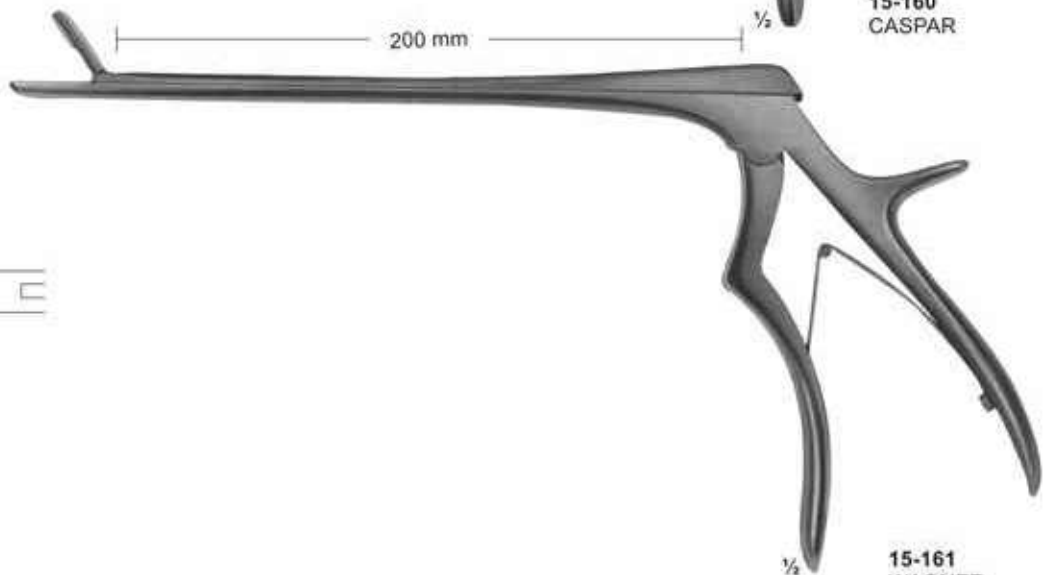

15-161  
5.5 mm



Very Heavy Pattern

15-159  
CASPAR

15-160  
CASPAR

15-161  
WAGNER

# Elevators and Bone Levers

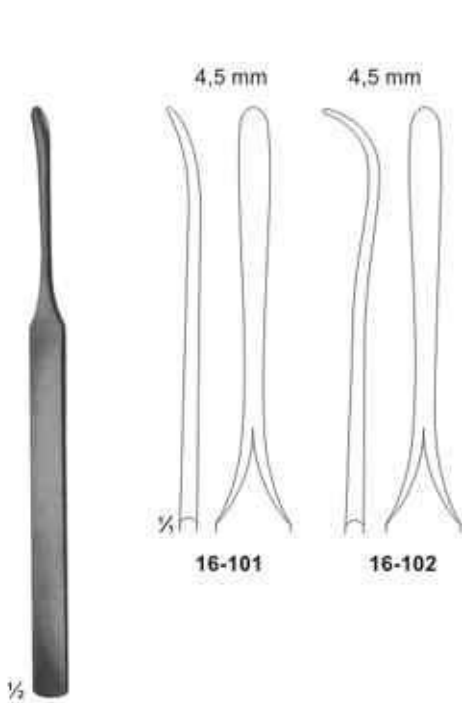

16-101 - 102  
 KONIG  
 155 mm



16-103  
 WILLIGER  
 165 mm

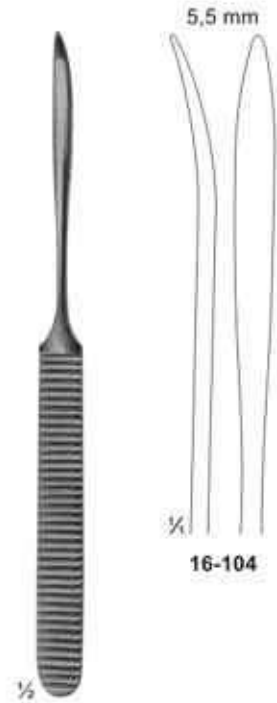

16-104  
 WILLIGER  
 170 mm

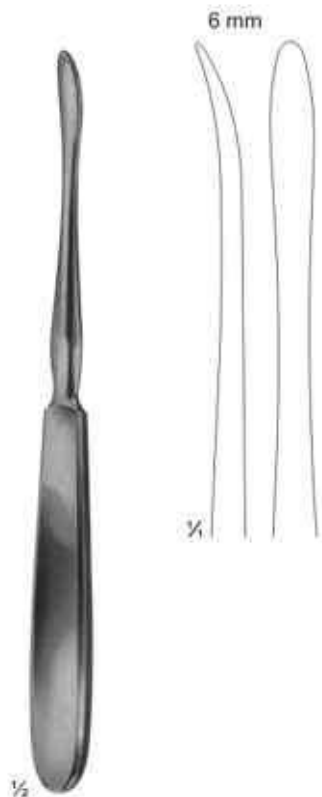

16-105  
 QUERVAIN  
 195 mm

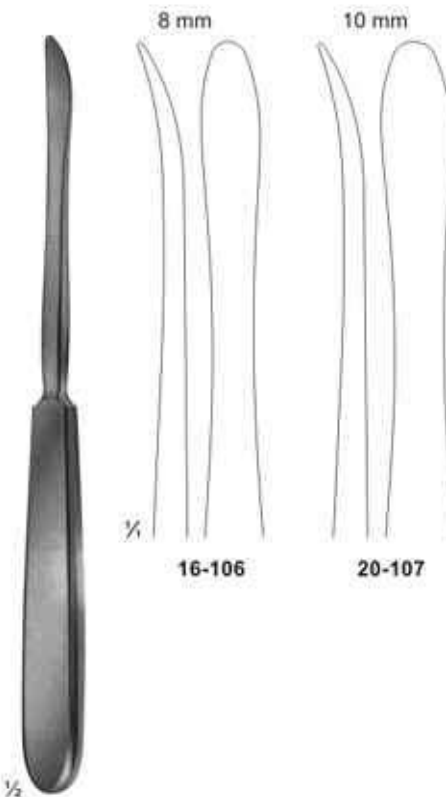

16-106 - 107  
 LANGENBACK  
 195 mm

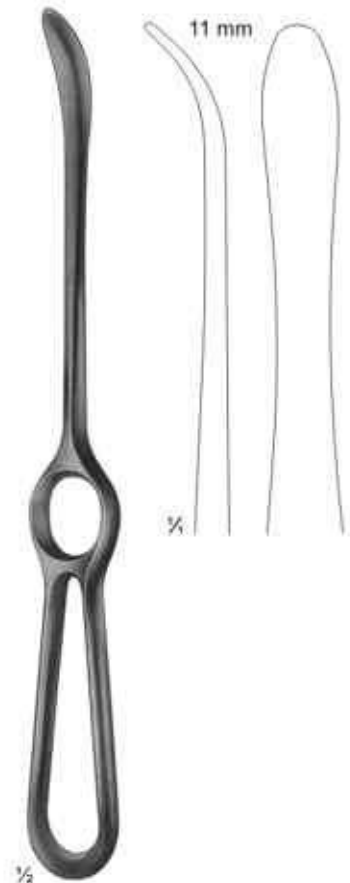

16-108  
 LANGENBACK  
 230mm

## Bone Levers



# Raspatories



**16-114**  
PARTSCH  
150 mm



**16-116**  
PARTSCH mod. LANGE  
145 mm



**16-117**  
MC KENTY  
155 mm

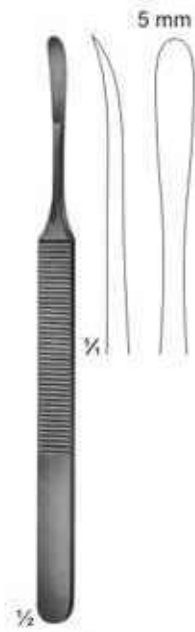

**16-118**  
KOENIG  
155 mm

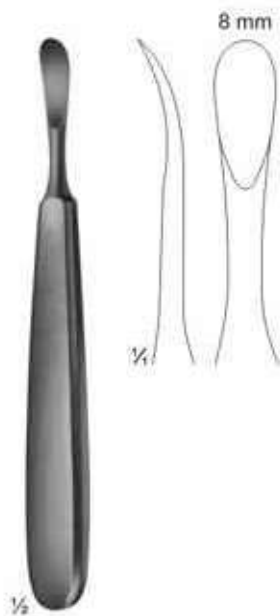

**16-119**  
TRELAT  
150 mm

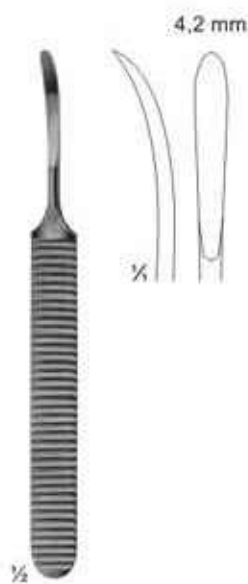

**16-120**  
WILLIGER  
140 mm



**16-121**  
WILLIGER  
160 mm



**16-122**  
JOSEPH  
170 mm

## Bone File and Rasps

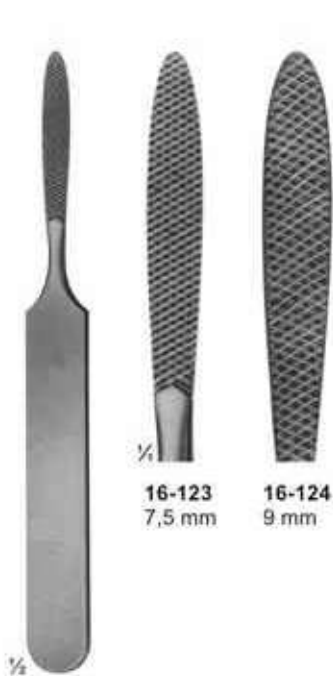

16-123  
7,5 mm

16-124  
9 mm

16-123  
JOSEPH  
fine, chequered

16-124  
coarse, chequered  
165 mm

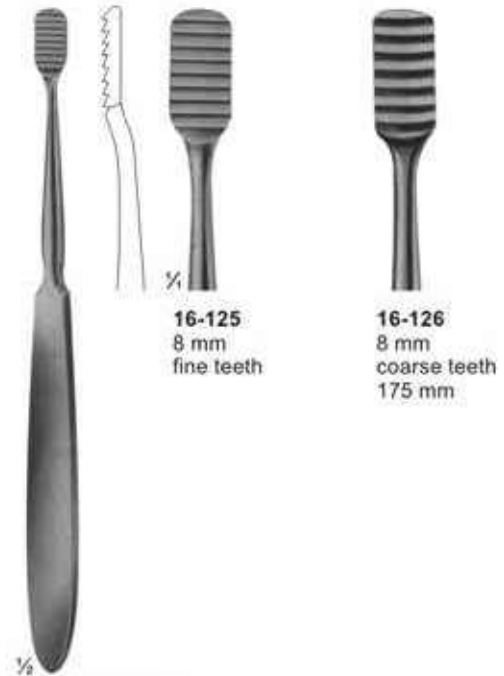

16-125  
8 mm  
fine teeth

16-126  
8 mm  
coarse teeth  
175 mm

16-125 - 16-126  
LEWIS



16-127  
9 mm

16-127  
MALTZ  
down stroke  
180 mm

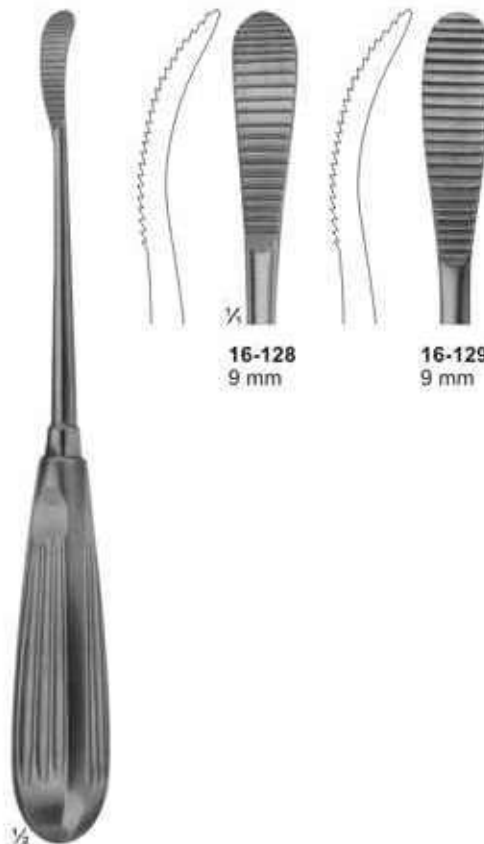

16-128  
9 mm

16-129  
9 mm

16-128 - 16-129  
AUFRICHT  
up stroke  
16-129  
down stroke  
220 mm



16-130  
6,5 mm

16-130  
GALLAHER  
190 mm

## Bone Currettes



**16-131**  
JACOBSON  
140 mm



**16-132**  
MARTINI  
140 mm



**16-133**  
MARTINI  
140 mm



**16-134**  
WILLIGER  
145 mm



**16-135**  
JANSEN  
160 mm



**16-136**  
BARTH  
180 mm



**16-137**  
VOLKMANN  
130 mm



**16-138**  
VOLKMANN  
145 mm



**16-139**  
VOLKMANN  
170 mm

**Mallets** Weights refer to the heads of the mallets  
**Hammer** Die Gewichtsangaben beziehen sich auf den Kopf des jeweiligen Hammers



∅ 20 mm

½

**17-101**  
MEAD  
185 g  
with interchangeable  
plastic disks  
190 mm  
**17-102**  
pair of spare disks



∅ 25 mm

½

**17-103**  
140 g  
with interchangeable  
plastic disks  
185 mm  
**17-104**  
pair of spare disks



∅ 30 mm

½

**17-105**  
COTTLE  
140 g  
1 Side Flat  
1 Side convex  
185 mm



∅ 22 mm

½

**17-106**  
165 g  
lead filled head  
190 mm



# Osteotomes, Chisels and Gouges



17-107  
MANNERFELT  
Gouge  
155 mm

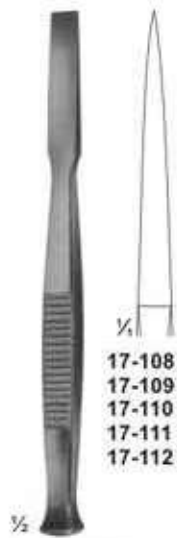

17-108 - 112  
Osteotomes  
140 mm

17-108 4 mm  
17-109 6 mm  
17-110 8 mm  
17-111 10 mm  
17-112 12 mm



17-113 - 117  
Chisels  
140 mm

17-113 4 mm  
17-114 6 mm  
17-115 8 mm  
17-116 10 mm  
17-117 12 mm



17-118 - 122  
Gouges  
140 mm

17-118 4 mm  
17-119 6 mm  
17-120 8 mm  
17-121 10 mm  
17-122 12 mm



PARTSCH  
17-123 - 126  
Chisels  
140 mm

17-123 3 mm  
17-124 4 mm  
17-125 5 mm  
17-126 6 mm

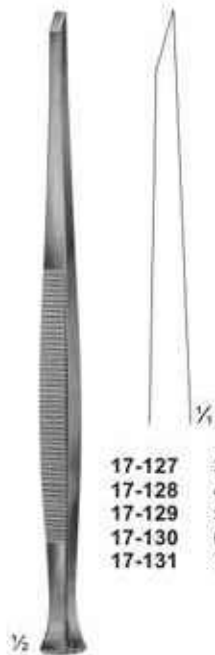

PARTSCH  
17-127 - 131  
Chisels  
170 mm

17-127 3 mm  
17-128 4 mm  
17-129 5 mm  
17-130 6 mm  
17-131 7 mm



PARTSCH  
17-132 - 135  
Gouges  
140 mm

17-132 3 mm  
17-133 4 mm  
17-134 5 mm  
17-135 6 mm



PARTSCH  
17-136 - 140  
Gouges  
170 mm

17-136 3 mm  
17-137 4 mm  
17-138 5 mm  
17-139 6 mm  
17-140 7 mm



LUCAS  
17-141 - 142  
Chisels  
160 mm

17-141 4 mm  
17-142 6 mm



LUCAS  
17-143 - 144  
Gouges  
160 mm

17-143 3 mm  
17-144 5 mm

## Reposition Forceps, Bone Holding Forceps



**17-145**  
Patella forceps  
185 mm



**17-146**  
Forceps with  
ratchet fixation  
140 mm



**17-147**  
Forceps with  
thread fixation  
170 mm



**17-148**  
Forceps with  
thread fixation  
235 mm

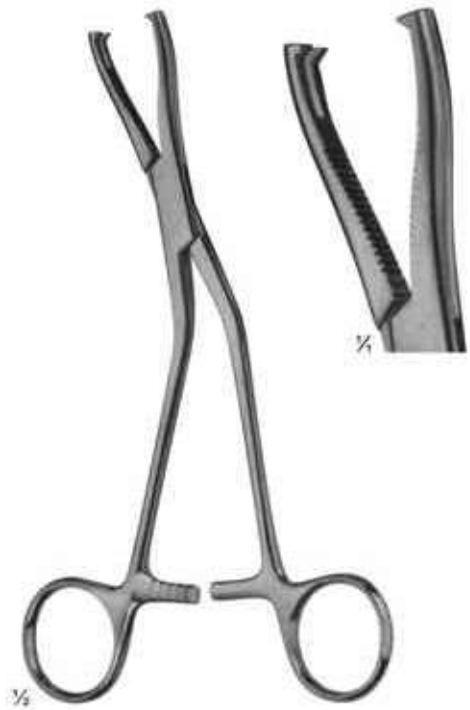

**17-149**  
DINGMANN  
185 mm

## Bone Holding Forceps & Bone Clamps



# Bone Rongeurs



17-158  
LUER  
150 mm



17-159  
LUER  
155 mm



17-160  
BLUMENTHAL  
155 mm



17-161  
BLUMENTHAL  
150 mm



17-162 - 163  
JANSEN  
175 mm



17-164  
BANE-HARTMANN  
175 mm

## Bone Rongeurs



17-165  
STILLE  
235 mm.



17-166  
LEKSELL-STILLE  
240mm



17-167  
STILLE-RUSKIN  
240mm

## Bone Cutting Forceps



**17-168**  
LISTON  
curved on flat  
240 mm



**17-169**  
LISTON  
straight  
280 mm

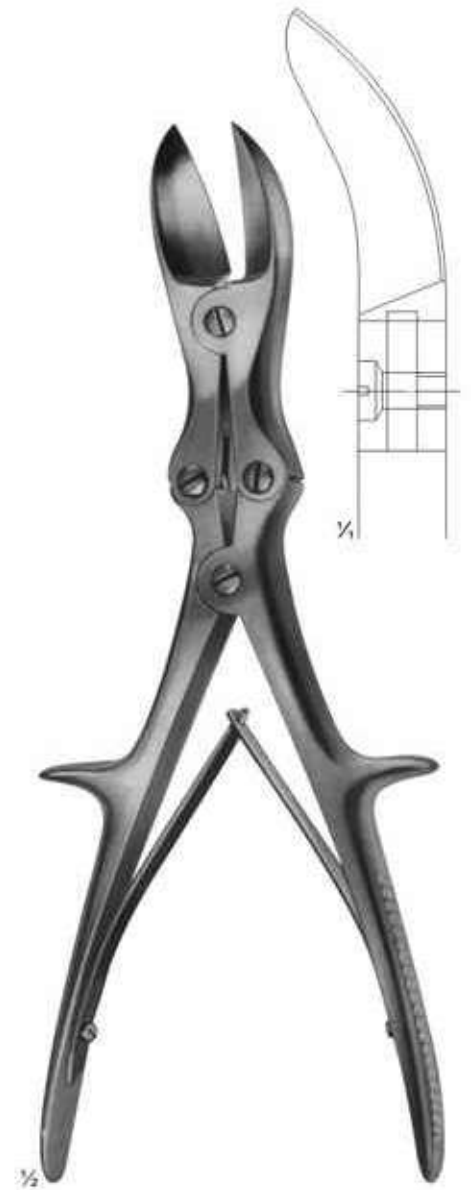

**17-170**  
LISTON  
curved on flat  
280 mm

## Wire Extension

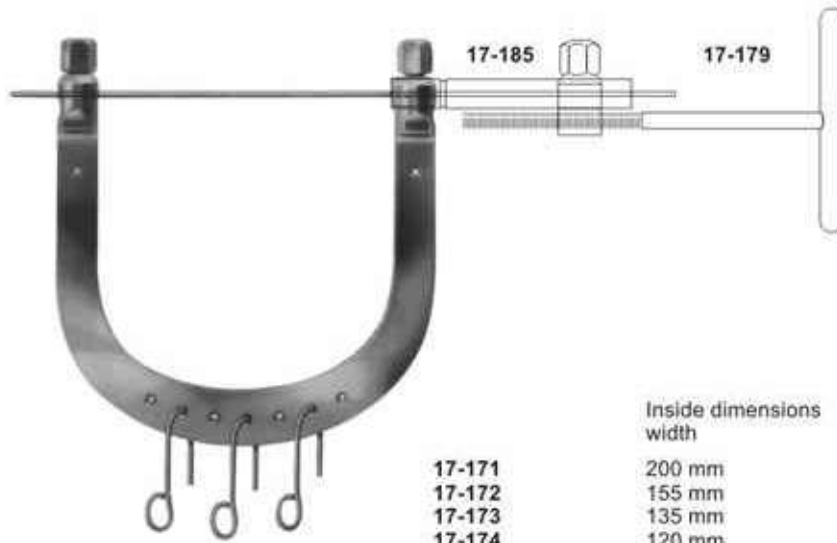

**17-171 - 17-177**  
**KIRSCHNER**  
Wire traction bows,  
to be used with  
KIRSCHNER-wires  
up to 2.5 mm diam.,  
With 3 hooks,  
stainless steel

	Inside dimensions width	depth	
17-171	200 mm	155 mm	for the hip
17-172	155 mm	155 mm	for the femur
17-173	135 mm	130 mm	for the knee
17-174	120 mm	120 mm	for the knee
17-175	105 mm	100 mm	for the knee
17-176	95 mm	110 mm	for the calcaneus
17-177	95 mm	70 mm	for the arm and elbow



**17-178**  
Wrench, double - ended,  
for wire traction bows



**17-179**  
Wire tightener, with  
clamping jaws



**17-182** max. 105 mm  
**17-183** max. 160 mm  
**17-184** max. 200 mm

**17-182** 80-95 mm  
**17-183** 90-120 mm  
**17-184** 140-170 mm

diam upto

**17-182** 1,6 mm  
**17-183** 2,0 mm  
**17-184** 2,5 mm

**17-182 - 17-184**  
**KIRSCHNER**  
Wire traction bows, modified,  
adjustable in width, holds wire  
securely, with 1 hook



**17-185**  
Fixation clamp, to secure clamping  
jaws of 17-179 stainless steel



**17-180**  
Traction hook only,  
large size



**17-181**  
Traction hook only,  
small size

# Cerclage Instruments

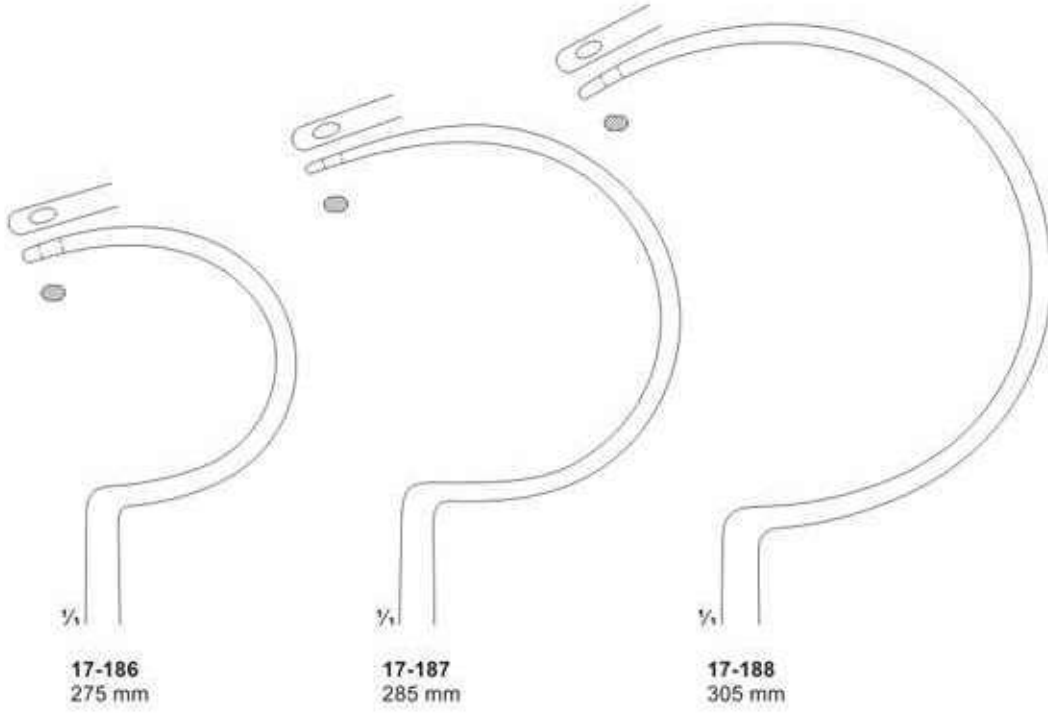

17-186  
275 mm

17-187  
285 mm

17-188  
305 mm



17-186 - 17-188  
DEMEL  
Wire guides

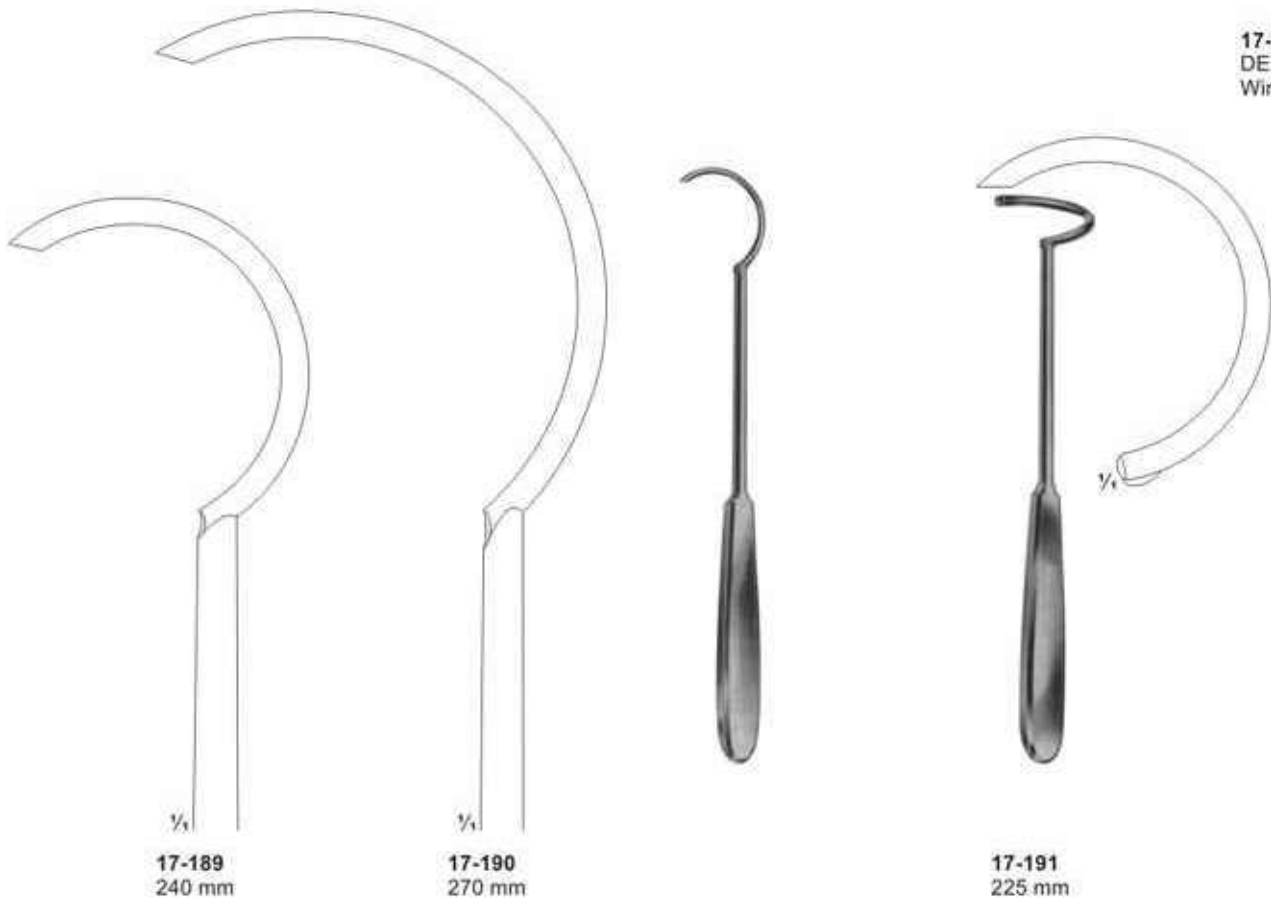

17-189  
240 mm

17-190  
270 mm

17-191  
225 mm



## Wire Holding forceps, Wire Tightening Pliers, Flat-nosed Pliers DUROGRIP with Hard Metal Inserts



**17-192**  
DUROGRIP  
Holding forceps for cerclage  
wire, with lateral jaws to avoid  
wire slipping off  
170 mm



**17-193**  
DUROGRIP  
Wire, tightening pliers,  
Ligature pliers  
150 mm



**17-194**  
DUROGRIP  
Wire, tightening pliers,  
Ligature pliers  
150 mm



**17-195**  
with serrated jaws  
140 mm



**17-196**  
one jaw smooth,  
one jaw serrated  
140 mm



**17-197**  
with serrated jaws  
**17-198**  
with longitudinal and  
transversal grooves  
170 mm



**17-199**  
190 mm

# Wire Holding forceps, Flat-nosed Pliers, Pliers for bending and cutting wires



17-200  
130 mm

17-201  
180 mm



17-200 - 17-201  
Extraction pliers  
for boring wires



17-202  
Flat-nosed pliers,  
parallel  
185 mm



17-203  
Vise grip  
200 mm



17-204  
Round Pliers  
180mm



17-204



17-204



17-205



17-206



17-207

17-205 145 mm  
17-206 180 mm  
17-207 180 mm  
Extraction pliers for wires



17-208  
Bending pliers  
for wires up to  
1.8 mm diam.

# Wire Cutters and wire Cutting Scissors DUROTIP with Carbide Cutting Edges



**17-209**  
ANGLE  
130 mm

for soft wire  
up to diam.  
for hard wire  
up to diam.

0,5 mm  
0,3 mm

**17-210**  
DUROTIP  
ANGLE  
130 mm

0,6 mm  
0,4 mm

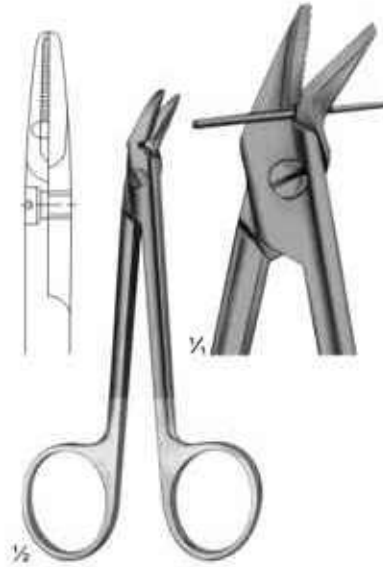

**17-211**  
120 mm

for soft wire  
up to diam.  
for hard wire  
up to diam.

1,2 mm  
0,8 mm

**17-212**  
DUROTIP  
120 mm

1,2 mm  
0,8 mm



**17-213**  
HARVEY  
125 mm

0,4 mm  
0,3 mm



**17-214**  
150 mm

for soft wire  
up to diam  
for hard wire  
up to diam

1,5 mm  
1,0 mm



**17-215**  
160 mm

1,5 mm  
1,2 mm



**17-216**  
140 mm  
DUROTIP  
1,5 mm

1,0 mm

## Wire Cutting Pliers, Lateral Cutting Action



**17-217**  
180 mm

for soft wire  
up to diam. 2,0 mm  
For hard wire 1,5 mm  
up to diam  
specially hardened  
cutting edges, front  
and lateral cutting  
action



**17-218**  
REILL  
175 mm

for soft wire  
up to diam. 2,0 mm  
For hard wire 1,6 mm  
up to diam  
specially hardened  
cutting edges, for  
cutting off wires close  
to the bone



**DUROTIP**

**17-219**  
235 mm

for soft wire  
up to diam. 3,0 mm  
For hard wire 2,2 mm  
up to diam

# Wire Cutting Pliers, Lateral and Front Cutting Action



17-220  
240 mm

for soft wire up to diam. 2,0 mm  
For hard wire up to diam 1,6 mm



17-221  
145 mm

for soft wire up to diam. 1,5 mm  
For hard wire up to diam 1,0 mm



17-222  
145 mm

for soft wire up to diam. 2,0 mm  
For hard wire up to diam 1,5 mm



17-223  
220 mm

for soft wire up to diam. 3,5 mm  
For hard wire up to diam 2,5 mm

## Wire Cutting Pliers



**17-224**  
320 mm

for soft wire  
up to diam. 3,0 mm  
For hard wire  
up to diam. 3,0 mm



Cutter for cutting off  
KIRSCHNER wires,  
Tibia head screws,  
bolts, pins, up to 3 mm diam.



**DUROTIP**

**17-225**  
Cutter for cutting off  
KIRSCHNER wires,  
Tibia head screws,  
bolts, pins, up to 6 mm diam.  
470 mm

## Finger Nail Instruments

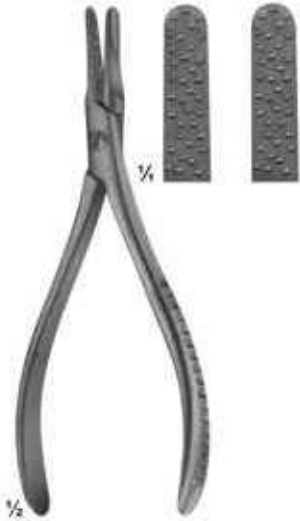

**17-226**  
Nail extracting  
forceps  
135 mm



**17-227**  
Nail extracting  
forceps  
145 mm



**17-228**  
Finger nail drill  
with 3 drill points.

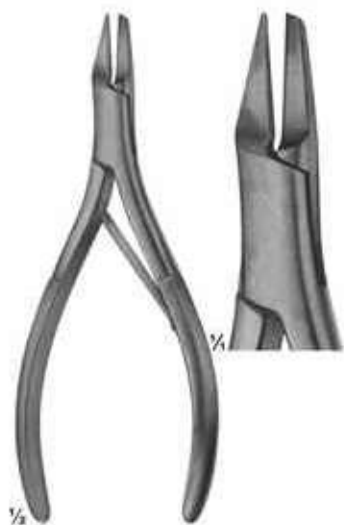

**17-231**  
Nail splitting  
forceps  
135 mm



**17-232**  
SYSTRUNK  
Scissors, for splitting  
finger nails  
130 mm



**17-233**  
Finger ring saw  
150 mm

# Plaster Shears



17-235  
STILLE-AESCULAP  
260 mm



17-236  
STILLE-AESCULAP  
360 mm



# Plaster Spreader, Plaster Breakers



17-237  
HENING  
270 mm



17-238  
MOD.USA  
230 mm



17-239  
290 mm



with removable jaws



17-240 - 17-241  
WOLFF  
17-240 180 mm  
17-241 240 mm  
plaster breakers

## Vacuum Currettes for Aspiration Lipectomy, Suction Instruments

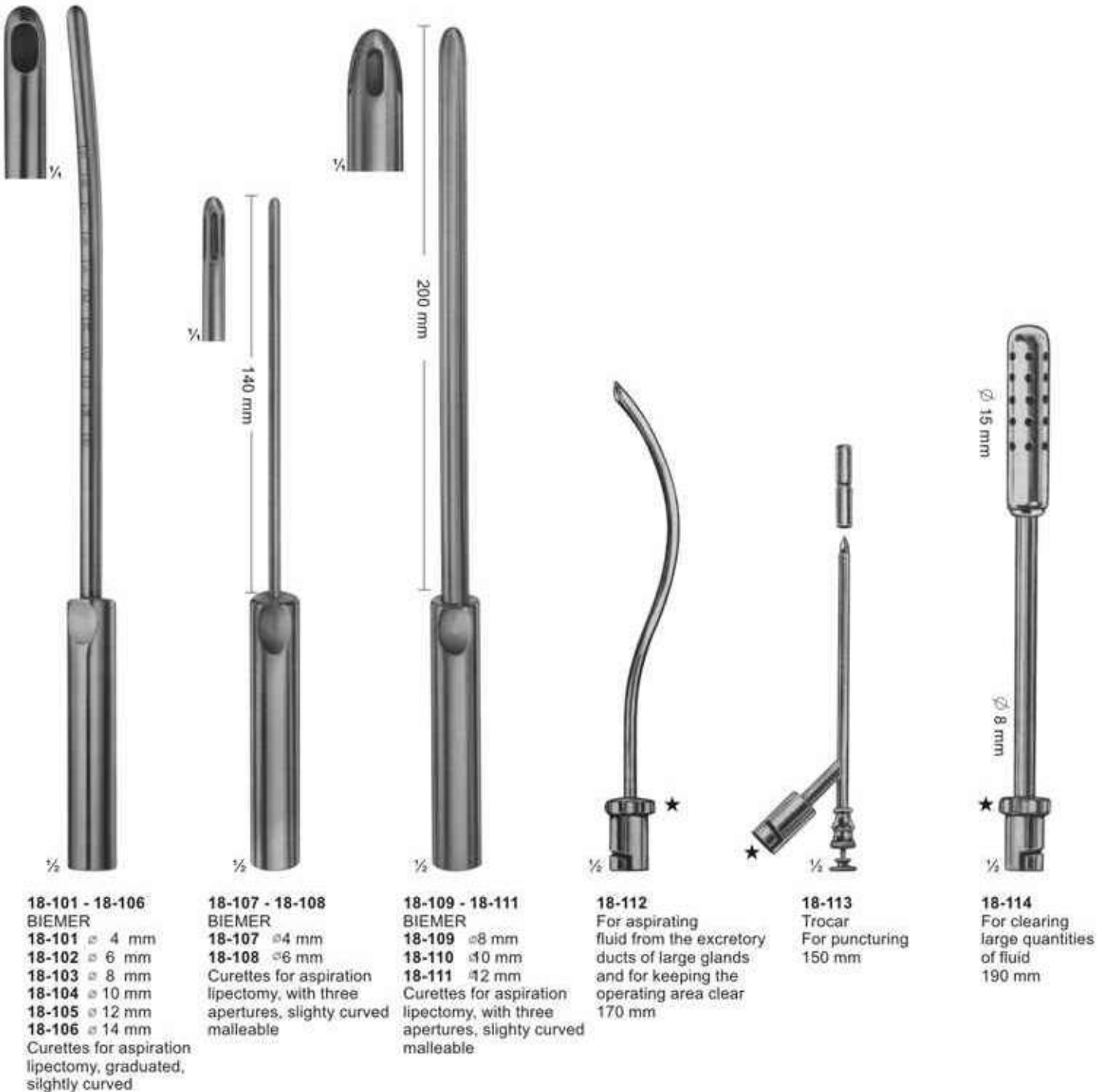

## Suction Instruments

**18-115** 150mm  
Suction handle, with vacuum regulator and finger cut-off, brass, mirror-finish chromium-plated



olive  
Ø 9 mm

**18-116** 170mm  
Suction handle, with hand regulation valve and quick-shutter, brass, mirror-finish chromium-plated



Both suction handles have bayonet fitting olive and can be used for the suction cannulae. Ø 9 mm



**18-117**  
Trocar  
For puncturing  
170 mm



**18-118**  
Hollow needle,  
sharp  
150 mm



**18-119**  
double curved  
For general  
surgery  
230 mm



**18-120**  
For tonsillectomy,  
oral and laryngeal  
operations  
190 mm



**18-121**  
For tonsillectomy,  
oral and laryngeal  
operations  
220 mm

★ With bayonet fitting to be used with suction handles (18-115 - 18-116)

# Suction Instruments

**18-122**  
**WULLSTEIN**  
 Suction tube, conical, silver, olive  
 with LUER hub  
 160 mm



**18-123** 1.5 mm  
**18-124** 2.0 mm  
**WULLSTEIN**  
 Suction tube, cylindrical, silver, with  
 stylet olive with LUER hub  
 160 mm



Usable length

YASARGIL usable length diam.		YASARGIL usable length diam.	
<b>18-125</b>	130 mm 1,5 mm	<b>18-133</b>	130 mm 2,5 mm
<b>18-126</b>	150 mm 1,5 mm	<b>18-134</b>	150 mm 2,5 mm
<b>18-127</b>	180 mm 1,5 mm	<b>18-135</b>	180 mm 2,5 mm
<b>18-128</b>	220 mm 1,5 mm	<b>18-136</b>	220 mm 2,5 mm
<b>18-129</b>	130 mm 2,0 mm	<b>18-137</b>	130 mm 3,5 mm
<b>18-130</b>	150 mm 2,0 mm	<b>18-138</b>	150 mm 3,5 mm
<b>18-131</b>	180 mm 2,0 mm	<b>18-139</b>	180 mm 3,5 mm
<b>18-132</b>	220 mm 2,0 mm	<b>18-140</b>	220 mm 3,5 mm
		<b>18-141</b>	180 mm 4,5 mm

**18-142 - 18-144**  
**LANDOLT**  
 150 MM  
 diam  $\varnothing$  3 mm

**18-142** 8 mm / curved  
**18-143** 11mm / curved  
**18-144** 15mm / curved

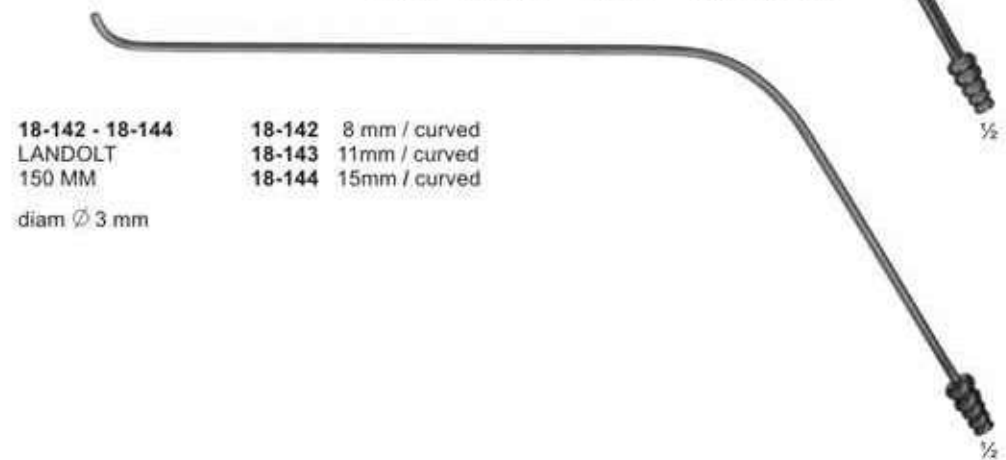

**18-145** 500 mm  
**18-146** 350 mm  
 with rubber tip,  
 with LUER hub

**18-147** 2.0 mm diam  
**18-148** 2.5 mm diam  
**18-149** 3.0 mm diam  
 with finger cut-off,  
 thumb piece 90° to  
 curve, with LUER hub  
 250 mm



# Combined Suction and Irrigation Cannulae, Coagulation Suction Cannulae

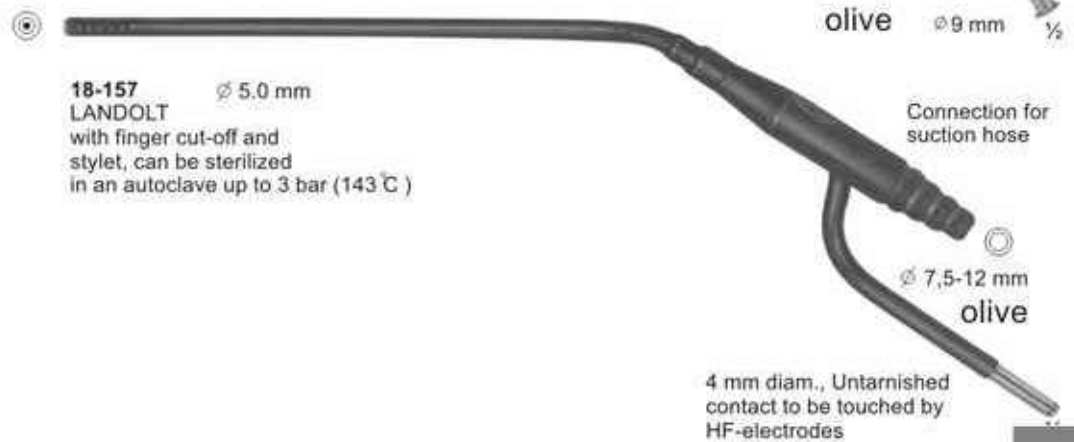

## Suction Instruments

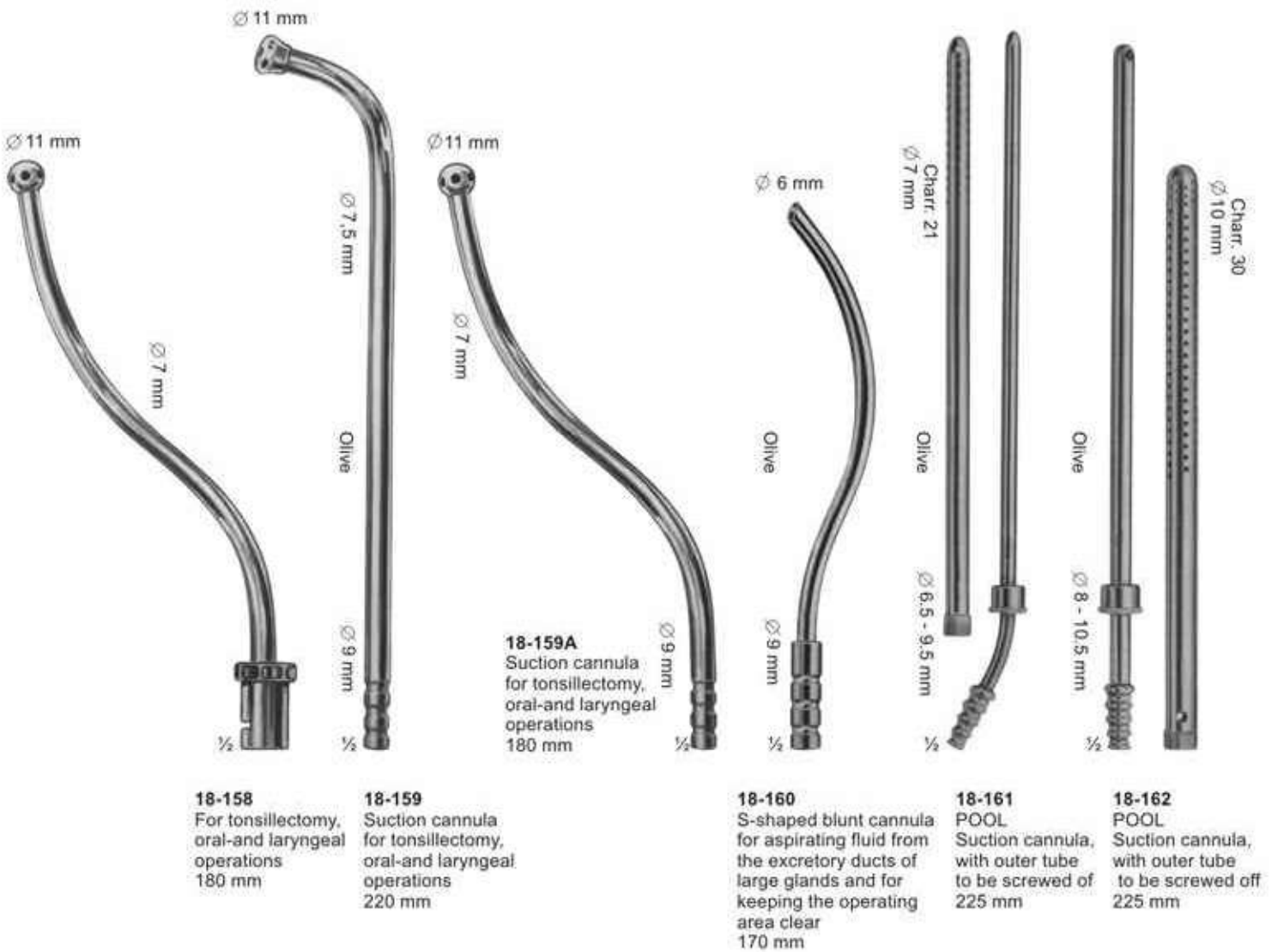

## Suction Instruments

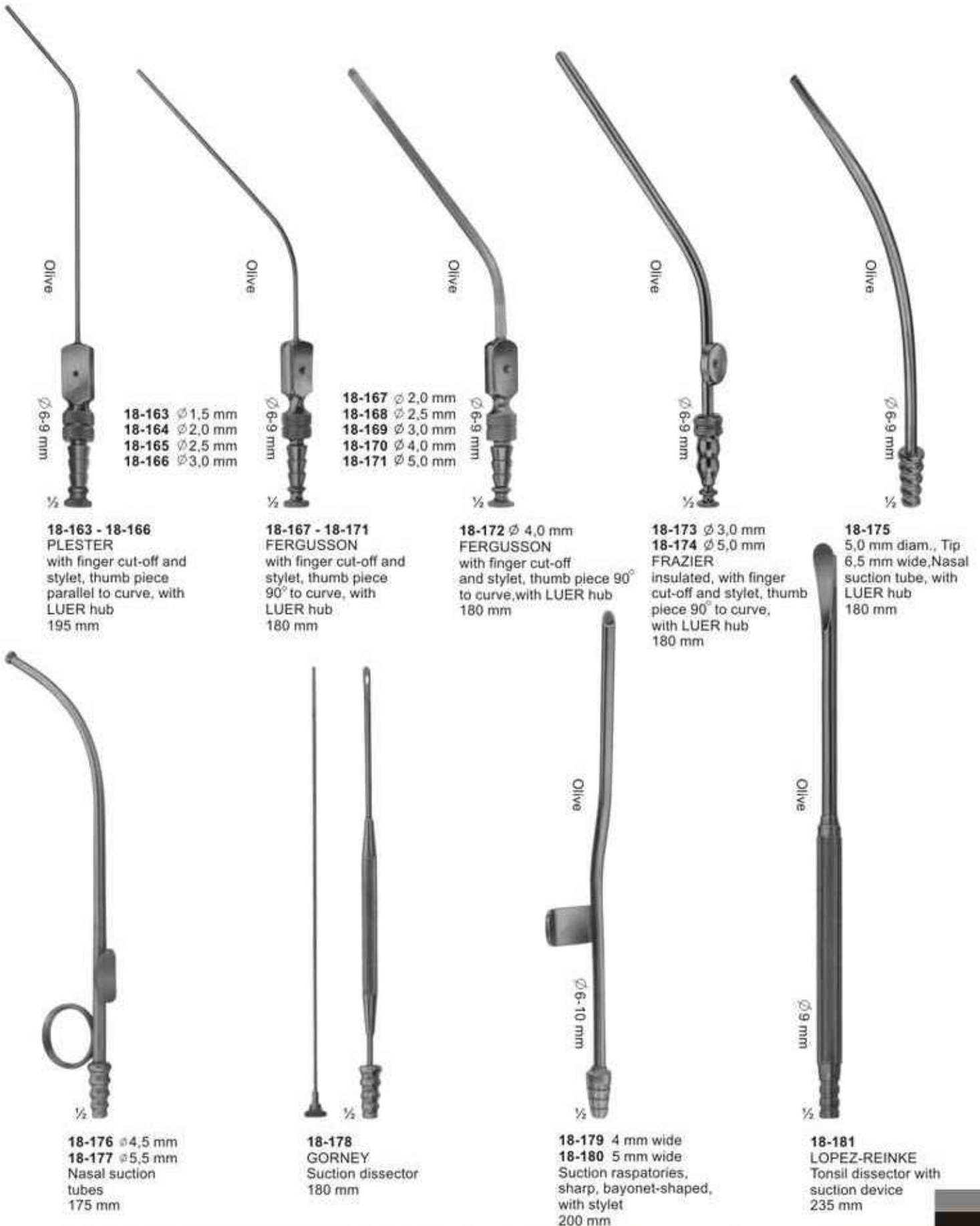

## Dissection Instruments



### 18-182

- 1- Blow pipe .
- 2- 3 PCS .scalpel.
- 3- Dissecting forcep 13 cm.
- 4- Grooved director with tounge tie 13 cm.
- 5- Triple chain hook.
- 6- Dressing scissors probe pointed 13 cm.
- 7- Probe double 13 cm.
- 8- Zipper case inside red velvet.



### 18-183

- 1- Probe Double 13 cm
- 2- 2 PCS, Scalpel S.S
- 3- Grooved Director With tongue Tie 13 cm
- 4- Mayo Hegar Needle Holder 13cm
- 5- Discting Forcep 13 cm 1x2 Teeth
- 6- Dressing Forcep 13 CMS Serrated.
- 7- Dressing Scissor 13 cm S/B STR.
- 8- Dressing Scissor 13 cm S/B CVD.
- 9- Zipper Case Inside Red Velvet.

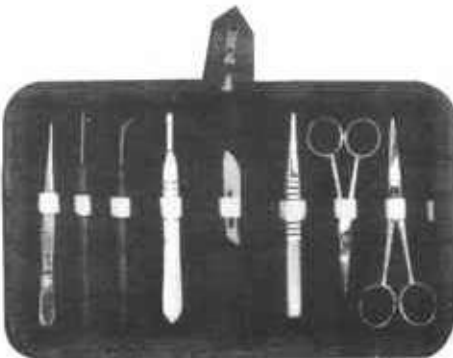

### 18-184

- 1- Dissecting Forcep 11.5 cm Sharp Point.
- 2- Iris Scissor
- 3- B.P Handle No. 4
- 4- Teasing Needle Sharp angular.
- 5- Blade No. 22
- 6- Thumb Forceps T.O.E 13 cm
- 7- Dissecting Scissor STR 11.5 cm
- 8- Dissecting Scissor STR 13 cm
- 9- Zipper case Inside Red Velvet

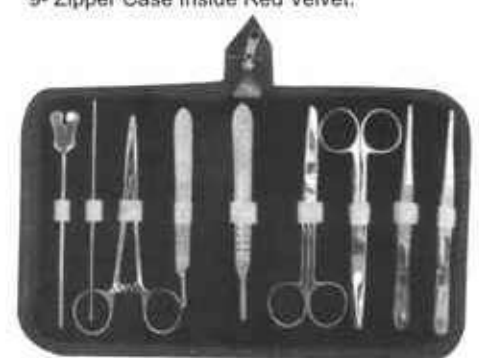

### 18-185

- 1- Grooved Director with Tongue Tie 14 cm
- 2- Probe Double 14cm
- 3- Mayo Hegar Needle Holder 14 cm
- 4- BP. Handle no.3
- 5- BP. Handle no.4
- 6- Dressing Scissor 14 cm S/B STR
- 7- Dressing Scissor 14 cm S/B CVD.
- 8- Dressing Forcep 1x2 Teeth 14 cm
- 9- Dressing Forcep Serrated 14 cm



### 18-186

- 1- Probe double 12.5 cm
- 2- Scalpel
- 3- B.P Handle No. 4
- 4- 6 PCS Blade 2 each no. 21, 22, 23
- 5- Dissecting Forcep 12.5 cm
- 6- Dissecting Forcep 11.5 cm sharp Point
- 7- Dissecting Scissor S/B STR 13 cm
- 8- Dissecting Scissor S/S STR 13 cm



### 18-187

- 1- Teasing Needle with Chuck CVD.
- 2- Huber Probe
- 3- Iris Scissor
- 4- Dissecting Forcep Fine 14 cm.
- 5- Dissecting Forcep Fine CVD. 12 cm
- 6- Operating Scissor with Probe 14 cm.
- 7- B.P. Handle no. 4



## Dissection Instruments



### 18-188

- 1- Probe with eye
- 2- Dissecting Forcep cvd fine 12 cm.
- 3- Iris Scissor
- 4- Operating Scissor S/B str 14 cm
- 5- Grooved Director and Tongue tie
- 6- Huber Probe
- 7- Triple Chain Hook
- 8- B.P Handle No. 4
- 9- B,P Handle No. 3
- 10- Teasing Needle with Chuck cvd.
- 11- Teasing Needle with Chuck str.
- 12- Dissecting Forceps Fine 14 cm.



### 18-190

- 1- Iris Scissor STR
- 2- Dissecting Forceps CVD 12 cm.
- 3- Scalpel
- 4- Teasing Needle STR wooden handle.
- 5- Teasing Needle CVD wooden handle.
- 6- Watchmaker fine point.



### 18-192

- 1- Probe double end.
- 2- Grooved director and tounge tie.
- 3- B.P handle no.4
- 4- Operating scissor STR S/b14cm.
- 5- Kelly forceps STR 14cm.
- 6- Dissecting forceps thumb 13cm.

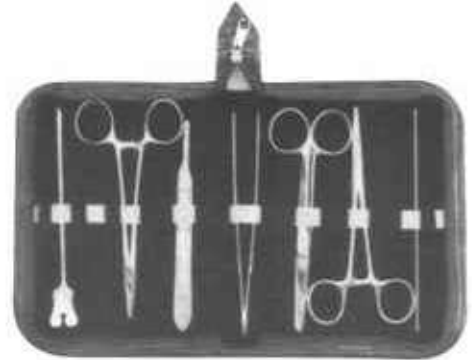

### 18-189

- 1- Grooved Director and Tongue tie
- 2- Mayo Hearn Needle Holder 14 cm
- 3- B.P Handle No. 4
- 4- Dissecting Forceps Thump 14 cm.
- 5- Operating Scissor S/B str 14 cm
- 6- Kelly Forcep STR 14 cm.
- 7- Probe Double end



### 18-191

- 1- Probe Double end
- 2- B.P Handle No. 4
- 3- Dissecting Forcep 1x2 Teeth 14 cm.
- 4- Operating Scissor S/B str 14 cm
- 5- Mayo Hearn Needle Holder 14 cm
- 6- Kelly Forcep STR 14 cm.
- 7- Operating Scissor S/B CVD 14 cm
- 8- Grooved Director and Tongue tie
- 9- Dissecting Forceps Thumb 14 cm.



### 18-193

- 1- Dissecting Forceps Thumb 14 cm
- 2- Dissecting Forcep 1x2 Teeth 14 cm.
- 3- B.P Handle No. 3
- 4- Grooved Director and Tongue tie
- 5- Mayo Hearn Needle Holder 14 cm
- 6- Operating Scissor S/B str 14 cm
- 7- Probe Double end
- 8- Kelly Forcep STR 14 cm.

## Dissection Instruments



### 18-194

- 1- Dissecting Forcep Fine 14cm.
- 2- Dissecting Forcep Fine CVD 12cm
- 3- Dissecting Forcep with Pin 14cm.
- 4- Watchmaker Fine point
- 5- Iris scissor STR
- 6- Iris scissor CVD.
- 7- Teasing Needle holder
- 8- Teasing Needle STR.
- 9- B.P. Handle no. 3



### 18-195

- 1- Teasing Needle STR.
- 2- Grooved Director and Tongue Tie.
- 3- Teasing Needle CVD.
- 4- Dissecting Forcep with Pin 12 cm Fine
- 5- Operating Scissor S/B STR 14 cm
- 6- Triple Chain Hook
- 7- Probe with eye
- 8- Probe Double end
- 9- Probe and Hook
- 10- Dissecting Forcep Fine 14 cm
- 11- Iris Scissor
- 12- Huber Probe
- 13- B.P. Handle no.3
- 14- B.P. Handle no.4



### 18-196

- 1- Dissecting forcep fine STR with pin 12cm.
- 2- Iris scissor STR.
- 3- Probe with eye.
- 4- Probe and hook.
- 5- Operating scissor S/B STR 14cm
- 6- Triple chain hook.
- 7- B.P. handle no.4
- 8- Humber probe.
- 9- B.P.handle no.3
- 10- Teasing needle STR. plastic handle.
- 11- Teasing needle CVD plastic handle.
- 12- Grooved director and tongue tie.
- 13- Probe double end.



### 18-197

- 1- Dissecting Forceps Thumb 14 cm.
- 2- Dissecting Forcep 1x2 Teeth 14 cm.
- 3- B.P Handle No. 3
- 4- Grooved Director and Tongue tie
- 5- Mayo Hearn Needle Holder 14 cm
- 6- Operating Scissor S/B str 14 cm
- 7- Probe Double end
- 7- Kelly Forcep STR 14 cm.

## Hospital Wares



**19-101 - 115**  
 Schimmelbusch

	∅ x H sizes in mm
<b>19-101</b>	80 x 80
<b>19-102</b>	105 x 120
<b>19-103</b>	140 x 140
<b>19-104</b>	160 x 120
<b>19-105</b>	160 x 150
<b>19-106</b>	190 x 150
<b>19-107</b>	190 x 190
<b>19-108</b>	240 x 160
<b>19-109</b>	240 x 240
<b>19-110</b>	290 x 160
<b>19-111</b>	290 x 240
<b>19-112</b>	340 x 160
<b>19-113</b>	340 x 340
<b>19-114</b>	390 x 190
<b>19-115</b>	390 x 290



**19-116**  
 Box  
 120 x 65 x 13mm  
 (without Bulldog clamps,  
 without silicone tape)



**19-117**  
 Box with support  
 120 x 65 x 13 mm  
 (ohne Bulldogklemmen)



**19-118**  
 Box with support for  
 needle electrodes,  
 without instruments



**19-119 - 121**  
 50 x 25 x 4,5 mm  
**19-120**  
 65 x 42 x 8 mm  
**19-121**  
 75 x 25 x 4,5 mm



**19-122**  
 ∅ 65mm x 15mm

## Hospital Wares



19-123 - 131

	∅ x H
19-123	30 x 90 mm
19-124	50 x 100 mm
19-125	50 x 130 mm
19-126	50 x 175 mm
19-127	75 x 100 mm
19-128	75 x 130 mm
19-129	75 x 175 mm
19-130	100 x 175 mm
19-131	100 x 200 mm



19-141 - 142

- 19-141** Martin Sterilizing Forceps consisting of:  
1 Sterilizing Forceps, curved, 25 cm, without ratchet, with lid for jar  
1 jar with bottom plate (anti-tilt)
- 19-142** ditto, with 32 cm long Sterilizing Forceps



19-132 - 139

19-132	165 x 85 x 35 mm
19-133	200 x 100 x 35 mm
19-134	200 x 100 x 50 mm
19-135	230 x 130 x 50 mm
19-136	260 x 150 x 50 mm
19-137	270 x 235 x 50 mm
19-138	300 x 200 x 50 mm
19-139	325 x 275 x 50 mm



19-140  
205 x 105 x 35 mm

## Round Metal Boxes and Medicine Cups



19-143 - 148

	∅ x H
19-143	75 x 60 mm
19-144	75 x 75 mm
19-145	100 x 60 mm
19-146	100 x 100 mm
19-146A	125 x 80 mm
19-147	125 x 125 mm
19-148	150 x 150 mm



19-149  
25 cc

19-150  
50 cc



19-151  
20 cc  
Medicine Spoon



19-152  
∅ 75 x 12 mm  
Tablet Tray



19-153  
∅ 90 x 90 mm  
Metal Cup



19-154  
∅ 75 x 80 mm  
Sputum Cup



Kidney Dish



19-155 - 157

19-155	170 x 100 x 35 mm
19-156	250 x 140 x 40 mm
19-157	275 x 150 x 45 mm

## Hospital Wares



19-158 - 165



19-166 - 170

	Ø x H		
19-158	40 x 19 mm	0.05L	
19-159	61 x 30 mm	0.07L	
19-160	80 x 40 mm	0.14L	
19-161	116 x 50 mm	0.35L	
19-162	128 x 55 mm	0.45L	
19-163	147 x 65 mm	0.70L	
19-164	167 x 75 mm	1.10L	
19-165	187 x 85 mm	1.60L	

19-166	116 x 35 mm	0.30L
19-167	128 x 38 mm	0.40L
19-168	147 x 40 mm	0.50L
19-169	157 x 45 mm	0.75L
19-170	187 x 45 mm	1.00L



19-171  
Ø 110 x 28 mm 0.15L



19-172  
100 cc 0.1L



19-173 - 176  
19-173 0.25L  
19-174 0.50L  
19-175 1.00L  
19-176 2.00L



19-177  
235 x 190 x 40 mm



19-178  
Ø 220 x 70 mm

## Hospital Wares



**19-179**  
∅ 50 x 100 mm  
Powder Pot



**19-180**  
∅ 50 x 75 mm  
Methot With Lid



**19-181**  
∅ 50 x 75 mm  
Methot Without Lid



**19-182**



**19-183**



**19-184**



**19-185 - 186**

**19-185** ∅ 235 mm  
**19-186** ∅ 310 mm

## Needle Cases



**19-187**  
Sauerbruch  
210 x 125 x 17 mm



**19-188**  
Sauerbruch  
210 x 125 x 17 mm



**19-189**  
150 x 95 x 13 mm



**19-190**  
150 x 95 x 13 mm



**19-191**  
150 x 95 x 13 mm



**19-192**  
150 x 95 x 13 mm



**19-193**  
150 x 95 x 13 mm



**19-194**  
150 x 95 x 13 mm



**19-195**  
150 x 95 x 11 mm



## Storing Cases



19-199 - 209

19-199	230 x 130 x 50	mm
19-200	260 x 150 x 50	mm
19-201	275 x 235 x 50	mm
19-202	300 x 200 x 50	mm
19-203	325 x 275 x 50	mm
19-204	420 x 175 x 50	mm
19-205	230 x 130 x 75	mm
19-206	260 x 150 x 75	mm
19-207	300 x 200 x 75	mm
19-208	325 x 275 x 75	mm
19-209	420 x 175 x 75	mm



**19-196**  
Deponette  
245 x 135 x 35mm



**19-197**  
Deponette  
245 x 135 x 50mm



**19-198**  
Deponette  
245 x 135 x 60mm

## Sterilizing Baskets / Trays



19-210 - 212

19-210	480 x 250 x 50	mm
19-211	520 x 250 x 75	mm
19-212	520 x 250 x 100	mm

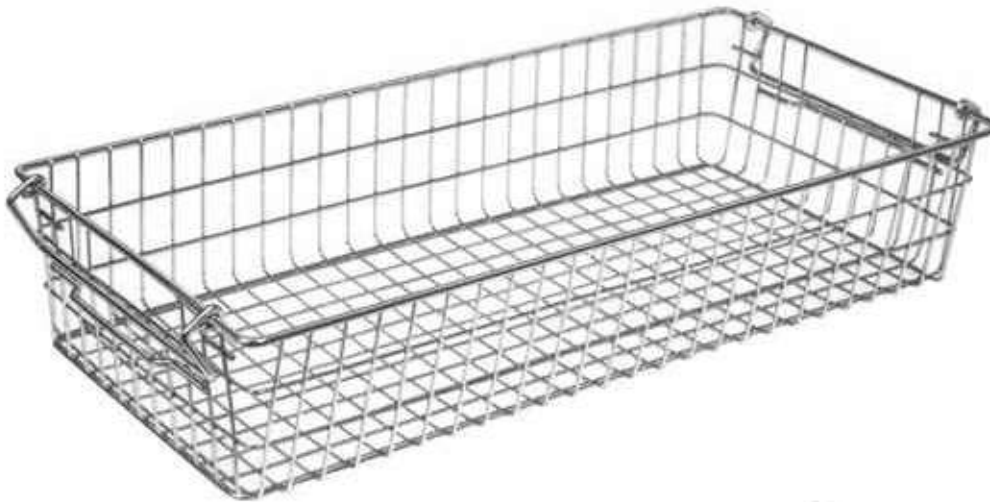

19-219  
 (60 x 30 x 15 cm)  
 Nominal dimensions



19-213 - 218

19-213	240 x 240 x 50	mm
19-214	240 x 240 x 80	mm
19-215	240 x 240 x 100	mm
19-216	480 x 260 x 50	mm
19-217	520 x 260 x 80	mm
19-218	520 x 260 x 100	mm

## Scissors with Tungsten Carbide Inserts



**26-101**  
Standard

14,5cm  
16,5cm  
18,5cm



**26-102**  
Standard

14,5cm  
16,5cm  
18,5cm



**26-103**  
Standard

14,5cm  
16,5cm  
18,5cm



**26-104**  
Standard

14,5cm  
16,5cm  
18,5cm



**26-105**  
Standard

14,5cm  
16,5cm  
18,5cm



**26-106**  
Standard

14,5cm  
16,5cm  
18,5cm

## Scissors with Tungsten Carbide Inserts

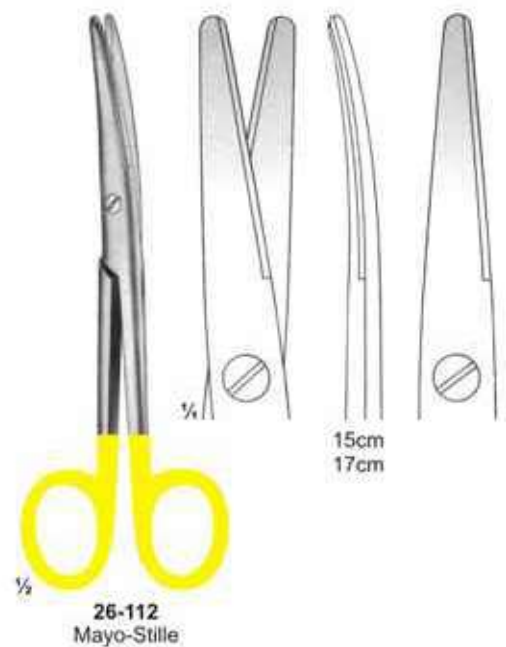
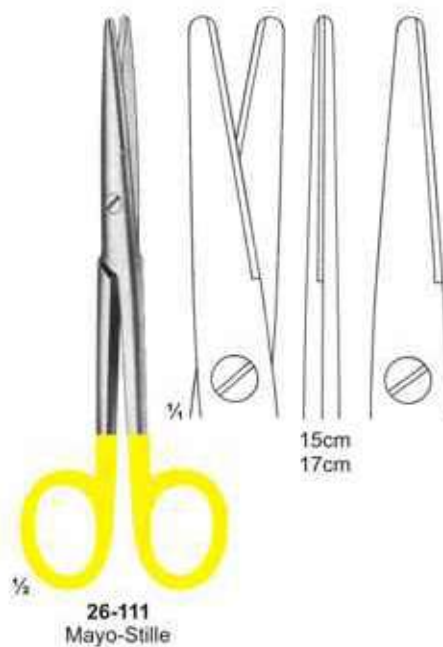
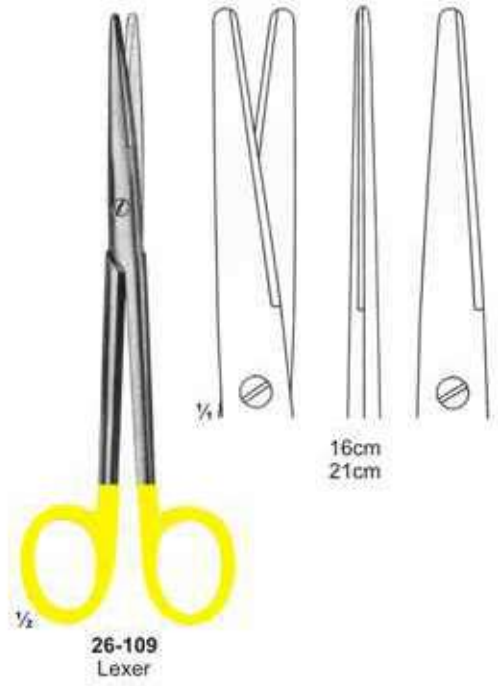
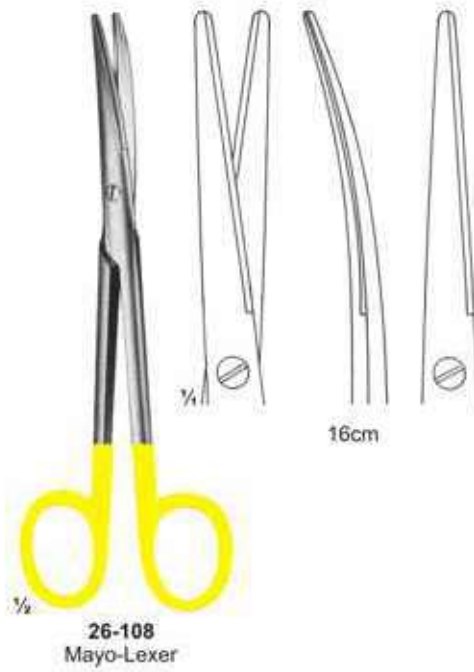

## Scissors with Tungsten Carbide Inserts

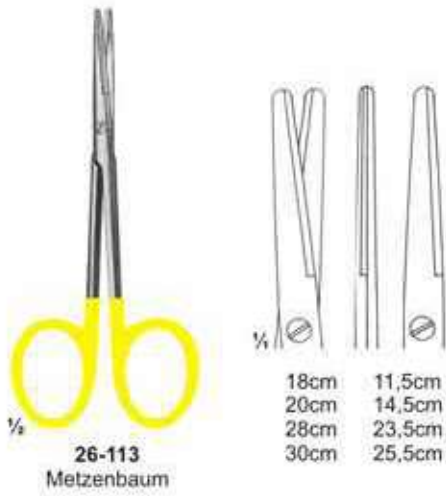

## Scissors with Tungsten Carbide Inserts

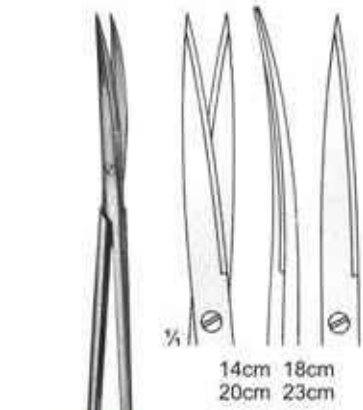

1/2  
**26-119**  
Metzenbaum-Fino

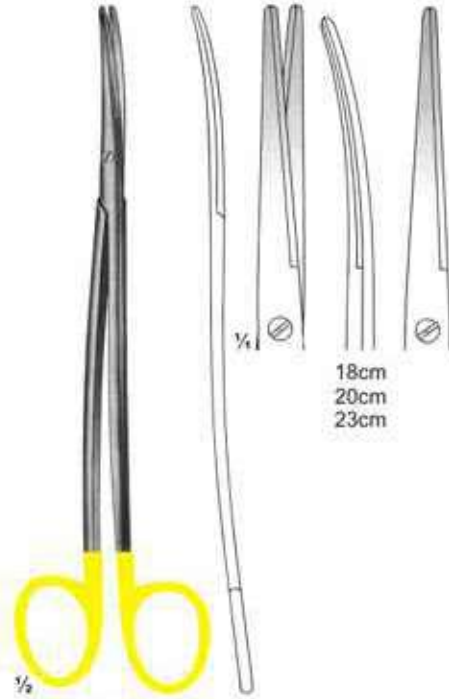

1/2  
**26-120**  
Metzenbaum-Fino

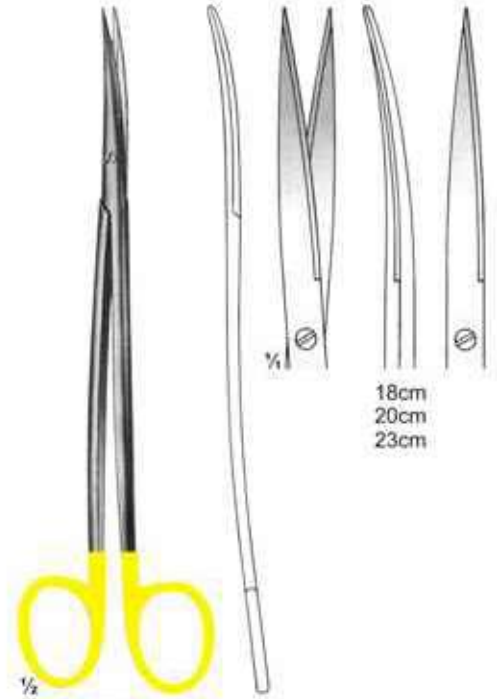

1/2  
**26-121**  
Metzenbaum-Fino

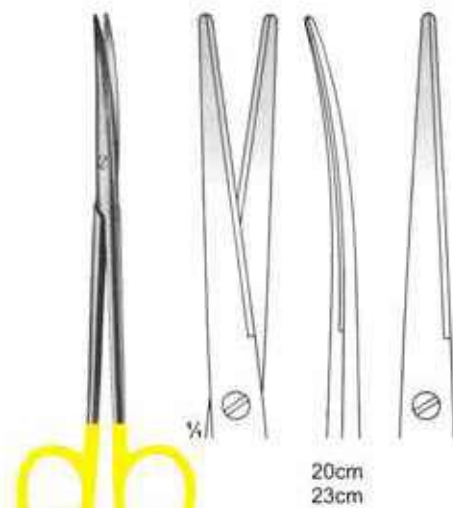

1/2  
**26-122**  
Metzenbaum



1/2  
**26-123**  
Mayo

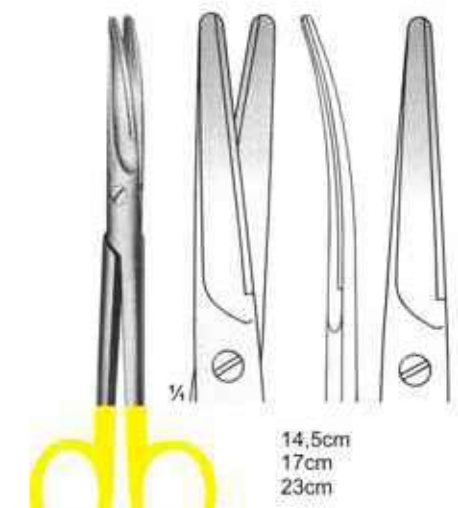

1/2  
**26-124**  
Mayo

## Scissors with Tungsten Carbide Inserts

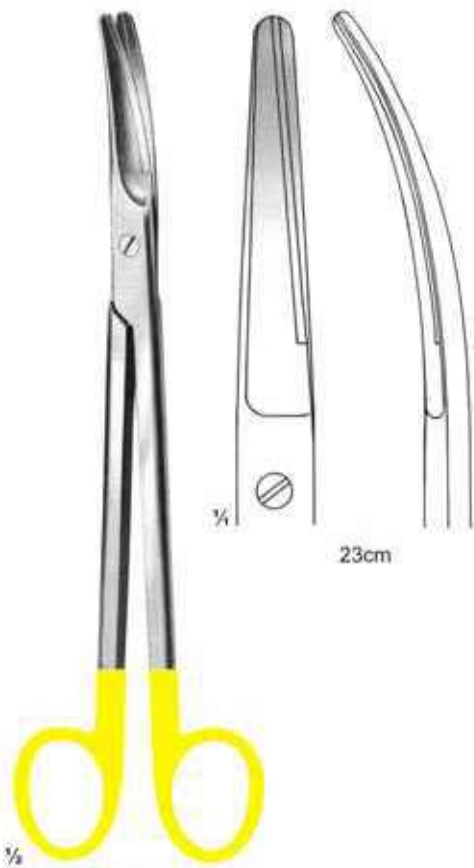

26-125  
Parametrium

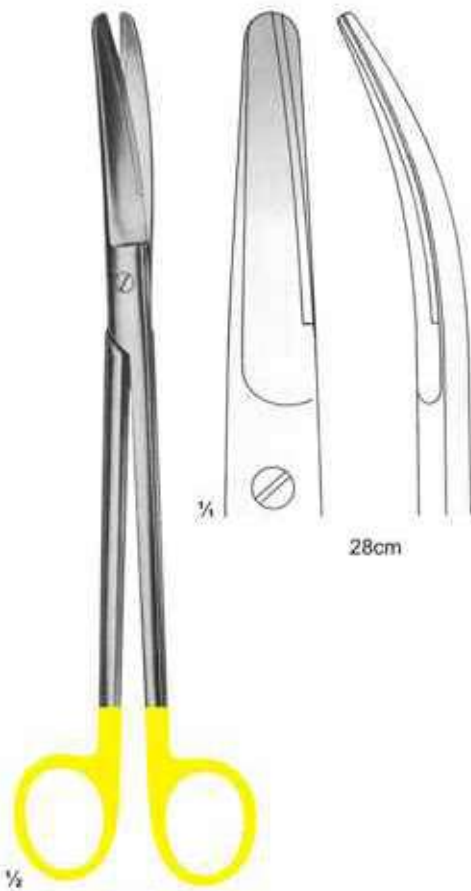

26-126  
Mayo-Harrington

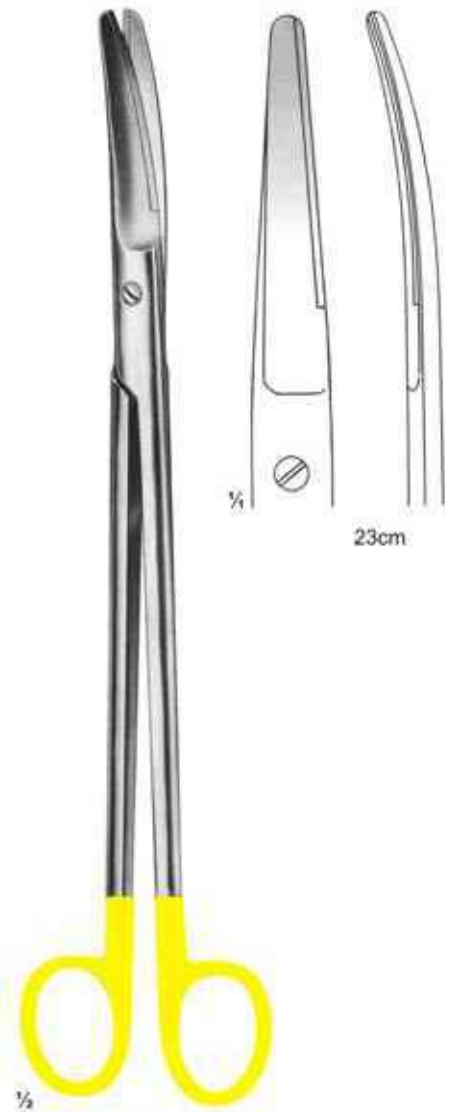

26-127  
Sims

## Scissors with Tungsten Carbide Inserts

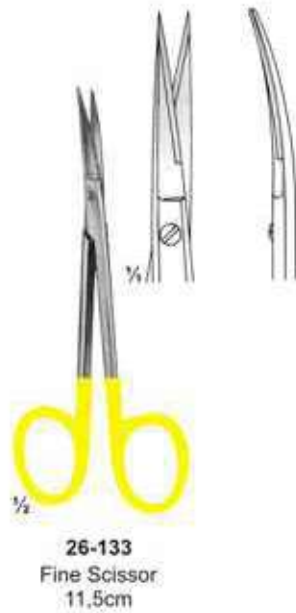
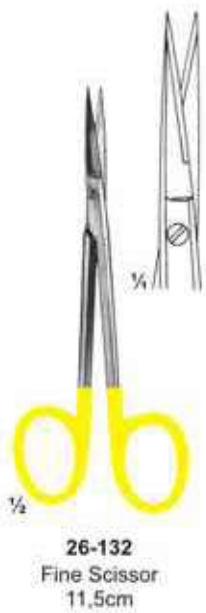



## Scissors with Tungsten Carbide Inserts

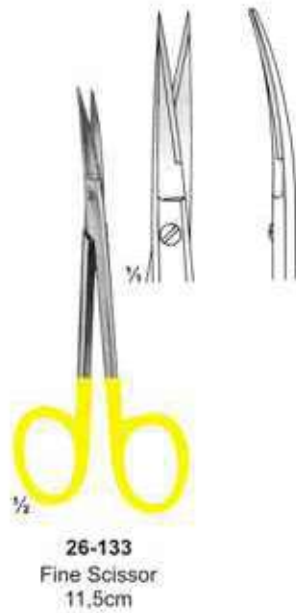
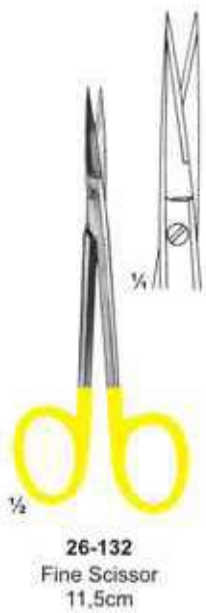

# Scissors & Dissecting Forceps with Tungsten Carbide Inserts



**26-136**  
Universal  
12cm



**26-137**  
Ligature Scissors  
1 Black & 1 Goldplated ring

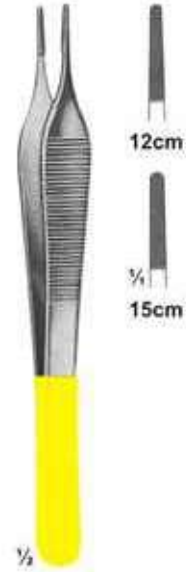

**26-138**  
Adson



**26-139**  
Cushing  
17,5cm



**26-140**  
Cushing  
18cm



**26-141**  
Cushing-Taylor  
18cm



**26-142**  
Dissecting Forceps  
15cm



**26-143**  
Semken  
15cm

## Dissecting Forceps and Needle holders with

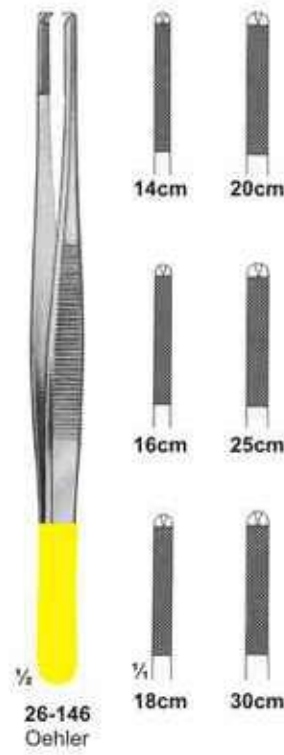
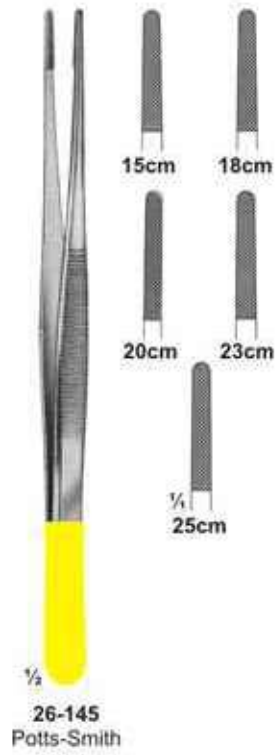

## Dissecting Forceps and Needle holders with

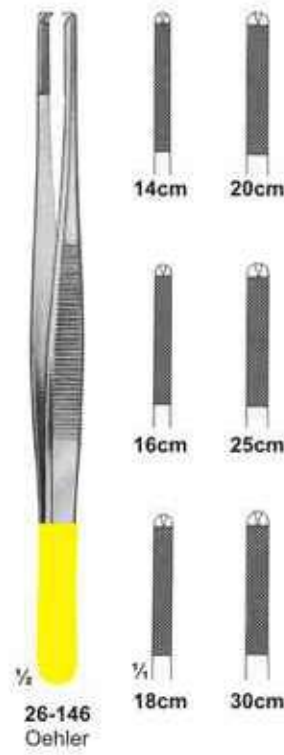
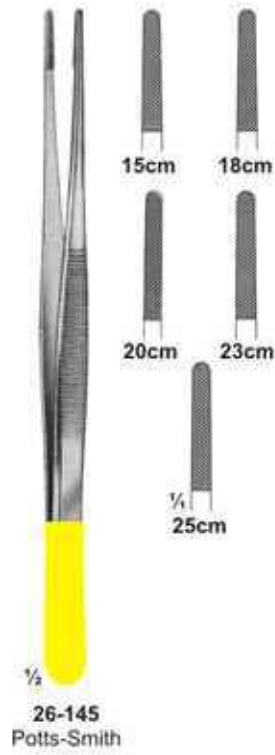

## Needle holders with Tungsten Carbide Inserts



26-152  
Arruga  
16cm



26-153  
Castroviejo  
13cm



26-154  
Hegar  
20cm 24cm

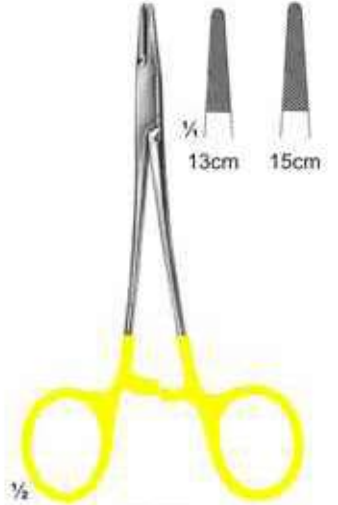

26-155  
Halsey  
13cm 15cm



26-156  
Mayo-Hegar  
16cm 18cm 20cm  
24cm 26cm 30cm



26-157  
De-Bakey  
18cm 20cm 23cm  
26cm 31cm 37cm

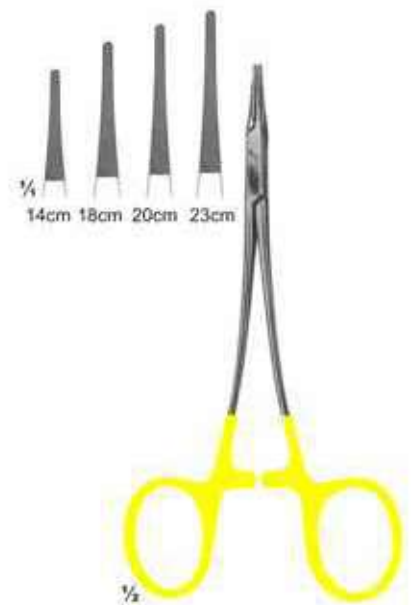

26-158  
Hegar-Vascular  
14cm 18cm  
20cm 23cm

## Needle holders with Tungsten Carbide Inserts



26-159  
Bozemann-Wertheim  
20cm 24cm 26cm



26-160  
Stratte  
22cm 23cm

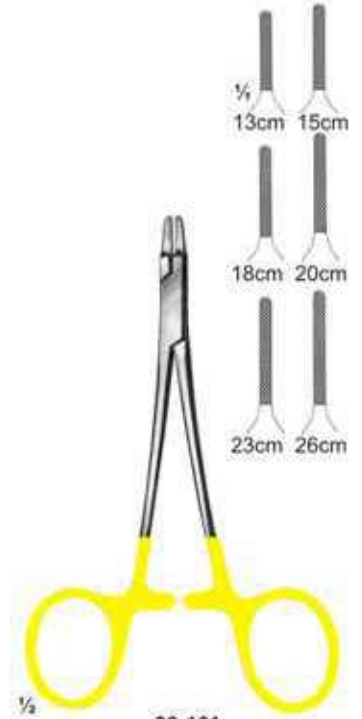

26-161  
Ryder  
13cm 15cm 18cm  
20cm 23cm 26cm



26-162  
Ryder-Vascular  
13cm 15cm 18cm  
20cm 23cm 26cm



26-163  
Martin  
15cm 17cm 20cm



26-164  
Sarot  
18cm 20cm 26cm

## Needle holders with Tungsten Carbide Inserts



## Needle holders with Tungsten Carbide Inserts



26-172  
Mathieu-Ryder  
17cm  
20cm 24cm



26-173  
Lichtenberg  
20cm



26-174  
Langhals  
20cm 25cm



26-175  
Lichtenberg  
20cm 25cm



26-176  
Luehty-Beck  
20cm 25cm



26-177  
Luehty-Beck  
20cm 25cm



26-178  
Langebeck  
18cm  
20cm 23cm



26-179  
Langebeck-beck  
18cm  
20cm 23cm



## Wire Cutting Plier With T.C. Inserts



**26-180**  
**TOENNIS**  
Elastic pattern for  
dura-or intestinal suture  
180 mm



**26-181**  
**Cutting Plier**  
12 cm

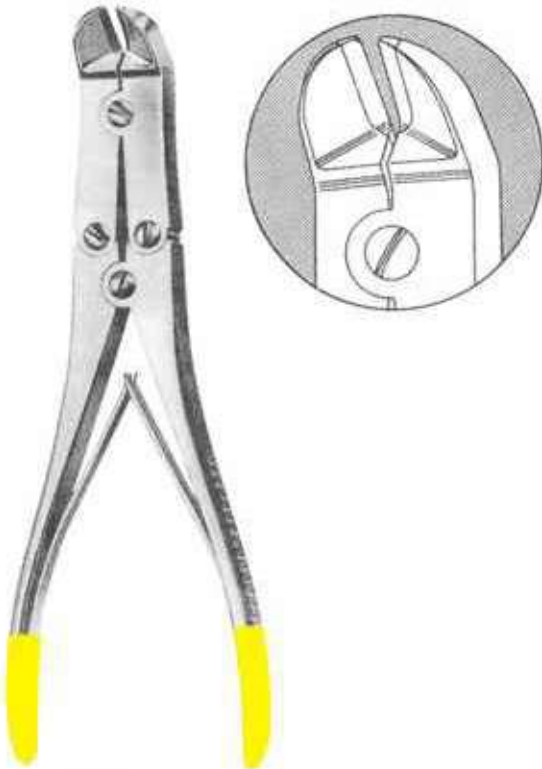

**26-182**  
**MULLAR CLAUS**  
22 cm



**26-183**  
**Plier**  
17.5 cm

# Alphabetical Index

<b>A</b>	
ABRAHAM, tonsil knife	13
ADSON, forceps	33
ADSON, forceps	37
ALLIS, artery traction forceps	47
ALLIS, intestinal grasping forceps	86
ALY, aesthesiometer	01
AMPUTATING KNIVES	12
ANDREW, tongue depressor	04
ANESTOPHON, stethoscope	02
ARRUGA, forceps	37
ARRUGA, needle holder	61
ASCH, biopsy curettes	112
AUFRIEHT, rasps	138
AYRE, cone knife, 235mm	13
ADSON - BROWN, Tissue Forceps	39
ADSON, Haemostatic Forceps	52
ANGLE, Wire Cutters Cutting Scissors	151
<b>B</b>	
BABCOCK, intestinal grasping forceps	86
BABY-ALLIS, artery traction forceps	47
BACKHAUS, towel clamps	48
BACKHAUS-KOCHER, towel clamps	48
BAILEY, rib spreaders	128
BAKES, gall duct dilators	95
BALFOUR, abdominal retractors	85
BALFOUR-BABY, abdominal retractors	84
BANE-HARTMANN, bone rongeurs	144
BARTH, bone curettes	139
BABY-MOSQUITO, Haemostatic Forceps	51
BABY-ROUX, Retractors	73
BABY-SENN-MILLER, Retractors	73
BEEBE wire scissor	29
BEER, cilia forceps	42
BENGOLEA, delicate forceps	50
BERGER, biopsy forceps	115
BERLINER, percussion hammer	01
BENDING PLIERS, Wire Holding forceps	150
BERTILLON, Examination & Measuring Instruments	10
BIEMER, vein scissor	16
BISHOP-HARMON, forceps	37
BIEMER, Suction Instruments	158
BLAKE, gall stone forceps	96
BLUMENTHAL, bone rongeurs	144
BONNEY, tissue forceps	41
BOSE, tracheal hooks	119
BOWLES, stethoscope	02
BOYS-ALLIS, artery traction forceps	47
BOZEMANN, dressing forceps	108
BOYNTON, Needle Holders	47
BRAUN, artery traction forceps	107
BRAUN, uterine probes	28
BRAUN-STADLER episiotomy scissor	31
BRAUN-STADLER, bandage scissors	102
BRIESKY, vaginal specula	66
BRODIE, probes	34
BROPHY, dissecting forceps	04
BRUENINGS, tongue depressor	13
BRUNINGS, tonsil knife, 215mm	76
BRUNNER, retractors	126
BRUNNER, rib shears	31
<b>C</b>	
BRUNS, plaster scissor	64
BRYANT, sponge forceps	43
BROPHY, Tissue Forceps	38
BROWN, Tissue Forceps	39
BUCHS, retractors	75
BUCHWALD, tongue depressor	04
BUCK, neurological hammer	01
BUMM, ovum forceps	230
BUCK, Ear Curettes	110
CASPAR, retractor	75
CASPAR, Micro scissor 115mm	16
CASTROVIEJO, tissue forceps	37
CASTROVIEJO, micro spring scissor	15
CASTROVIEJO, needle holder	61
CASTROVIEJO, eye scissor 110mm	15
CASTROVIEJO, eye scissor 115mm	15
CATLIN, amputating knife 160mm	12
CALIPER, Examination & Measuring Instruments	10
CARREL, Haemostatic Forceps	51
CARROLL, Examination & Measuring Instruments	10
CASPAR, Rongeurs	133
CASPAR, Rongeurs	134
CASTROVIEJO, Examination & Measuring Instruments	10
CHAPUT, artery traction forceps	47
CLOWARD, lamina Spreaders	83
CLAUS PLIER, Wire Cutting Plier With T.C. Inserts	187
CLAUS PLIER, Wire Cutting Plier With T.C. Inserts	187
COAKLEY, antrum trocars	100
COLLIN, intestinal grasping forceps	86
COLLIN, rib shears	126
COLLIN, sponge and dressing forceps	44
COLLIN, tongue forceps	05
COLLIN, vaginal spatula	101
CONE KNIFE 235mm11	13
CONVERSE, fine wound retractor	69
COOLEY, multi purpose clamps	122
COTTLE, retractors	71
COTTLE, nasal scissor	25
COTTLE, fine wound retractor	69
COTTLE, mallets	140
COLLIN, Examination & Measuring Instruments	10
COLLIN, Intestinal Grasping Forceps	46
COLLIN, Retractors	73
COLLIN-HARTMANN, Retractors	73
COTTLE, Forceps, Bayonet - Shaped	40
COTTLE, Nasal Specula	91
CRILE, Haemostatic Forceps	52
CRILE, Haemostatic Forceps	52
CRILE, Retractors	73
CUTTING PLIER, Wire Cutting Plier With T.C. Inserts	187
CRAFOORD, haemostatic forceps	50
CRILE, needle holder	63
CUSCO, vaginal specula	101
CUSHING, wound and vein retractor	71
CUSHING, dissecting forceps	34
CUSHING-KOCHER, retractors	71
CZERNY, gall stone forceps	96
CZERNY, retractors	72

# Alphabetical Index

<b>D</b>		<b>F</b>	
DAVIDSON, scapula retractors	77	FARABEUF, Retractors	73
DAVIS, vascular spatulas	120	FEILCHENELD, splinter forceps	42
DANDY, Haemostatic Forceps	51	FERGUSSON, haemorrhoidal forceps	93
DE BAKEY, forceps	36	FERGUSSON, suction instrument	163
DE BAKEY, anastomosis clamps	89	FERGUSSON-ACKLAND, mouth gag	05
DE BAKEY, anastomosis clamps	125	FINOCHIETTO, forceps	58
DE BAKEY, arteriotomy scissor	22	FINOCHIETTO, rib spreader	127
DE BAKEY, vana cava clamps	123	FINSEN, tracheal hooks	119
DE BAKEY, multi purpose clamps	122	FIBER OPTIC, laryngoscopes	09
DE BAKEY, retractors	82	FINGER NAIL DRIL, Finger Nail Instruments	155
DE BAKEY, atraumata	121	FINGER RING SAW, Finger Nail Instruments	155
DEAN, nasal and tonsil scissor	25	FINSTERER, Suction Instruments	161
DEAVER, retractors	77	FLAT-NOSED PLIERS, Wire Holding forceps	150
DEAVER, surgical scissor (flat lock)	21	FOERSTER-BALLENGER, Tissue Grasping Forceps	45
DE-BAKEY, bulldog clamps	49	FORCEPS, Finger Nail Instruments	155
DEJERINE, percussion hammer	01	FOREGGER, laryngoscopes	09
DELICATE DISSECTING FORCEPS	33	FOMON, nasal scissor	19
DELICATE SCISSORS, blunt points	19	FORD-BOWLES, stethoscope	02
DELICATE SCISSORS, sharp points	18	FOWLER, tonsil knife	13
DELICATE SCISSORS, sharp points	19	FRANCKE, blood lancet	06
DENHARDT, mouth gag	05	FRAZIER, fine wound retractor	69
DENIS-BROWENE, intestinal forceps	41	FRAZIER, suction instruments	163
DERRA, multi purpose clamps	122	FREER, fine wound retractor	69
DESCHAMPS, ligature needles	65	FREER, vascular spatulas	120
DESJARDINS, gall duct forceps	95	FRENZEL, tongue depressor	04
DESJARDINS, gall stone forceps	96	FRICKE, haemostatic forceps	56
DESJARDINS, gall stone scoops	95	FRITSCH, retractor	79
DESMARRES, wound and vein retractors	71		
DEMEL, Cerclage Instruments	148	<b>G</b>	
DIAGNOSTIC SETS	07	GALLAHER, rasp	126
DICK, vaginal clamps and compression forceps	59	GELPI, special retractors	82
DIEFFEBACH, bulldog clamps	49	GELPI, vaginal retractors	105
DINGMANN, bone holding forceps	142	GERALD, dissecting forceps	34
DISSECTING KNIVES	11	GIERTZ-STILLE, rib shears	126
Dissection Instruments	164	GILL, tissue forceps	37
Dissection Instruments	165	GILL-HESS, tissue forceps	37
Dissection Instruments	166	GILLIES, fine wound retractor	69
DITTEL, metal bougies	80	GILLIES, needle holder	63
DOYEN, abdominal retractors	79	GLOVER, bulldog clamp	49
DOYEN, intestinal clamps	87	GLUCK, rib shears	126
DOYEN, ovum forceps	230	GOOD, tonsil scissors	25
DOYEN, probes	66	GORNEY, suction instruments	163
DOYEN, towel clamps	48	GOSSET, abdominal retractors	84
DOYEN, vaginal specula	104	GRAEFE, fine wound retractor	69
DUROGRIP, Wire Holding forceps	149	GRAVE, vaginal specula	102
DUROTIP, Cutting Pliers	152	GROSS, dressing forceps	43
DUROTIP, Cutting Pliers	153	GUEDEL-NEGUS, laryngoscope	08
DUROTIP, Wire Cutters Cutting Scissors	151	GUTHRIE, fine wound retractor	69
DUVAL-COLLIN, Intestinal Grasping Forceps	46	GUYON, kidney clamps	97
DUPLAY, sponge and dressing forceps	43	GERALD, Tissue Forceps	38
DUVAL, intestinal forceps	41	GILLIES, Tissue Forceps	38
		GOLDSMITH, Nasal Specula	91
<b>E</b>		GRAEFE, Tissue Forceps	39
EISELSBERD, needle holder	63	GRAEFE, Tissue Forceps	39
ELSCHING, forceps	37	GRUENWALD, Forceps, Bayonet – Shaped	40
ENGL.MOD, towel clamps	48		
EPPENDORF, biopsy forceps	115	<b>H</b>	
ESMARCH, cloth and plaster scissors	31	HALLE, vascular spatulas	120
EISELSBERG-MATHIEU, Needle Holders	64	HALSTED-MOSQUITO, haemostatic forceps	50
EXTRACTION PLIERS, Wire Holding forceps	150	HARTMANN, intestinal clamps	87

# Alphabetical Index

HARVEY, plate scissors	29	KELLY, tissue grasping forceps	44
HAJEK-KOFLER, Punches	130	KERN-LANE, bone holding forceps	143
HALSTED, Haemostatic Forceps	52	KERRISON-JACOBY, punches	129
HALSTED-MOSQUITO, Haemostatic Forceps	51	KERSTING, anastomosis forceps	89
HARTMANN, Ear Polypus Forceps	112	KELLY, Haemostatic Forceps	51
HARTMANN-HALLE, Nasal Specula	91	KERRISON, Punches	130
HARTMANN-HERZFELR, Ear Polypus Forceps	112	KILLIAN, bone shear	26
HARTMANN-HOFFMAR, Ear Polypus Forceps	112	KILLIAN, rectal spatula	90
HARTMANN-WULLSTEIN, Ear Polypus Forceps	112	KILNER, fine dissecting scissors	22
HARVEY, Wire Cutters Cutting Scissors	151	KILNER, fine wound retractor	69
HEANEY, needle holder	62	KILNER, dissecting scissor	22
HEGAR, needle holder	62	KILLIAN, Nasal Specula	90
HEGAR-OLSEN, needle holder	63	KIRSCHNER, Cutting Pliers	154
HEGER, uterine dilators	106	KIRSCHNER, Wire Extension	147
HEISS, haemostatic forceps	50	KOCHER, Haemostatic Forceps	52
HEISS, dressing forceps	58	KOCHER, Haemostatic Forceps	54
HEISTER, mouth gag	05	KOCHER-OCHSNER, Haemostatic Forceps	55
HENING, plaster spreader	157	KLIMA ROSEGGGER, trocars	100
HERGET, biopsy forceps	113	KOCHER, retractor	71
HERTZLER, abdominal retractors	84	KOCHER, bladder retractors	99
HERTZLER, rib spreaders	127	KOCHER, bone retractor	74
HESS, tissue forceps	37	KOCHER, retractors	75
HEYMANN-KNIGHT, scissors	25	KOLLE, blood lancet	06
HEYWOOD-SMITH, ovum forceps	109	KONIG, elevators	135
HEYWOOD-SMITH, sponge holding forceps	44	KONIG, raspatories	137
HEYWOOD-SMITH, tongue forceps	05	KONISATION SMESSER, retractors	57
HOLLOW NEEDLE, Suction Instruments	159	KRAUSE, biopsy tip	115
HOUSE, Suction Instruments	161	KRISTELLER, vaginal specula	102
HUBER, biopsy forceps	115	KRISTELLER, vaginal specula	103
HUNT, tumor & vessel forceps	32	KRONECKER, suture instruments	65
HUNTER, splinter forceps	42	KRONLEIN, haemostatic forceps	56
		KUMMEL, intestinal spatula	80
<b>I</b>		<b>L</b>	
INGE, lamina spreaders	83	LABORDE, tracheal dilators	119
INTEROSSEOUS, cartilage knife	12	LAHEY, artery traction forceps	47
IVES-FANSLER, anoscopies	92	LAHEY, gall duct forceps	94
<b>J</b>		LANE TRETOWAN, bone levers	136
JACKSON BURROWS, retractors	82	LANE, bone holding forceps	143
JACOBSON, bone curettes	139	LANE, bone levers	136
JACOBSON, needle holder	61	LANE, tissue forceps	41
JAEGAR, fine wound retractor	69	LANE, towel clamps	48
JAMESON, dissecting scissor	22	LANGE-HOHMANN, bone levers	136
JAMESON, needle holder	62	LANGENBACK, bone levers	135
JANSEN, bone curettes	139	LANGENBECK, with triangle handle	70
JANSEN, bone rongeurs	144	LANGENBECK, flap knife	12
JOHNS-HOPKING, bulldog clamps	49	LARYNGEAL MIRRORS	06
JOLL (FRIEDMAN), retractors	82	LAWRENCE, ligature forceps	58
JOLL, vaginal retractors	105	LANDOLT, Suction Instruments	160
JONES, towel clamps	48	LANDOLT, Suction Instruments	161
JOSEPH, bone file	138	LANGENBECK, Ear Curettes	110
JOSEPH, dura and skin retractor	69	LEBSCHKE, rib shears	126
JOSEPH, raspatories	137	LEGUEU, bladder retractors	99
JUDD-MASSON, bladder retractors	99	LEKSELL-STILLE, bone rongeurs	145
JANSEN, FORCEPS, Bayonet – Shaped	40	LERICHE, intestinal spatula	80
<b>K</b>		LEWIS, bone file	138
KADER, intestinal spatula	80	LISTER, bandage scissor	30
KALT, needle holder	61	LISTER, cloth scissor	30
KELLY, ovum forceps	109	LISTER, sponge forceps	43
KELLY, anoscopies	92	LISTON, bone cutting forceps	146

# Alphabetical Index

LOCKHART-MUMMERY, probes	66	MULLER, dura and skin retractor	69
LOCKWOOD, Intestinal Grasping Forceps	46	MURPHY, head band	03
LUCAE, FORCEPS, Bayonet – Shaped	40	MUSEUX, tissue grasping forceps	47
LUER, Retractors	73	<b>N</b>	
LOCKLIN, delicate scissor	25	NASAL SCISSORS	25
LOPEZ-REINKE, suction instruments	163	NAUJOKS wire scissors	29
LOWER, gall duct forceps	94	NAIL SPLITTING, Finger Nail Instruments	155
LOWMAN, bone clamps	143	NEEDLE HOLDER, for micro surgery	48
LOWMAN-GERSTER, bone clamps	143	NEGUS, tonsil forceps	57
LOWMAN-HOGLUND, bone clamps	143	NELATON, probes	66
LUCAS, gouges	141	NELSON, lung dissecting forceps	41
LUER-KORTE, gall stone scoops	80	NISSEN, gall duct forceps	94
LURE, bone rongeurs	144	NOTO, ovum forceps	109
		NOTO, sponge holding forceps	44
<b>M</b>		NOVAK-SCHOECKAERT, biopsy curettes	111
MAGILL, laryngoscope	07	NOYES, micro spring scissor	15
MALTZ, rasps	138	<b>O</b>	
MANNERFELT, osteotomes	141	OLIVECRONA, dura scissors	24
MANNERFELT, retractors	70	OLIVECRONA, trigeminal knife	13
MARTIN, uterine probes	107	OTOSCOPE SETS	07
MARTINI, bone curettes	139	OTOSCOPE, Diagnostic Sets	07
MASING, retractors	71	<b>P</b>	
MASSON, needle holder	62	PARTSCH, raspatories	137
MASSON-LUETHY, needle holder	62	PARTSCH, gouges	141
MATHIEU, retractors	72	PARTSCH, raspatories	137
MAYO, dissecting scissors	23	PAYR, pylorus clamps	86
MAYO, uterine probes	107	PEAN, haemostatic forceps	57
MAYO-HARRINGTON, dissecting scissors	23	PEAN, haemostatic forceps	51
MAYO-NOBLE, dissecting scissors	23	PEAN, kidney clamps	97
MAYO-STILLE, dissecting scissors	23	PEDERSON, vaginal specula	102
MARTIN, Nasal Specula	90	PEET, splinter forceps	42
MATHIEU, Needle Holders	64	PELKMANN, uterine dressing forceps	108
MATHIEU-STILLE, Needle Holders	64	PERKINS, self retaining retractors	81
MC INDOE, forceps	34	PIERCE, trocars	100
MC KENTY, raspatories	137	PINARD, wooden stethoscope	02
MEAD, mallets	140	PLESTER, retractors	81
MC INDOE, Tissue Forceps	38	PLESTER, suction instruments	163
MCINTOSH, laryngoscopes	09	POOL, suction instruments	162
MEDIUM, Dissecting Forceps	35	POTTS-SMITH, cardiovascular scissor	24
MICRO-HALSTED, Haemostatic Forceps	51	PROBES	67
MILLIN, Needle Holders	64	PARKER, Retractors	73
MICHEL, laryngeal mirrors	06	PEAN, Haemostatic Forceps	52
MICRO SCISSORS, laterally angled	17	PEAN, Haemostatic Forceps	53
MICRO-ADSON, forceps	33	PEAN, Haemostatic Forceps	54
MICRO-ADSON, forceps	37	PENNINGTON, Tissue Grasping Forceps	45
MIDDELDORPF, retractors	75	PROVIDENCE-HOSPITAL, Haemostatic Forceps	51
MIKULICZ, tissue forceps	57	<b>Q</b>	
MIKULICZ, intestinal spatula	80	QUERVAIN, bone levers	113
MIKULICZ, retractors	78	<b>R</b>	
MILLER, laryngoscope	08	RABINER, neurological hammer	01
MILLIN, bladder retractors	99	RANDALL, biopsy curettes	111
MIXTER, ligature forceps	58	RANDALL, kidney stone forceps	98
MOD.USA, plaster spreader	127	RECAMIER, uterine scoops	116
MORRIS, anastomosis clamps	89	REYNOLDS, dissecting scissors	22
MOYNIHAN, haemostatic forceps	57	RICHTER, vaginal retractors	105
MOYO-HEGAR, needle holder	62	ROCHESTER-CARMALT, haemostatic forceps	57
MOD. WIEN, Nasal Specula	91	ROEDER, towel clamps	48
MOLTGEN, Examination & Measuring Instruments	10		
MULLAR, Wire Cutting Plier With T.C. Inserts	187		
MULLER LIGATURE FORCEPS	49		
MULLER VESSEL CLIPS	49		

# Alphabetical Index

ROUX, retractors	72
RUDD, haemorrhoidal ligator	93
RUMEL, dissecting forceps	58
RUSS-MODELL, tissue forceps	41
ROHRSCHEIDER, needle holder	61
ROLLET, dura and skin retractor	69
ROSER KONIG, mouth gag	05
RAMPLEY, Tissue Grasping Forceps	45
RANKIN, Haemostatic Forceps	52
REILL, Cutting Pliers	152
REPLACEMENT LAMP, laryngoscopes	09
ROCHESTER-OCHSNER, Haemostatic Forceps	54
ROCHESTER-PEAN, Haemostatic Forceps	53
ROSE, Retractors	73
ROUND PLIERS, Wire Holding forceps	150

## S

SAENGER, ovum forceps	118
SAMII, tumor grasping forceps	32
SATINSKY, vena cava scissors	24
SAUPE, cilia forceps	42
SCALPEL HANDLES	14
SCHAAF, cilia forceps	42
SCHAEDEL, towel clamps	48
SCHEINMANN, biopsy forceps	115
SCHIMMELBUSCH, ether mask	05
SCHMID, vascular spatulas	120
SCHOEMAKER-LOTH, needle holder	63
SCHOENBORN, retractors	71
SCHRODER, uterine scoops	116
SCHUMACHER, rib shears	126
SCHUMACHER, umbilical scissors	28
SCHUMASHER, biopsy forceps	114
SCOVILLE-RICHTER, retractors	67
SEGOND, myomatome	13
SEIDL, vaginal specula	102
SEIDL-DBP, biopsy forceps	114
SELLORS, rib spreaders	128
SEMKEN, dissecting forceps	34
SEMKEN, tissue forceps	37
SENN-MILLER, Retractors	73
SEUTIN, plaster scissor	31
SHAPLEIGH, Ear Curettes	110
SIMON, uterine scoops	116
SIMPLEX, tongue depressor	04
SIMPSON, uterine probes	107
SIMPSON-BRAUN, obstetrics forceps	117
SIMS, gynaecology scissors	27
SIMS, vaginal specula	102
SIMS, rectal specula	90
SIMS, uterine probes	107
SMOOTH JAWS FORCEPS	34
ST.MARTIN, tissue forceps	37
STEMBERG, tongue depressor	04
STIEGLITZ, splinter forceps	42
STILLE, bone rongeurs	145
STILLE-AESCLAP, plaster shears	156
STILLE-RUSKIN, bone rongeurs	145
STRACK, wire scissor	29
STRASSBURGER Tissue forceps	41
STANDARD, Dissecting Forceps	35
STANDARD, Tissue Forceps	39

STERBERG, Retractors	
STRULLY, cardiovascular scissors (pointed)	24
SUCTION INSTRUMENTS	162
SURGICAL SCISSORS, incision	21
SURGICAL SCISSORS, serrated	20
SURGICAL SCISSORS, slender type	20
SURGICAL SCISSORS, standard	20
SURGICAL SCISSORS, standard	20
SUTURING INSTRUMENT SET	68
SYSTRUNK, nail splitting scissors	21
SPENCER-WELLS, Haemostatic Forceps	
SYSTRUNK, Finger Nail Instruments	

## T

TAKAHASHI, rongeur	112
TAYLOR, percussion hammer	01
TAKAHASHI, Rongeurs	132
THOREK, cardiovascular scissors	24
THORPE, corneal forceps	33
TIECK-HALLE, Nasal Specula	90
TOENNIS, Wire Cutting Plier With T.C. Inserts	187
TOWNLEY, Examination & Measuring Instruments	10
TOBOLD, tongue depressors	04
TOENNIS ADSON, dissecting scissors	22
TOENNIS, dissecting scissors	22
TOENNIS, fine wound retractor	69
TOENNIS, vascular spatulas	120
TOENNIS, needle holder	63
TRELAT, raspatories	137
TRIGEMINAL KNIFE	13
TROCARS	100
TROEMNER, percussion hammer	01
TROUSSEAU, tracheal dilators	119
TROCAR, Suction Instruments	159
TROELTSCH, FORCEPS, Bayonet - Shaped	40
TUFFIER, rib spreaders	127
TUTTLE, lung dissecting forceps	41

## U

UMBILICAL CORD SCISSORS	28
UNIVERSAL BANDAGE SCISSORS	30
UNIVERSAL TROCARS	100
US-ARMY, retractors	72

## V

VANNAS, micro spring scissors	15
VERNIER, Examination & Measuring Instruments	10
WISE GRIP, Wire Holding forceps	150
VOLKMANN, bone curettes	139
VOLKMANN, bone retractors	74

## Alphabetical Index

### W

WANGENSTEEN, needle holder	62
WARTENMERG, pinwheel	01
WAGNER, Rongeurs	134
WAUGH, Tissue Forceps	38
WEBER, anastomosis clamps	124
WECKER, eye scissors	15
WEIL-BLAKESLEY, rongeurs	112
WEITLANER, self retaining retractors	81
WERTHEIM, gynaecology scissors	27
WERTHEIM, clamps and forceps	59
WERTHEIM-CULLEN, vaginal clamps	60
WIEDER, tongue depressor	04
WEIL-BLAKESLEY, Rongeurs	132
WILLIGER, bone curettes	139
WILLIGER, elevators	135
WILLIGER, raspatories	137
WINTER, ovum forceps	118
WILDE, Forceps, Bayonet – Shaped	40
WOLFF, plaster breakers	157
WULLSTEIN, retractors	81
WULLSTEIN, Suction Instruments	160

### Y

YASARGIL, needle holder	61
YASARGIL, tumor grasping forceps	32
YASARGIL-SAMII, tumor grasping forceps	32
YASARGIL, Suction Instruments	160
YASARGIL, Suction Instruments	161
YASARGIL, micro scissors	17
YEOMAN, biopsy forceps	113
YOUNG, tongue forceps	05
YOUNG– HRYNTSCHAK, Needle Holders	64
YOUNG-MILLIN, Needle Holders	64

### Z

ZENKER, ligature	58
ZENKER, retractors	77
ZIEGLER, head band	03
ZIEGLER, head mirror	03



**ES**  
**ELIXIR SURGICAL**



☎ : +966-56-5176399

☎ : +92-322-2182828

✉ : [info@elixirsurgical.com](mailto:info@elixirsurgical.com)

🌐 : [www.elixirsurgical.com](http://www.elixirsurgical.com)