



ELIXIR SURGICAL
الإكسير سرجكل

Bringing Reliability,
Innovation and
Value To
Healthcare

Manufacturers & Exporters of Surgical & Dental Instruments



Dental
Instruments
Catalogue





Profile

Elixir Surgical believes in bringing Reliability, Innovation and Value to the healthcare sector. And today as one of the world's leading Surgical and Dental instrument companies; we continue our commitment to advancing dental performance by supporting these products with world class service, support, education and peer communities.

Elixir Surgical is much more than a supplier of high precision Medical Class I Devices: a partner who listens carefully and contributes ideas, who understands the customers' needs and requirements and provides for them on a high level so that they can perform at the highest level.

This assurance is rooted in the knowledge that all instruments are precision designed and produced under strict quality control procedures. A large number of new orders delivered every year to the medical facilities across the world testify to the high level of confidence by the healthcare professionals in our products. Our systems and quality are guided by CE Class I Device certification, ISO: 9001 & ISO: 13485 accreditation.

All Instruments are made from durable, surgical-grade stainless steel, crafted to demanding standards and tolerances. Each product is rigorously tested for reliability and performance parameters. The premier OR-Grade Instruments are designed to meet the Exacting Standards and come with a guarantee against Cracking, Breaking, Pitting and Rusting.

Elixir Surgical is headquartered in Pakistan, and prides itself on the highly skilled staff to produce accurate hand-crafted instruments of exacting standards. As such, we are committed to 'raising the bar' in every aspect of our business, from customer service to product development. This commitment takes the form of superior products that perform impeccably and to experts requirements.

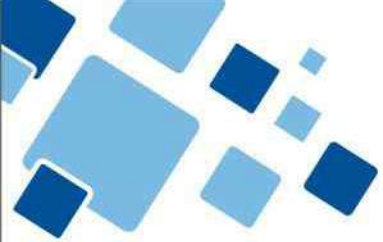

Table Of Contents



01	Tooth Extracting Forceps	01-49	████████████████████
02	Root Elevators	50-70	████████████████████
03	Scalpel Handles, Handles, Mouth Mirrors Scalers, Explorer / Probes	71-85	████████████████████
04	Endodontic Condensers, Obturation Instruments Excavators, Explorer / Probes, Curette Sets	86-96	████████████████████
05	Amalgam Pluggers / Condensers, Burnishers	97-100	████████████████████
06	Wax Carvers, Carvers, Chisels	101-103	████████████████████
07	Compsite Placement, Plastic Filling Instruments	104-107	████████████████████
08	Curettes, Gracey Curettes, Dental Products, Knives	108-117	████████████████████
09	Wax Porcelain & Cement Instruments Wax & Modeling Instruments	118-121	████████████████████
10	Spatulas, Cement Spatulas	122-124	████████████████████
11	Files, Hoes, Knives, Wax & Plaster Knives, Crane Kaplan	125-128	████████████████████
12	Bone Curettes, Bone Files, Bone Chisels, Bone Mallets	129-133	████████████████████
13	Crown Removers, Crown Instruments	134-136	████████████████████

14	Implants & Measuring Instruments, Suction Tubes, Bone Gauges	 137-144 	
15	Amalgam Guns & Carriers, Retainers, Bands, Strip Holders, Napkin Holders	 145-146 	
16	Rubber Dam Instruments, Rubber Dam Clamps	 147-148 	
17	Syringes, Tweezers, Sterilizing & Lab Instruments	 149-156 	
18	Endodontic Forceps, Tissue Forceps, Haemostatic Forceps, Towel Clamps	 157-159 	
19	Retractors, Lip & Cheek Retractors, Hooks, Depressors & Mouth Gags, Sterilizing Forceps	 160-164 	
20	Orthodontic Pliers & Cutters, Rongeurs	 165-179 	
21	Needle Holders, Scissors, Micro Surgery Set	 180-186 	
22	Impression Trays	 187-193 	
23	Articulators, Hollow Wares	 194-200 	
24	Scissors, Dissecting Forceps, Needle Holders, Wire Cutting Pliers With Tungsten Carbide Inserts	 201-213 	
25	Dental Implants Instruments	 214-216 	
26	Dental Instruments Sets	 217 	



الإكسير سرجكل
ELIXIR SURGICAL

- ✦ Extracting Forceps
- ✦ Root Elevators



01
SECTION





1001
Fig. 4
lower incisor



1001
Fig. 4
lower incisor



1002
Fig. 8
lower premolar



1002
Fig. 8
lower premolars



1003
Fig. 1
upper centrals & canines



1004
Fig. 2
upper laterals & canines



1005
Fig. 3
upper incisors & canines



1006
Fig. 4
upper incisors & canines

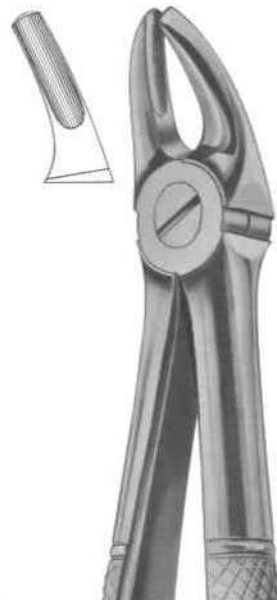

1007
Fig. 7
upper premolars



1008
Fig. 8
lower premolars



1009
Fig. 13
lower premolars



1010
Fig. 13S
lower premolars
for children.

1011
Fig. 17
upper molars, right

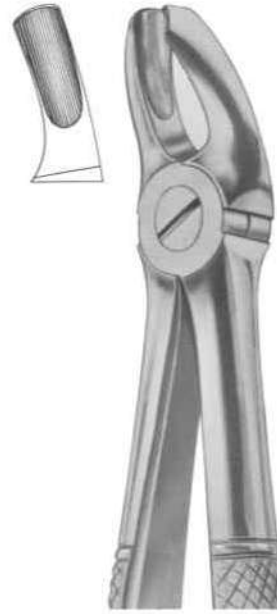

1012
Fig. 18
upper molars, left

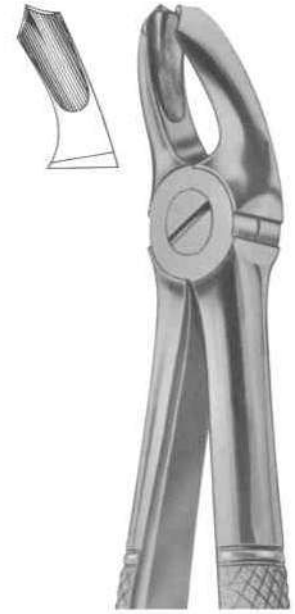

1013
Fig. 18A
upper molars

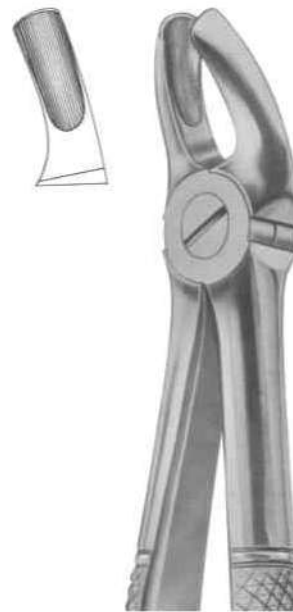

1014
Fig. 18B
upper molars



1015
Fig. 19
upper third molars



1016
Fig. 20
upper third molars

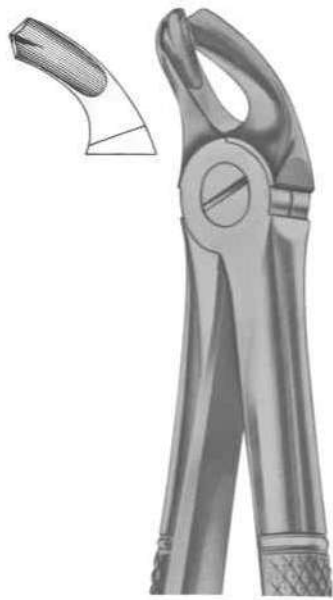

1017
Fig. 21
lower molars

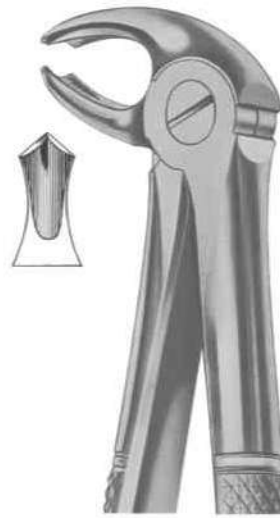

1018
Fig. 22
lower molars

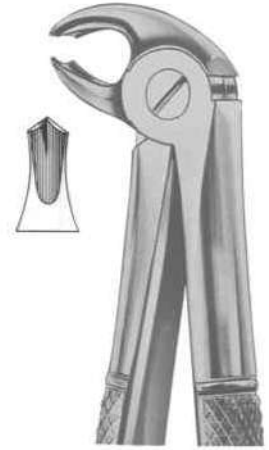

1019
Fig. 22S
lower molars
for children

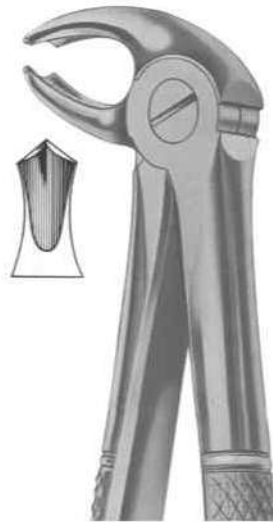

1020
Fig. 22G
lower molars

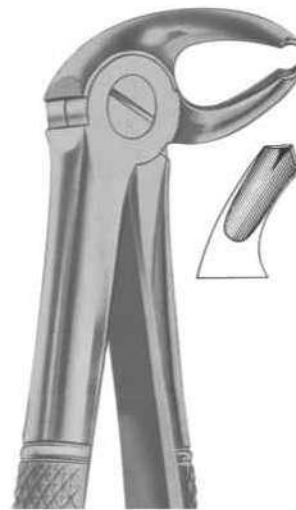

1021
Fig. 23
lower molars right

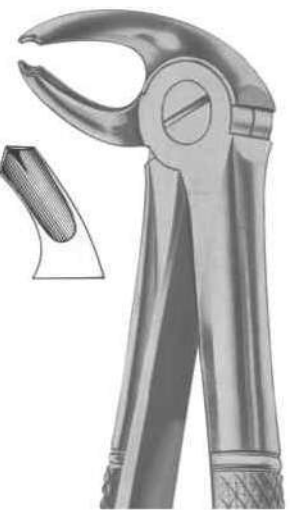

1022
Fig. 24
lower molars left



1023
Fig. 29
upper roots



1024
Fig. 29S
upper roots for children



1025
Fig. 30
upper roots



1028
Fig. 30S
upper roots
for children

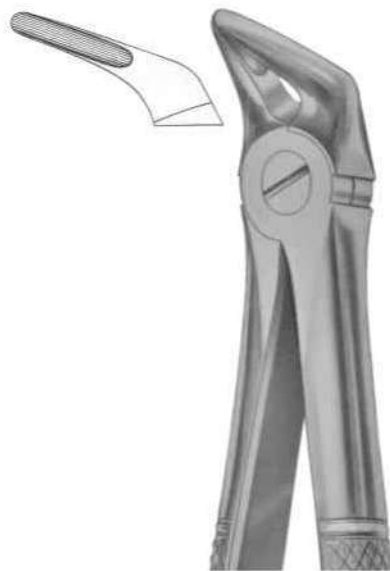

1026
Fig. 31
lower roots



1027
Fig. 32
lower molars



1029
Fig. 33
lower roots



1030
Fig. 33A
lower roots



1031
Fig. 33B
lower roots

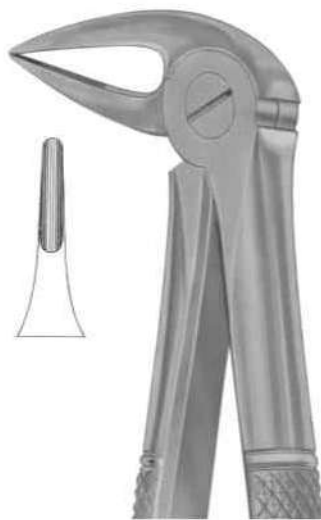

1032
Fig. 33L
lower roots



1033
Fig. 37
upper incisors
for children



1034
Fig. 33S
lower roots
for children



1035
Fig. 38
lower incisors &
canines for children



1036
Fig. 39
upper molars
for children



1037
Fig. 39R
upper molars right
for children



1040
Fig. 39L
upper molars left
for children



1038
Fig. 39A
upper molars
for children



1039
Fig. 40
lower molars
for children



1041
Fig. 41
upper roots



1042
Fig. 44
upper roots

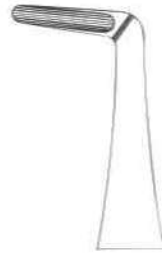

1043
Fig. 45
lower roots

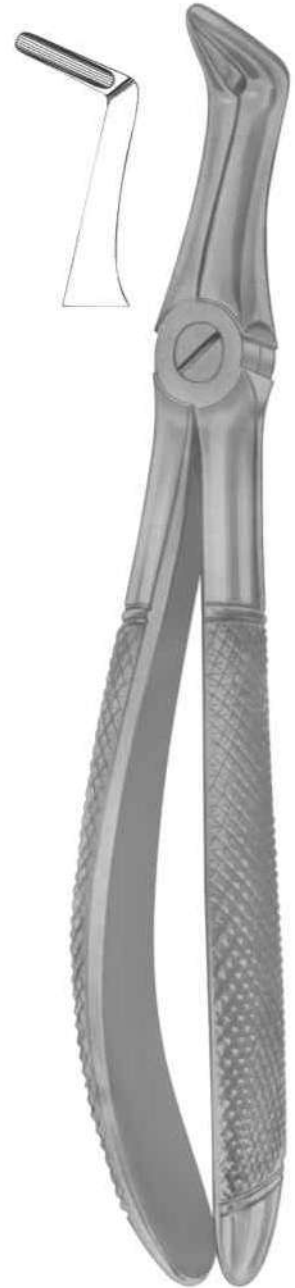

1046
Fig. 50
upper roots



1044
Fig. 48
lower roots



1045
Fig. 49
upper roots



1047
Fig. 51
upper roots



1048
Fig. 51A
upper roots

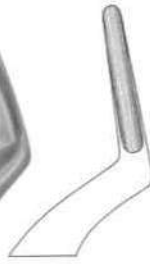

1049
Fig. 51L
upper roots

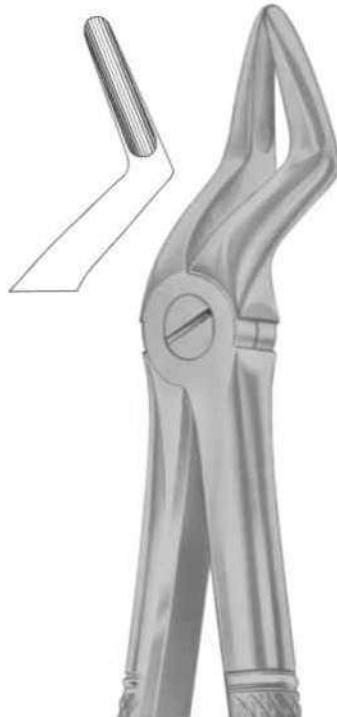
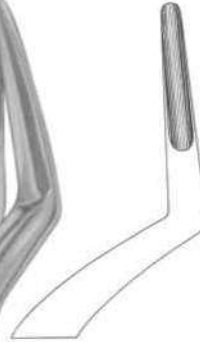

1050
Fig. 52
upper roots

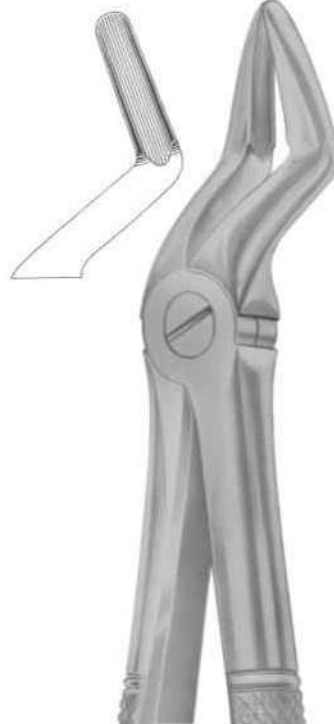

1051
Fig. 52A
upper teeth
and resection

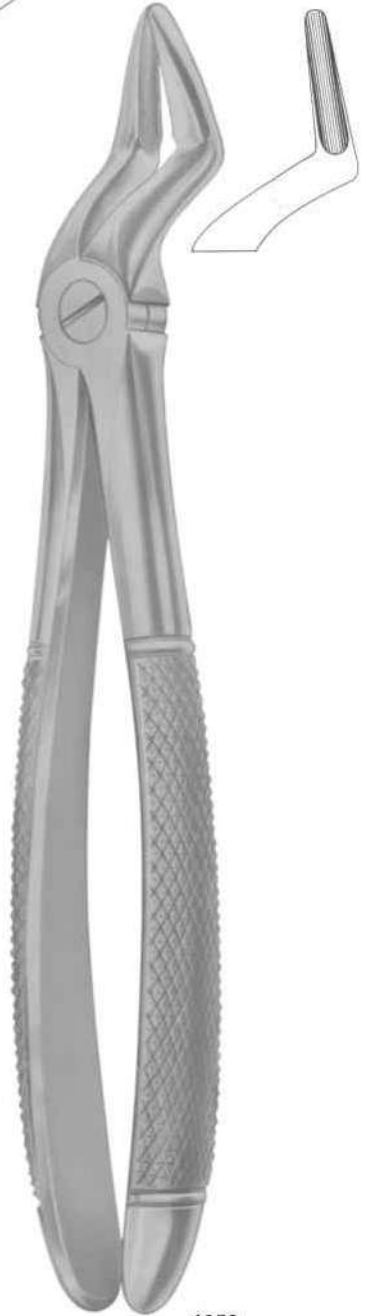

1052
Fig. 51S
upper roots
for children



1053
Fig. 54
for separating
upper molars



1054
Fig. 55
for separating
upper molars



1055
Fig. 56
for separating
lower molars

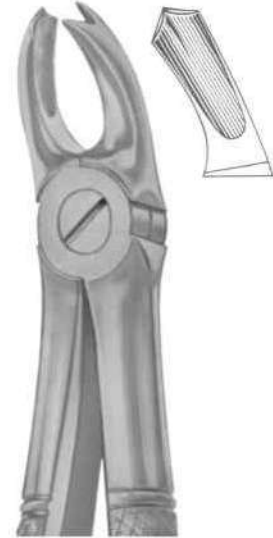

1056
Fig. 65R
upper molars
right

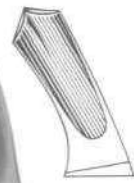

1057
Fig. 65L
upper molars left



1058
Fig. 67
upper third molars

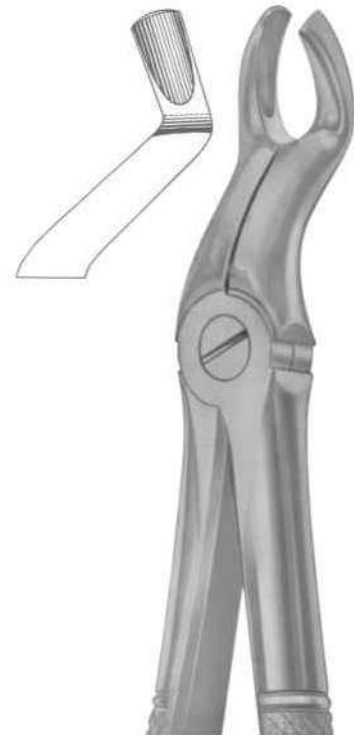

1059
Fig. 67A
upper third molars



1060
Fig. 67 1/2R
upper third molars
right



1061
Fig. 67 1/2L
upper third molars
left



1062
Fig. 68
lower roots



1063
Fig. 68A
lower roots



1064
Fig. 73
lower molars

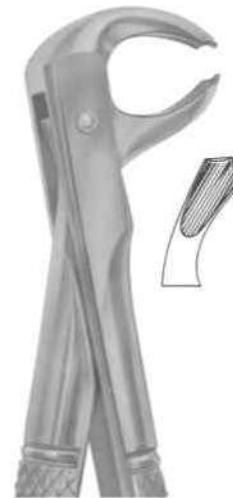

1065
Fig. 73R
lower molars right



1066
Fig. 73L
lower molars left



1067
Fig. 73A
lower molars



1068
Fig. 73S
lower molars



1069
Fig. 73B
lower molars for children



1072
Fig. 73K
lower molars
for children

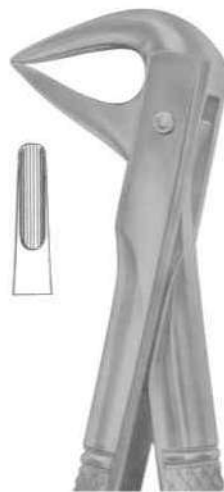

1070
Fig. 74
lower roots



1071
Fig. 74D
lower roots



1073
Fig. 74M
lower roots



1074
Fig. 74N
lower roots



1075
Fig. 74XN
lower roots and
crowded incisors



1078
Fig. 76N
upper roots

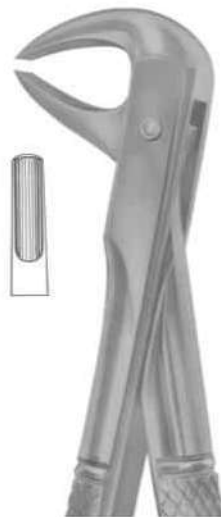

1076
Fig. 75
lower premolars



1077
Fig. 76
upper roots



1079
Fig. 76S
upper roots



1080
Fig. 79
lower third molars



1081
Fig. 79A
lower third molars

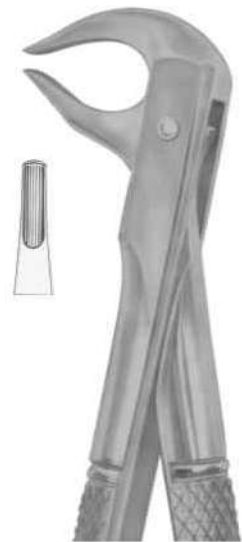

1082
Fig. 81
lower premolars
and roots



1083
Fig. 86A
lower molars



1084
Fig. 86B
lower molars



1085
Fig. 86C
lower molars



1086
Fig. 87
lower molars



1087
Fig. 91
for separating
lower molars



1088
Fig. 99
lower molars

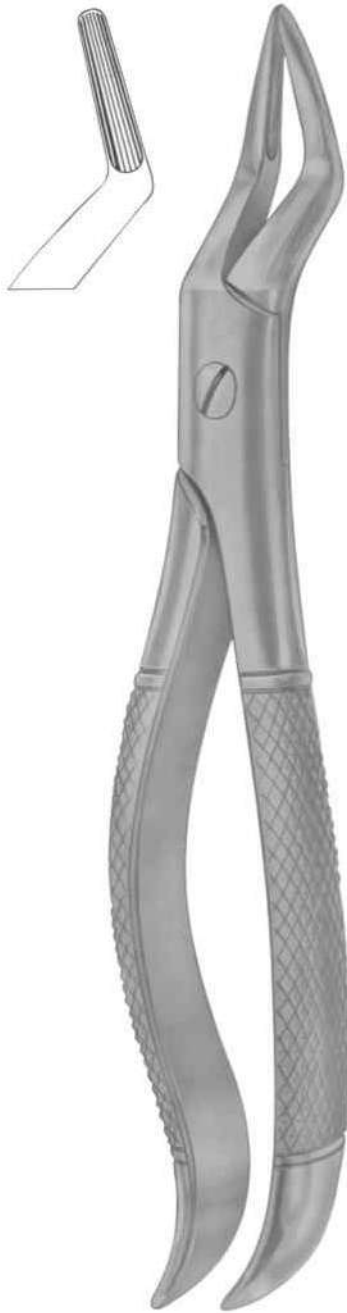

1089
Fig. 101
upper premolars
and roots



1090
Fig. 100
upper roots



1091
Fig. 99 1/4
lower molars



1092
Fig. 99 1/2
lower molars



1093
Fig. 102
upper molars right



1094
Fig. 103
upper molars left



1095
Fig. 105
lower incisors



1096
Fig. 106
lower incisors

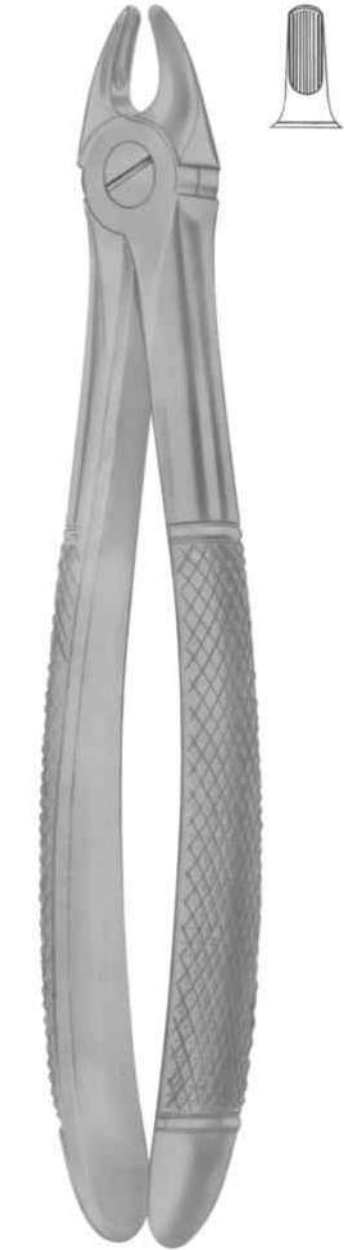

1097
Fig. 103
upper canines



1098
Fig. 112
upper roots

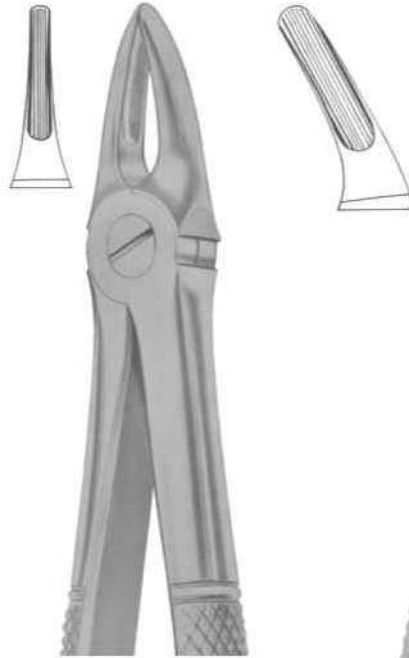

1099
Fig. 113
upper roots



1101
Fig. 136
upper premolars
and roots

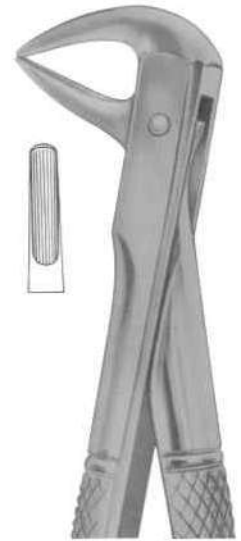

1102
Fig. 137
lower incisors
and roots



1100
Fig. 114
upper roots



1103
Fig. 143
lower roots

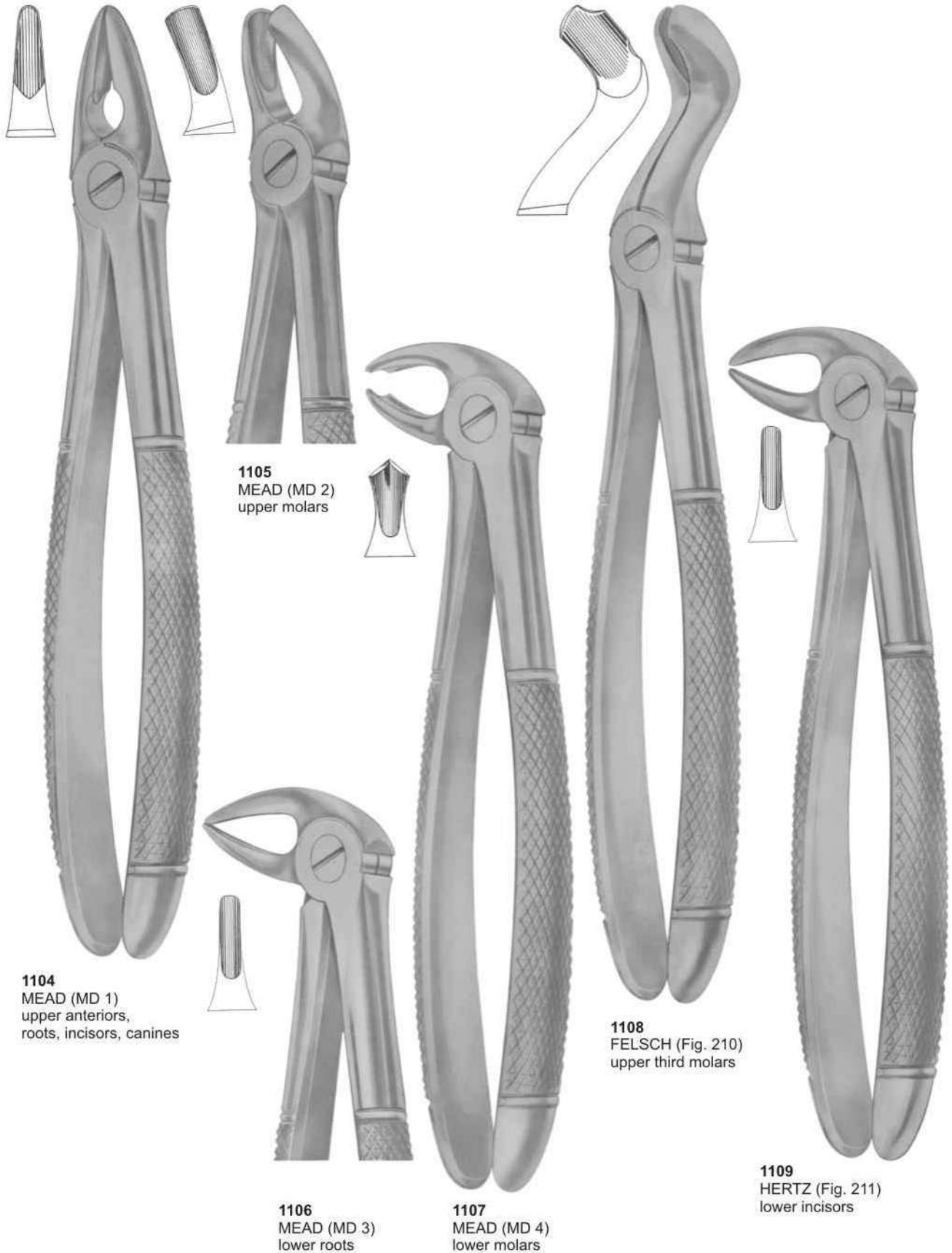



1110
ROUTURIER (Fig. 212)
(22 ½ L)
lower molars
and wisdom left

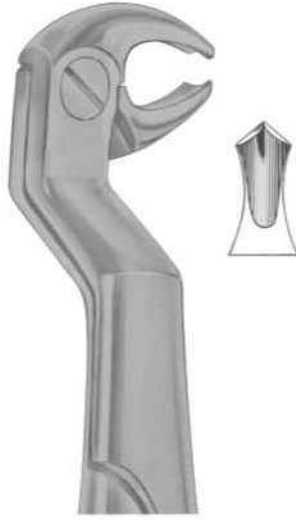

1111
ROUTURIER (Fig. 213)
(22 ½ R)
lower molars
and wisdom right



1112
ROUTURIER (Fig. 214)
(22 ½ L)
lower molars
and wisdom left



1113
ROUTURIER (Fig. 215)
(33 ½ R)
lower molars
and wisdom right



1114
RESECTION FORCEPS
(216/Witzel)
upper roots



1115
Fig. 5



1116
Fig. 6



1117
Fig. 9



1118
Fig. 10



1119
Fig. 11



1120
Fig. 12



1121
Fig. 14



1122
Fig. 15



1123
Fig. 25



1124
Fig. 26



1125
Fig. 27



1126
Fig. 28



1127
Fig. 34



1128
Fig. 35



1129
Fig. 42



1130
Fig. 43



1131
Fig. 44A



1132
Fig. 46



1133
Fig. 47



1134
Fig. 50A



1135
Fig. 74R



1136
Fig. 74L



1137
Fig. 75R



1138
Fig. 75L



1139
Fig. 94



1140
Fig. 95



1141
Fig. 98



1142
Fig. 105



1143
Fig. 106



1144
Fig. 2002



1145
Fig. 1
upper laterals
and canines



1146
Fig. 2
upper laterals
and canines

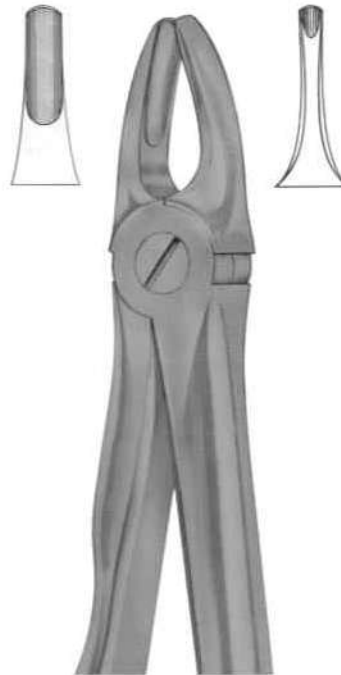

1147
Fig. 3
upper incisors
and canines

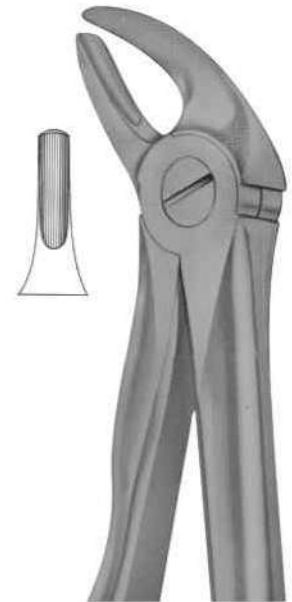

1148
Fig. 4
lower incisors
and canines

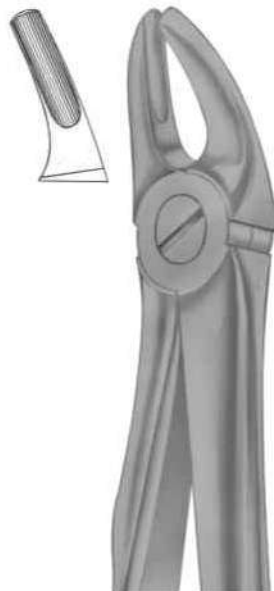

1149
Fig. 7
upper premolars

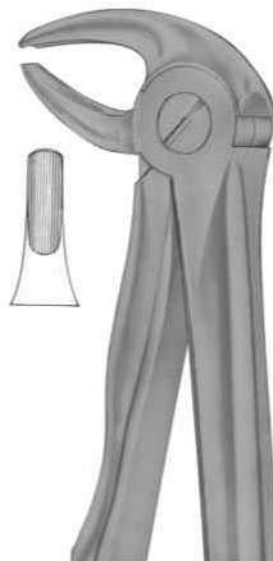

1150
Fig. 13
lower premolars



1151
Fig. 13S
lower premolars
for children



1152
Fig. 17
upper molars right



1153
Fig. 18
upper molars left



1154
Fig. 18A
upper molars

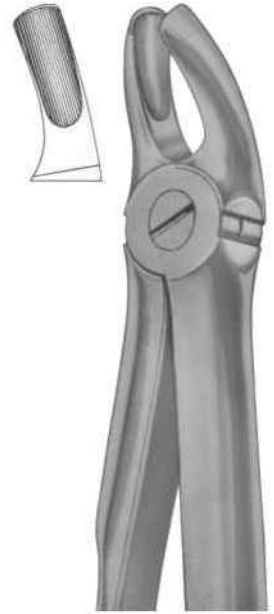

1155
Fig. 18B
upper molars



1156
Fig. 19
upper third molars



1157
Fig. 22
lower molars



1158
Fig. 22S
lower molars
for children



1159
Fig. 29
upper roots



1160
Fig. 29S
upper roots
for children



1161
Fig. 30
upper roots



1162
Fig. 30S
upper roots
for children

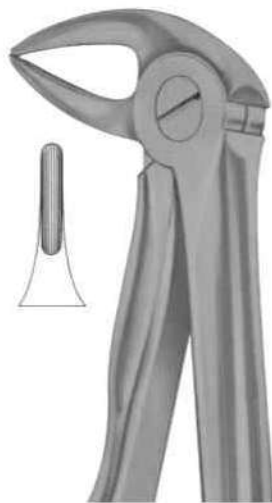

1163
Fig. 33
lower roots



1164
Fig. 33A
lower roots

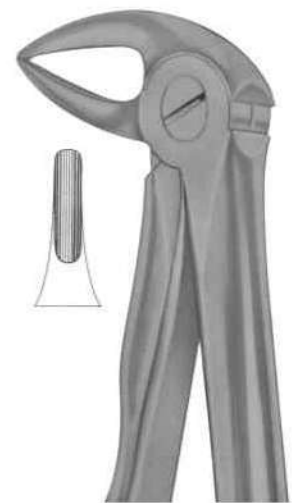

1165
Fig. 33B
lower roots



1166
Fig. 33L
lower roots



1167
Fig. 33S
lower roots
for children



1168
Fig. 37
upper incisors
for children



1169
Fig. 39
upper incisors
for children



1170
Fig. 39A
upper molars
for children



1171
Fig. 39R
upper molars right
for children



1172
Fig. 39L
upper molars left
for children



1173
Fig. 41
upper roots

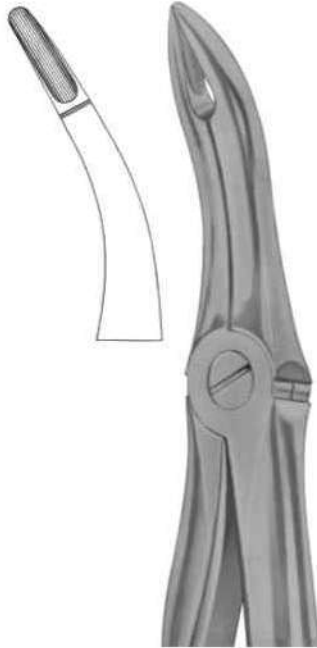

1174
Fig. 44
upper roots

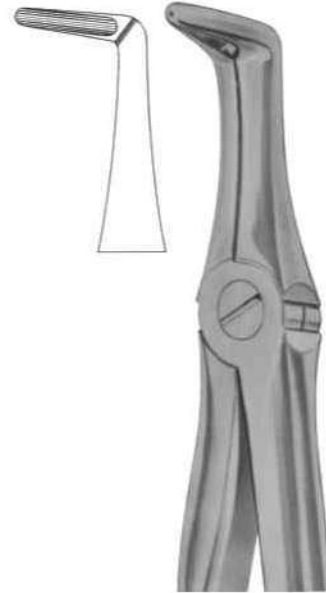

1175
Fig. 45
lower roots

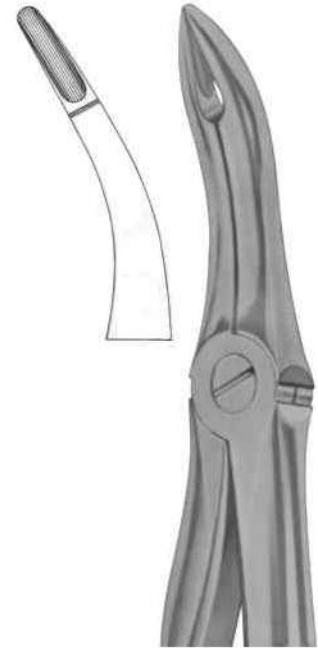

1176
Fig. 48
lower roots



1177
Fig. 51
upper roots

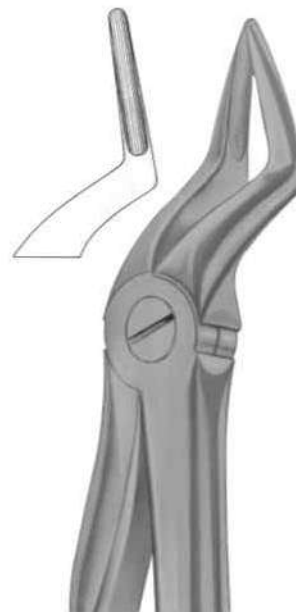

1178
Fig. 51A
upper roots



1179
Fig. 51S
upper roots
for children



1180
Fig. 51L
upper roots

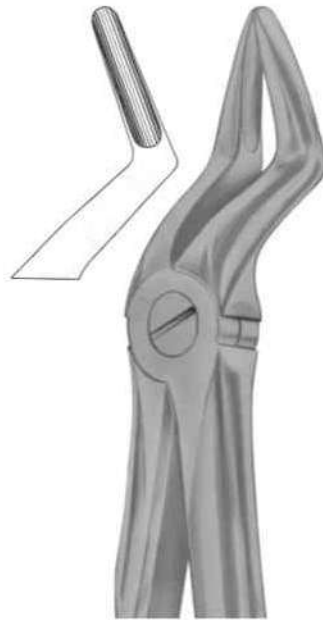

1181
Fig. 52
upper roots



1182
Fig. 54
for separating
upper molars



1183
Fig. 65R
upper molars right

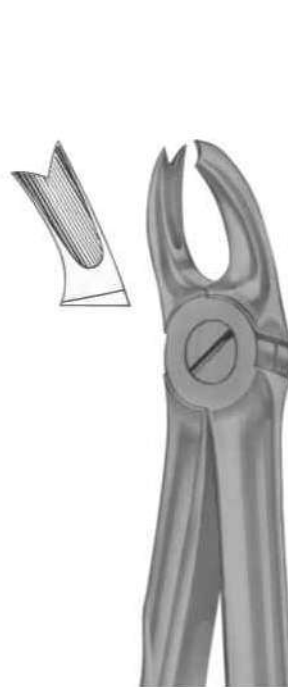

1184
Fig. 65L
upper molars left



1185
Fig. 67
upper third molars

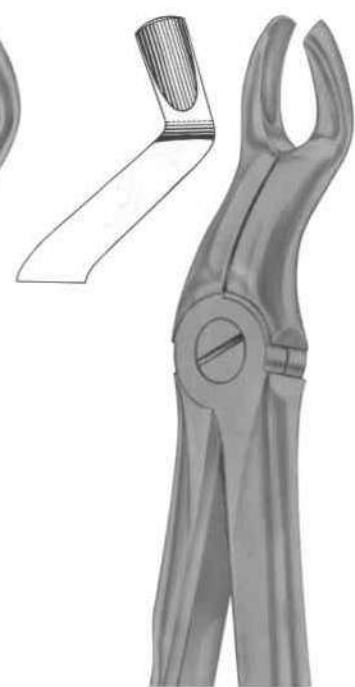

1186
Fig. 67A
upper third molars



1187
Fig. 67 1/2 R
upper third molars
right

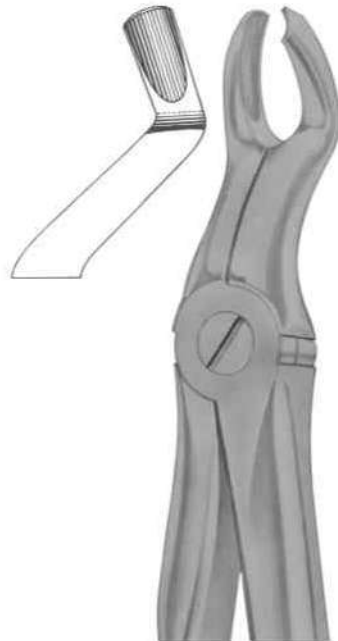

1188
Fig. 67 1/2 L
upper third molars
left



1189
Fig. 73
lower molars

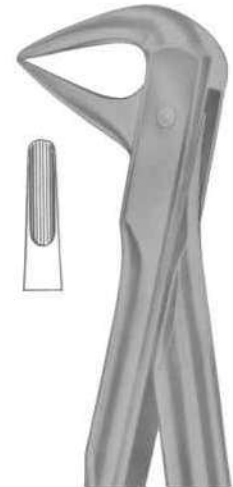

1190
Fig. 74
lower roots

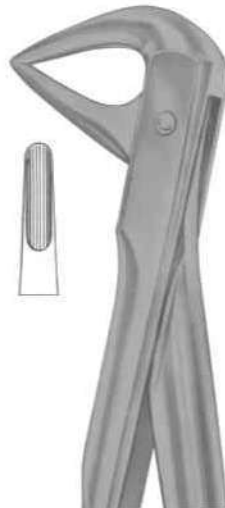

1191
Fig. 74M
lower roots



1192
Fig. 74N
lower roots



1193
Fig. 74XN
lower roots and
crowded incisors



1194
Fig. 75
lower premolars



1195
Fig. 76
upper roots



1196
Fig. 76N
upper roots



1197
Fig. 81
lower premolars
and roots

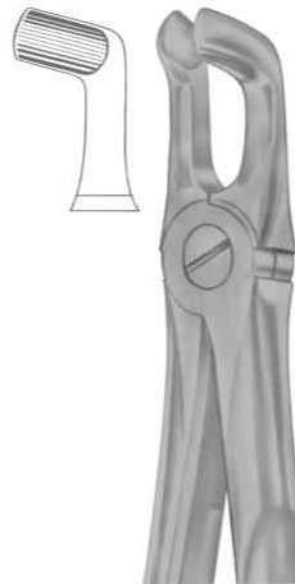

1198
Fig. 76A
lower third molars



1199
Fig. 79
lower third molars



1200
Fig. 86A
lower molars



1201
Fig. 86B
lower molars



1202
Fig. 86C
lower molars



1203
Fig. 99
lower molars



1204
Fig. 99 1/4
lower molars

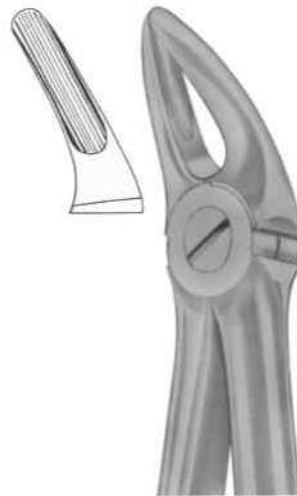

1205
Fig. 136
upper premolars
and roots



1206
Fig. 143
lower roots



1207
KLEIN (Fig. 217)
upper incisors



1208
KLEIN (Fig. 218)
upper premolars



1209
KLEIN (Fig. 219)
upper roots



1210
KLEIN (Fig. 220)
upper molars



1214
ALBRECHT
Fig. 224
Deciduous



1215
ALBRECHT
Fig. 225
Deciduous



1211
KLEIN (Fig. 221)
lower incisors



1212
KLEIN (Fig. 222)
lower molars



1213
KLEIN (Fig. 223)
lower roots

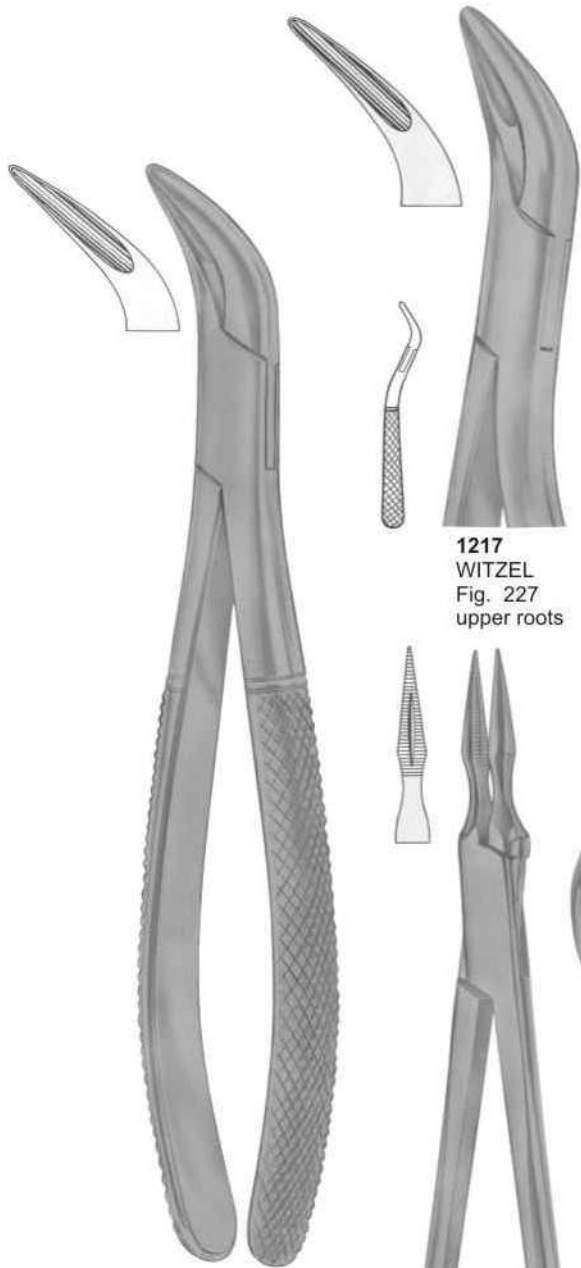

1217
WITZEL
Fig. 227
upper roots

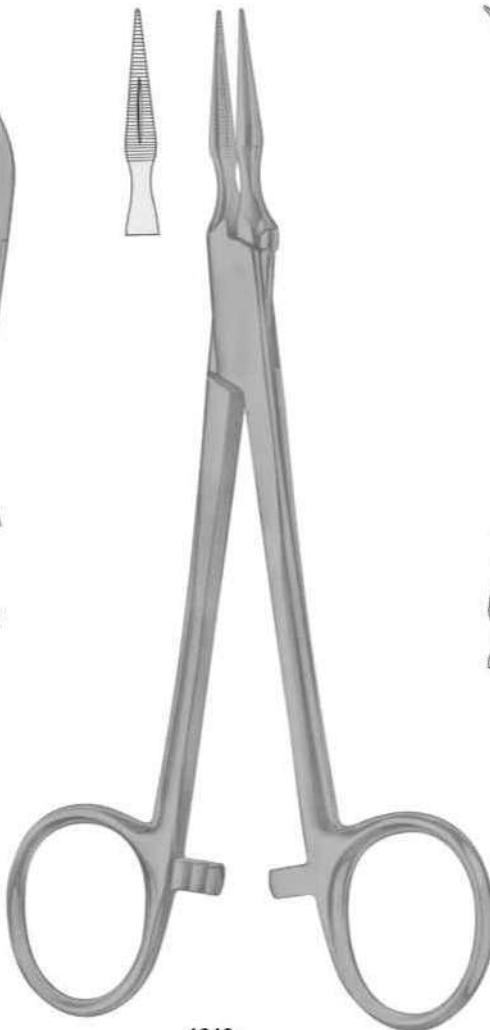

1219
STIEGLITZ
Fig. 229
root fragments

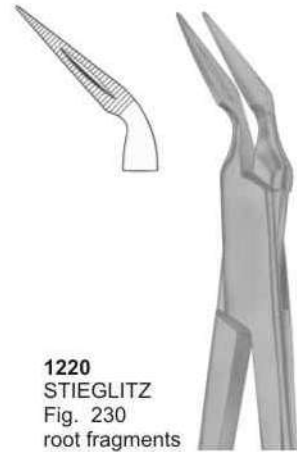

1220
STIEGLITZ
Fig. 230
root fragments



1221
RALK
Fig. 231
root fragments

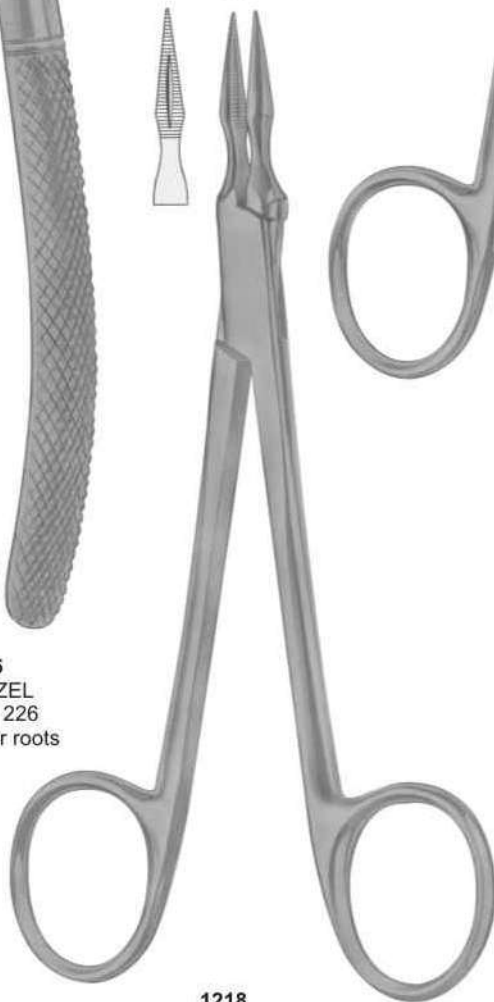

1216
WITZEL
Fig. 226
lower roots



1218
ARTHUR
Fig. 228
root fragments



1222
W1-WINTER
upper centrals
and canines

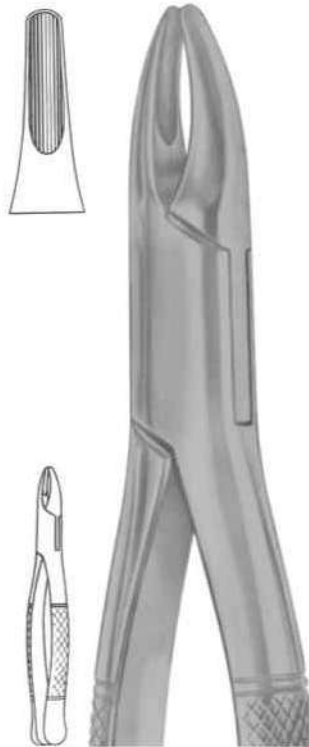

1223
Fig. 1
upper incisors and roots

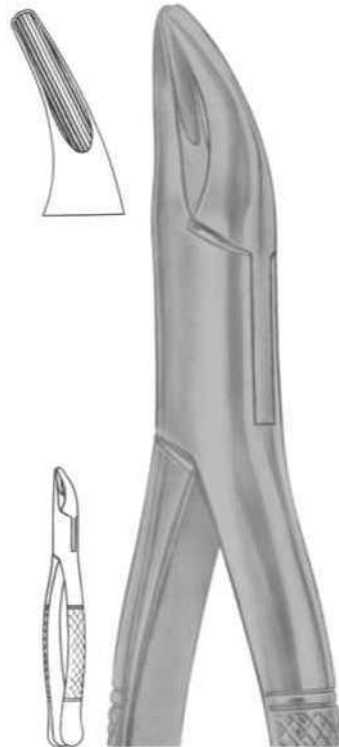

1224
Fig. 2
upper and lower roots

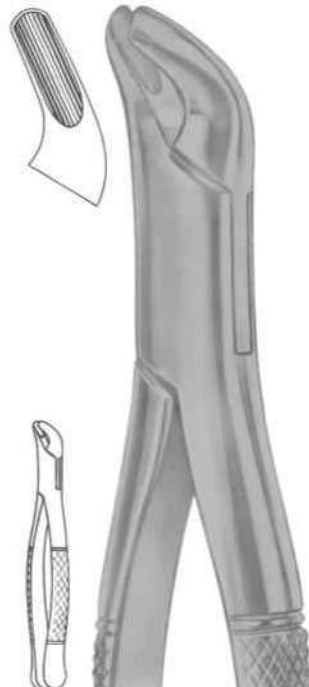

1225
Fig. 4
upper and lower premolars

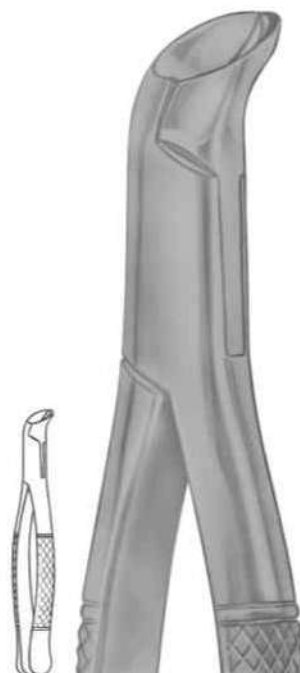

1226
PHYSICK
Fig. 5
lower third molars

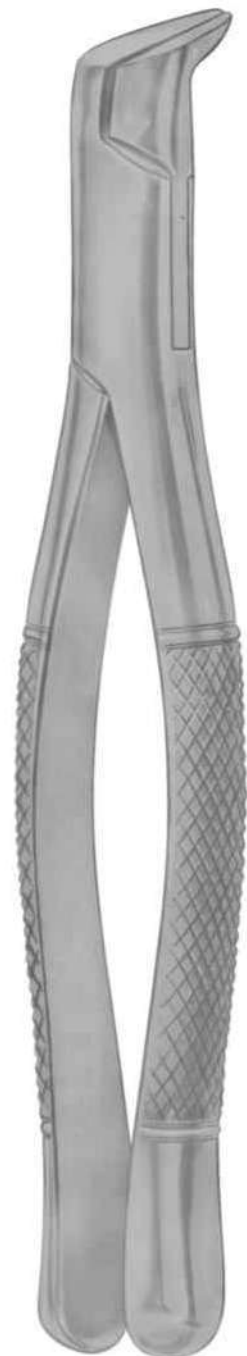

1227
Fig. 6
separating
forceps



1228
Fig. 7
upper roots

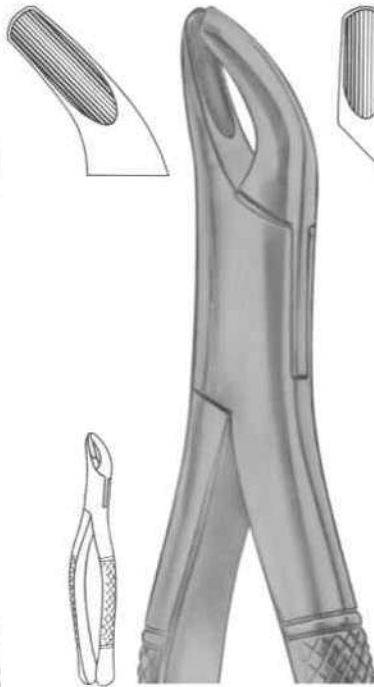

1229
Fig. 8
upper and lower
third molars



1231
Fig. 10H
upper molars



1232
Fig. 13
upper incisors

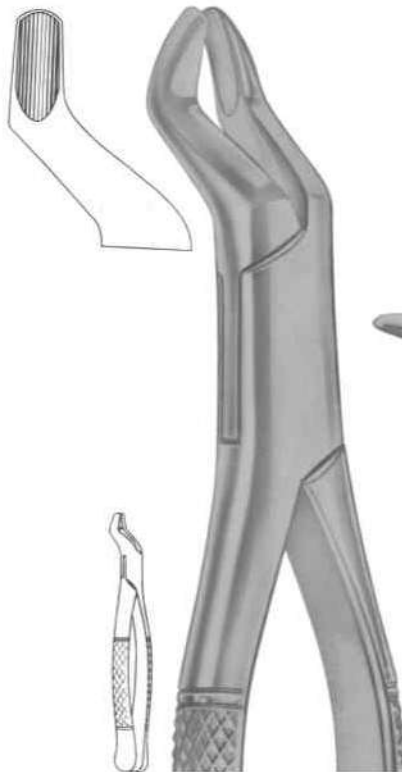

1230
Fig. 10S
upper molars



1233
Fig. 14
lower incisors

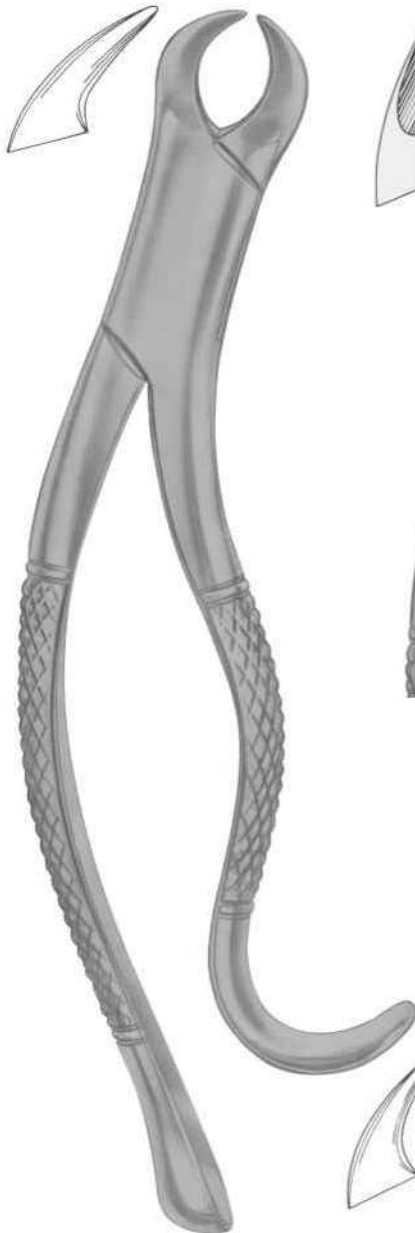

1234
Fig. 16
lower molars



1235
HARRIS
Fig. 15
lower molars

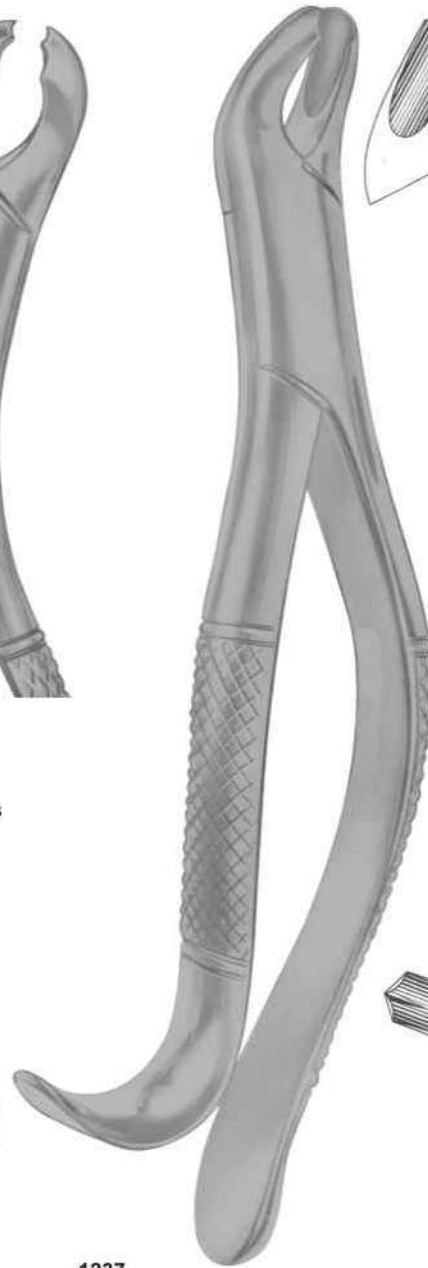

1237
HARRIS
Fig. 18R
upper molars right



1238
HARRIS
Fig. 18L
upper molars left



1236
Fig. 16S
lower molars
for children

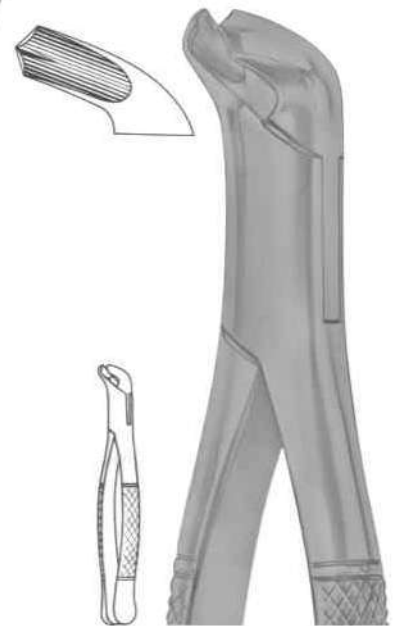

1239
Fig. 17
lower molars

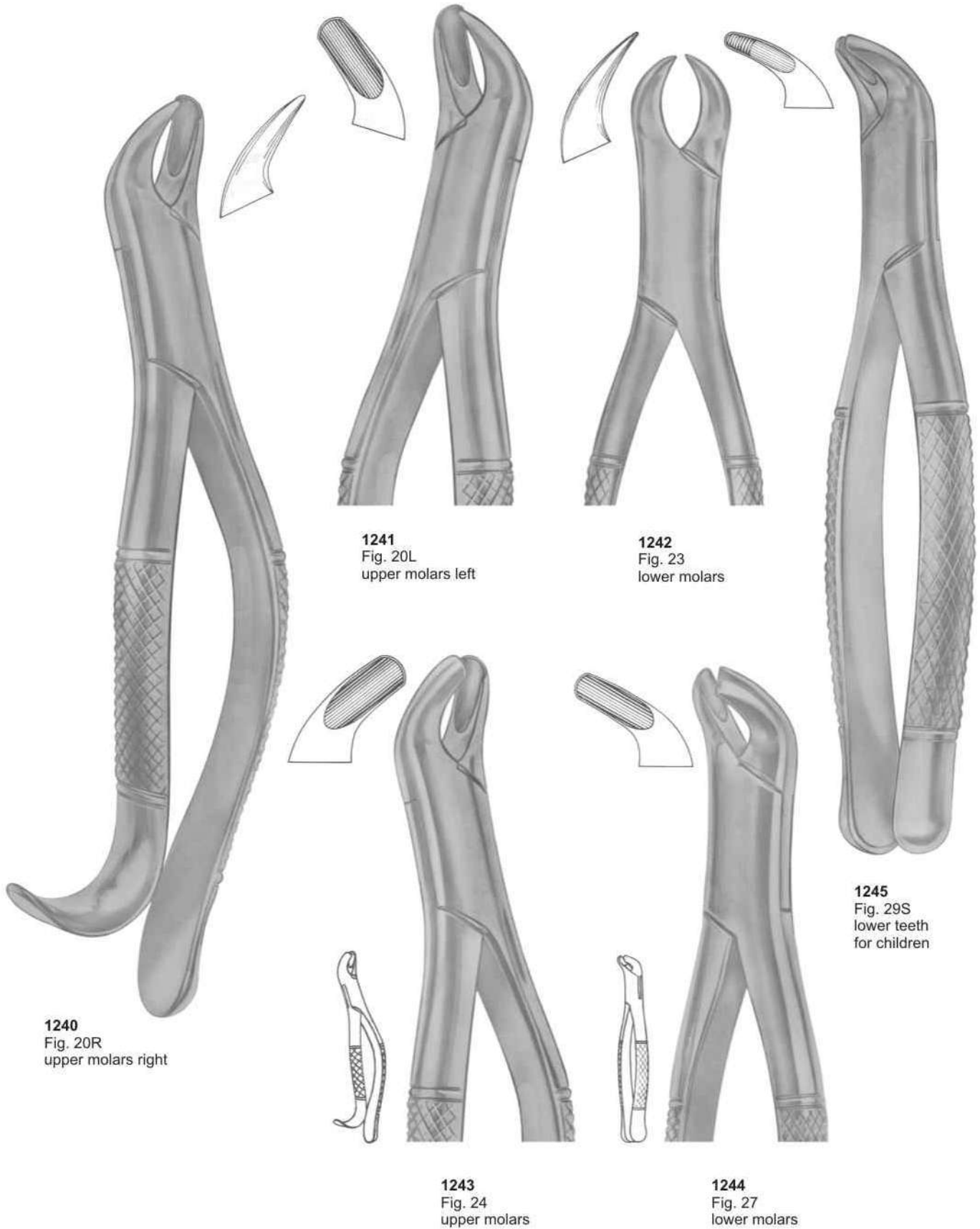



1246
Fig. 30S
upper teeth
for children

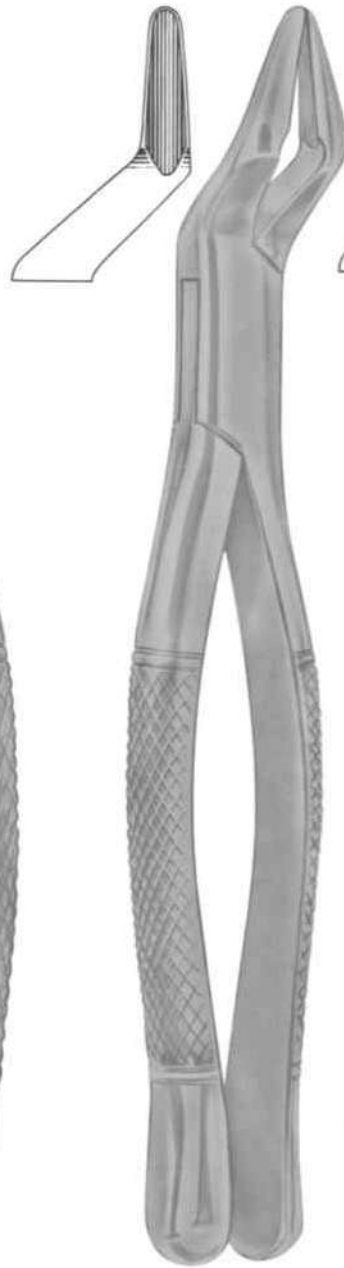

1247
PARMLY
Fig. 32
upper premolars
and molars



1248
PARMLY
Fig. 32A
upper premolars
and roots



1249
Fig. 34
lower anteriors
and roots



1250
Fig. 35
upper roots



1251
Fig. 36
lower anteriors
and roots



1252
Fig. 37
lower anteriors
and roots

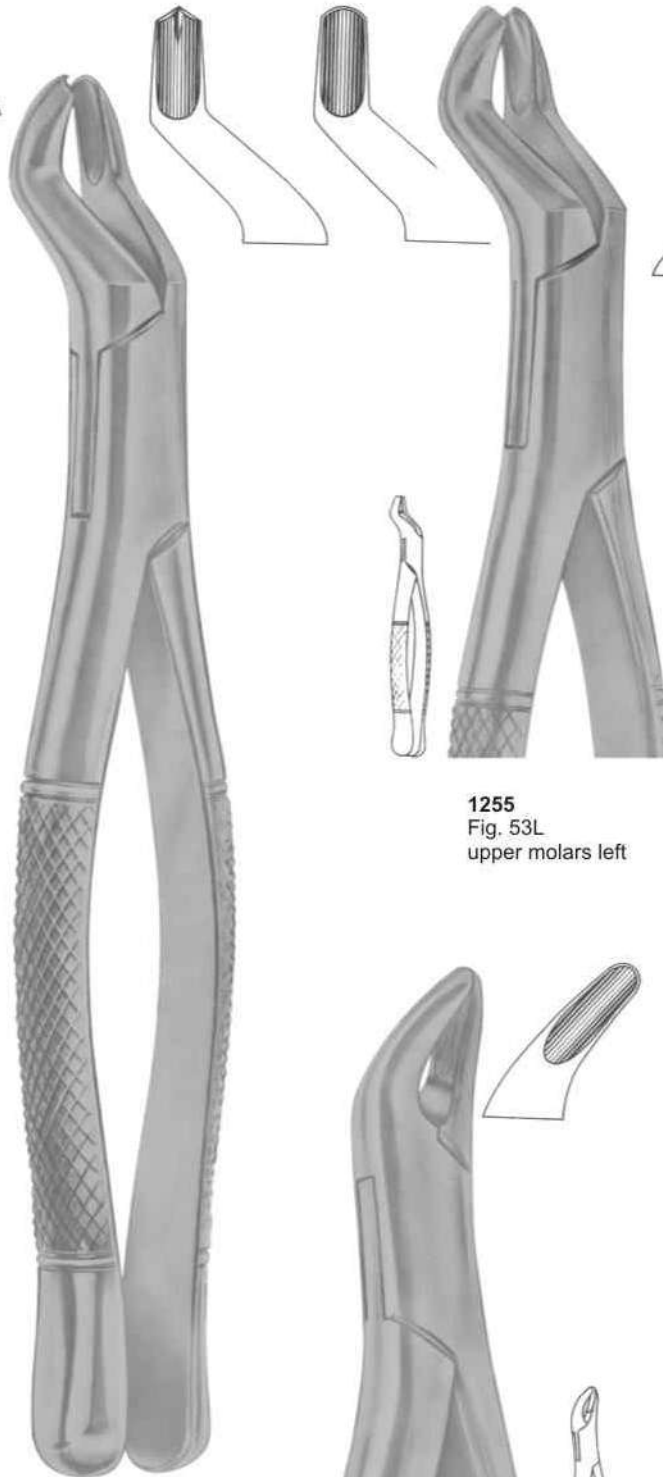

1254
Fig. 53R
upper molars right



1255
Fig. 53L
upper molars left

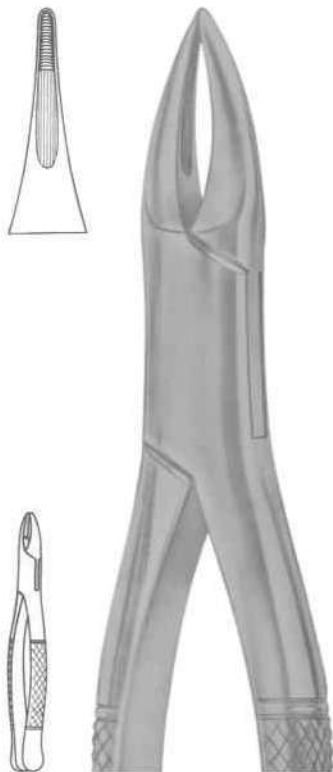

1253
Fig. 38
upper anteriors
and roots



1256
Fig. 62
incisors, premolars,
deciduous teeth

1257
Fig. 65
upper incisors
and roots



1258
TAMES
Fig. 69
upper and lower roots



1259
TAMES
Fig. 85
lower canines,
premolars and molars

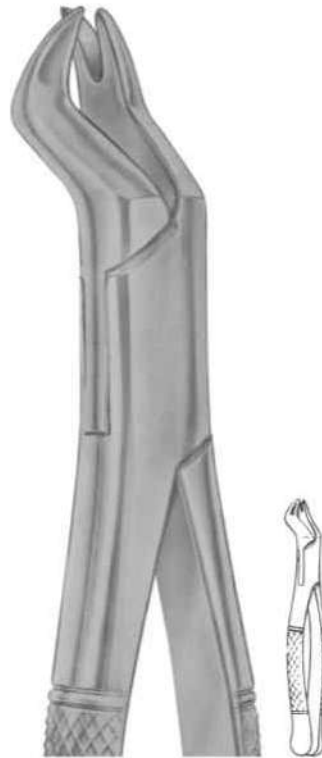

1260
NEVIUS
Fig. 88R
upper molars right



1262
NEVIUS
Fig. 88L
upper molars left



1261
THOMAS
Fig. 85A
lower canines,
premolars and molars



1263
KELLS
Fig. 99A
upper incisors,
canines, premolars

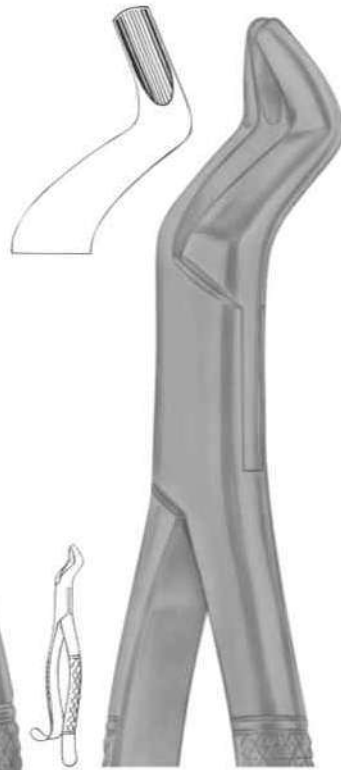

1264
Fig. 104
upper third molars



1266
HULL
Fig. 101
deciduous teeth



1267
Fig. 103
lower incisors,
premolars

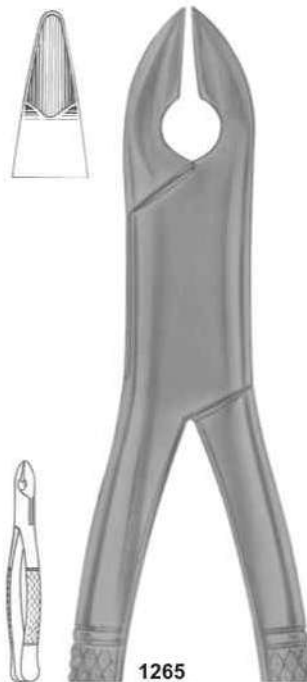

1265
KELLS
Fig. 99C
upper incisors,
canines, premolars



1268
CRYER
Fig. 150
lower incisors,
premolars, roots



1269
CRYER
Fig. 150A
upper incisors,
premolars, roots



1271
CRYER
Fig. 151
lower incisors,
premolars, roots



1272
CRYER
Fig. 151A
lower incisors,
premolars, roots



1270
CRYER
Fig. 150S
upper teeth for children

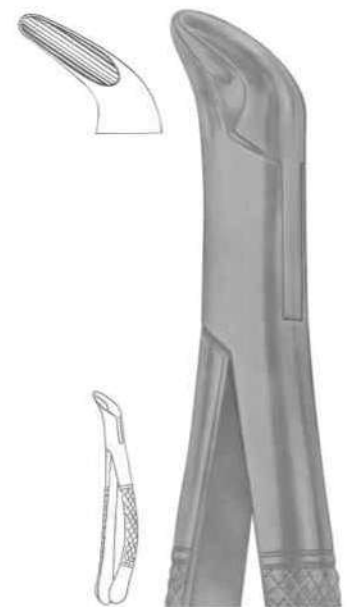

1273
CRYER
Fig. 151S
lower teeth
for children



1274
Fig. 203
lower incisors
and roots



1275
Fig. 210S
upper third molars

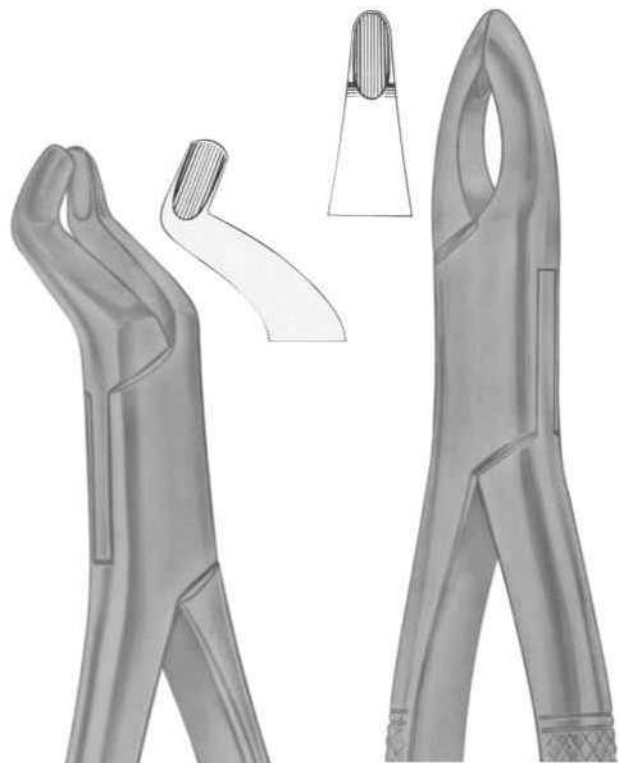

1278
Fig. 213
upper centrals and canines



1276
Fig. 201
upper incisors,
canines, premolars



1277
Fig. 210H
upper third molars



1279
Fig. 217
lower molars

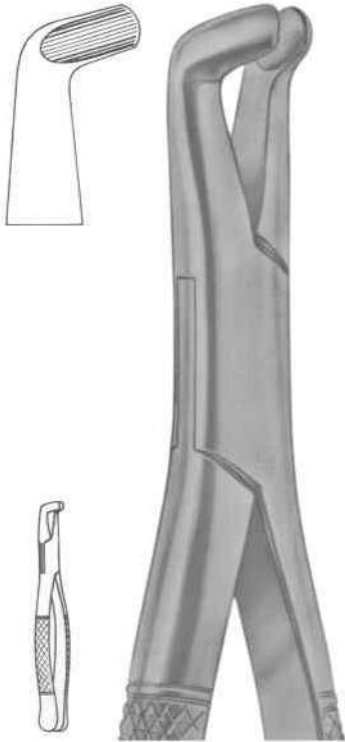

1280
Fig. 222
lower third molars



1282
Fig. 286
Swing lower molars



1283
Fig. 288
lower canines
and premolars

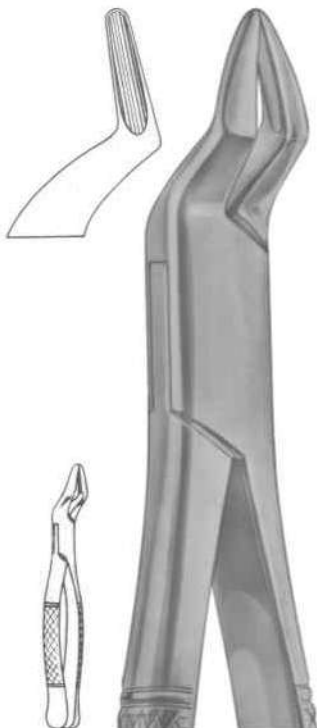

1281
Fig. 286
upper incisors and roots



1284
COHEN
Fig. 310
universal forceps

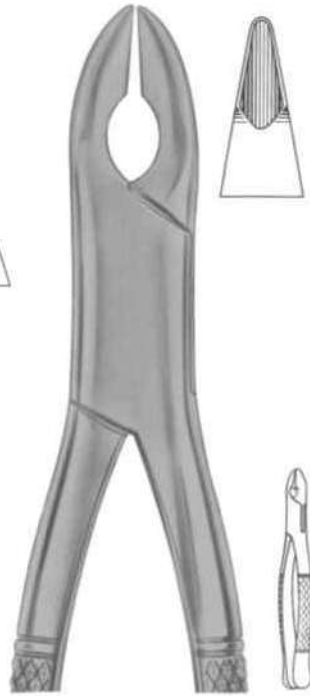

1285
NEVIUS
Fig. 320/10S
upper canines



1287
NEVIUS
Fig. 325/10H
upper canines



1288
STANDARD
Fig. 330/4
upper third molars

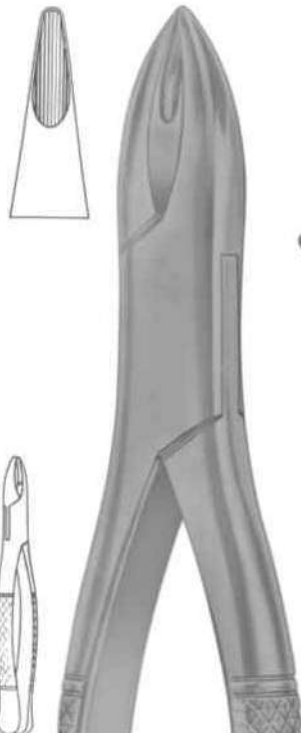

1286
HENAHAN
Fig. 315/1A
upper incisors





1289
WOODWARD
Fig. 335/FH
lower molars

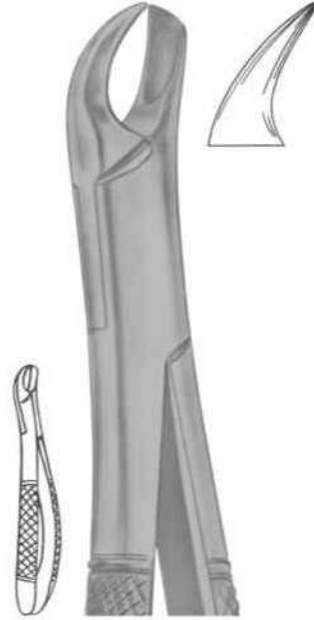

1290
Fig. 340/89
upper molars right

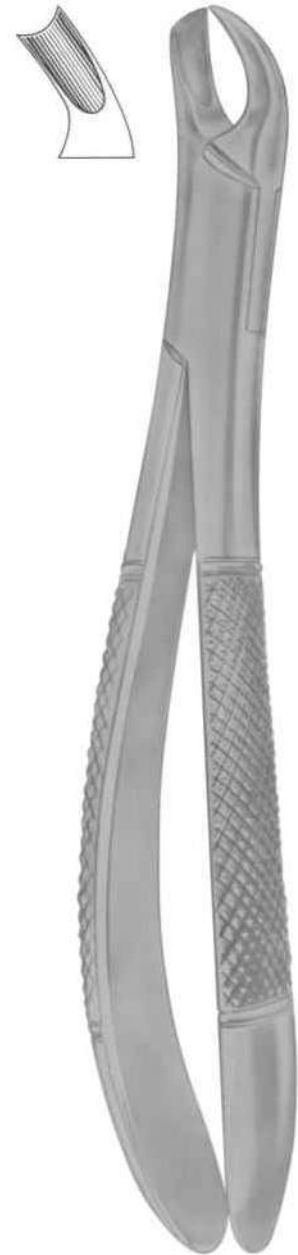

1292
Fig. 345/90
upper molars left

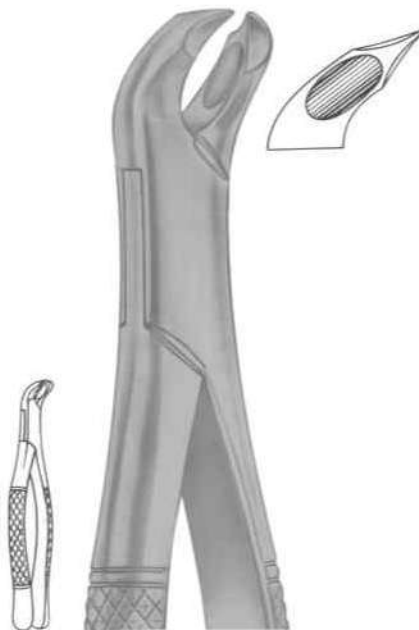

1291
WOODWARD
Fig. 335/FS
lower molars



1293
Fig. 350/23S
lower molars

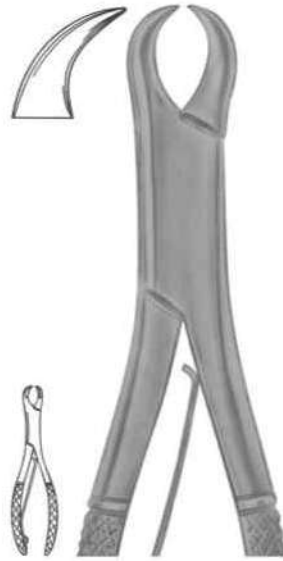

1294
Fig. 355/23SK
lower molars



1295
Forcep Fig. 301



1295-A
Forcep Fig. 300



1296
Fig. 360/17SK
lower molars



1297
Fig. 365/150SK
upper anteriors
and roots



1298
Fig. 370/151SK
lower anteriors
and roots



1299
Molt 9



1300
Allen 9A



1301
Prichard



1302
Seldin



1303
Goldman-Fox 14



1304
West
Dell W2

Heidbrink Root - Tip Picks

Root Tip



1305
DEL 78



1306
DEL 79



1307
DEL 80



1308
DEL H1



1309
DEL H2



1310
DEL H3



1311
DEL H2-3



1312
POTT
6X



1313
POTT
7X



1314
BUSER



1315
OHI 10



1316
HOWARD 9H



1317
FREER



1318
FREER 15



1319
FREER 16

lower jaw, left side

lower jaw, right side



1320
BEIN
Fig. 4



1331



1332

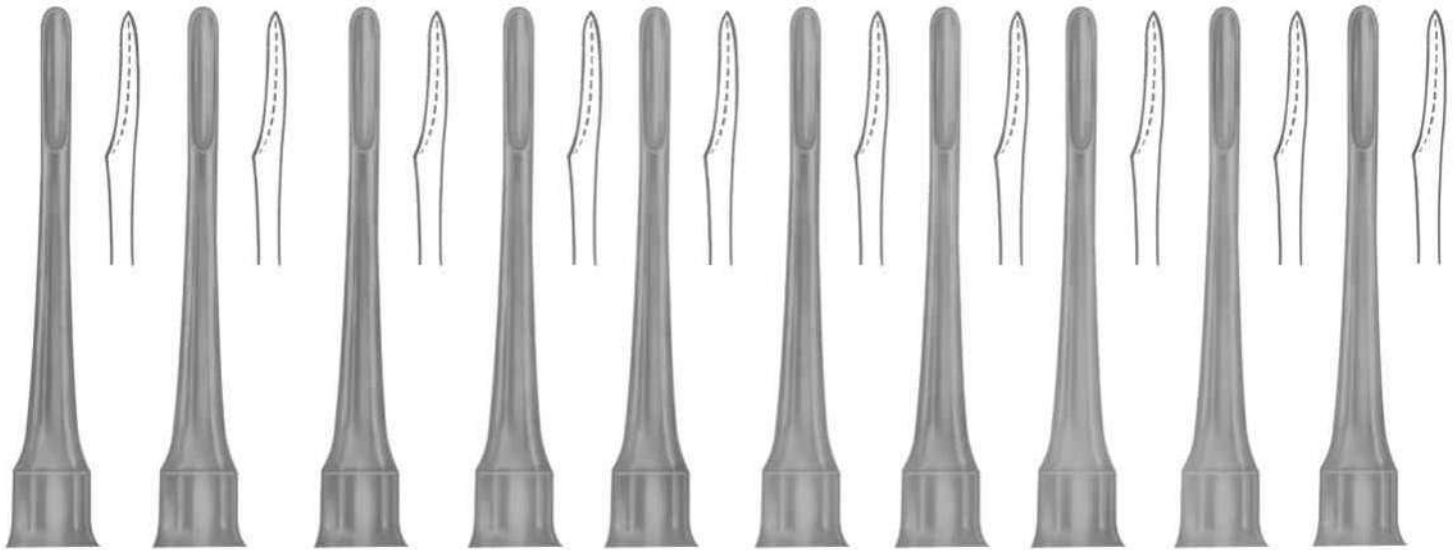

1321
BEIN
1.0 mm

1322
BEIN
1.5 mm

1323
BEIN
2.0 mm

1324
BEIN
2.5 mm

1325
BEIN
3.0 mm

1326
BEIN
3.5 mm

1327
BEIN
4.0 mm

1328
BEIN
4.5 mm

1329
BEIN
5.0 mm

1330
BEIN
5.5 mm



1334
BEIN
Fig. 1



1335
BEIN
Fig. 2



1336
BEIN
Fig. 0



1337
BEIN
Fig. 3



1333
BEIN



1338
BEIN
Fig. 4



1339
BEIN
Fig. 5



1340
BEIN
Fig. 6



1341
CRYER
Fig. 3



1342
CRYER
Fig. 4



1343
CRYER
Fig. 12



1344
CRYER
Fig. 27



1345
CRYER
Fig. 28



1346
CRYER
Fig. 27S



1347
CRYER
Fig. 28S



1348
SELDIN
Fig. 2



1349
SELDIN
Fig. 3



1350
SELDIN
Fig. 4L



1351
SELDIN
Fig. 4R



1352
SELDIN
Fig. 1L



1353
SELDIN
Fig. 1R



1354



1355



1356



1357

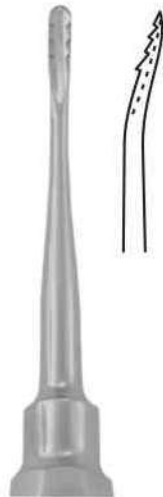

1358

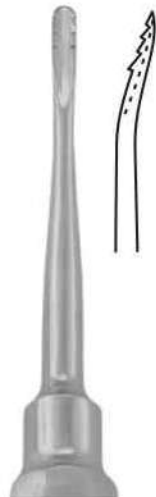

1359



1360



Root Screws



1362
Morrison
2.0 mm



1363
Morrison
2.5 mm



1364
Morrison
3.0 mm

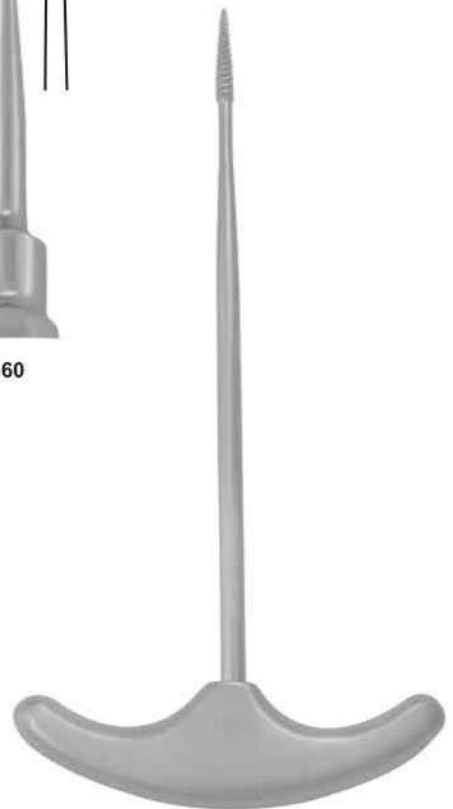

1361
Morrison
3.5 mm



1365
IS-APICAL



1366
APICAL
2 mm
Fig. 1



1367
APICAL
3 mm
Fig. 2



1368
APICAL
4 mm
Fig. 3



1369
APICAL
4.5 mm
Fig. 4



1370
APICAL
2 mm
Fig. 5



1371
APICAL
3 mm
Fig. 6



1372
APICAL
4 mm
Fig. 7



1373
APICAL
4.5 mm
Fig. 8



1374
APICAL
Fig. 9



1375
WINTER
Fig. 14 L



1376
WINTER
Fig. 14 R



1377
HEIDBRINK
Fig. 1



1378
HEIDBRINK
Fig. 2



1379
FLOHR
Fig. 1



1380
FLOHR
Fig. 2



1381
APICAL
Fig. 1



1382
APICAL
Fig. 2



1383
IS-CRYER



1384
CRYER
Fig. 1



1385
CRYER
Fig. 2



1386
IS-COUPLAND



1387
COUPLAND
Fig. 1



1388
COUPLAND
Fig. 2



1389
COUPLAND
Fig. 3



1390
Fig. 1



1391
Fig. 2



1392
Fig. 3



1393
FLOHR
Fig. 1



1394
FLOHR
Fig. 2

1395
FLOHR
Fig. 3



1396
KOPP
Fig. 1



1397
KOPP
Fig. 2



1403
KOPP
Fig. 1



1404
KOPP
Fig. 2



1396
KOPP



1398
KOPP
Fig. 3



1399
KOPP
Fig. 4



1402
KOPP



1405
KOPP
Fig. 3



1406
KOPP
Fig. 4



1400
KOPP
Fig. 5



1401
KOPP
Fig. 6

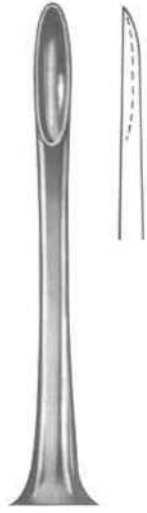

1407
HYLIN
Fig. 1



1409
BEIN
Fig. 1

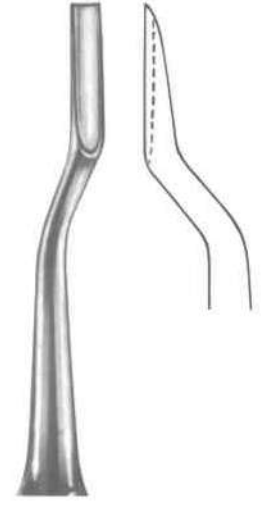

1410
BEIN
Fig. 2



1407
HYLIN



1408
HYLIN
Fig. 2



1409
BEIN

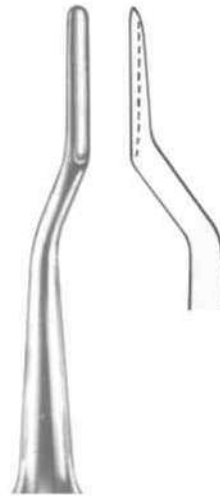

1411
BEIN
Fig. 3

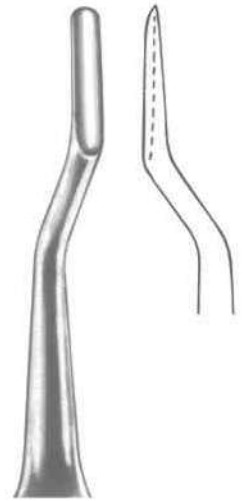

1412
BEIN
Fig. 4



1413
Warwick-James
Fig. 2

1413
WARWICK-JAMES
Fig. 1



1414
Warwick-James
Fig. 3



1415
London-Hospital
Fig. 1



1415
London-Hospital
Fig. 2



1416
London-Hospital
Fig. 3

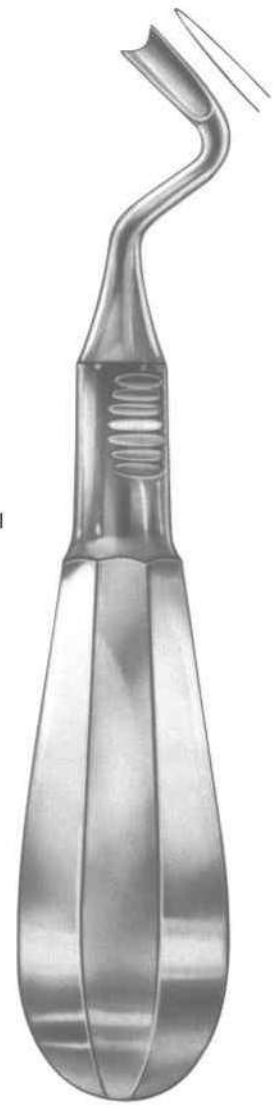

1417
OTT



1418
CHOMPRET
Fig. 1



1419
CHOMPRET
Fig. 2



1420
CHOMPRET
Fig. 3



1421
CHOMPRET
Fig. 4



1423
Fig. 1



1422
Fig. 2

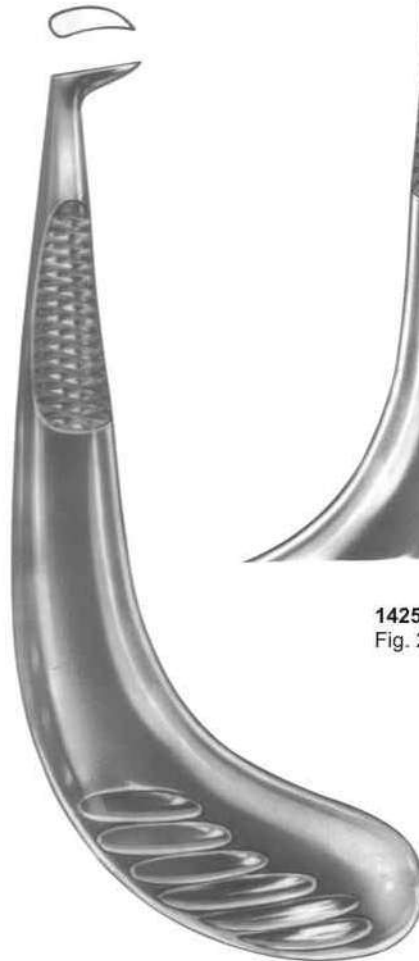

1424
Fig. 1



1425
Fig. 2



1426
APICAL



1427
IS-Fig. 1



1428
Fig. 2



1429
Fig. 3



1430
HEIDBRINK
Fig. 1



1431
HEIDBRINK
Fig. 2



1432
HEIDBRINK
Fig. 3



1438
MEAD
MD1



1433
LECLUSE



1434
MEAD
MD-5 A



1435
MEAD
MD-6 A



1436
MEAD
MD-7 A



1437
MEAD
MD-8



1439
WINTER
Fig. 1L



1440
WINTER
Fig. 1R



1441
WINTER
Fig. 2L



1442
WINTER
Fig. 2R

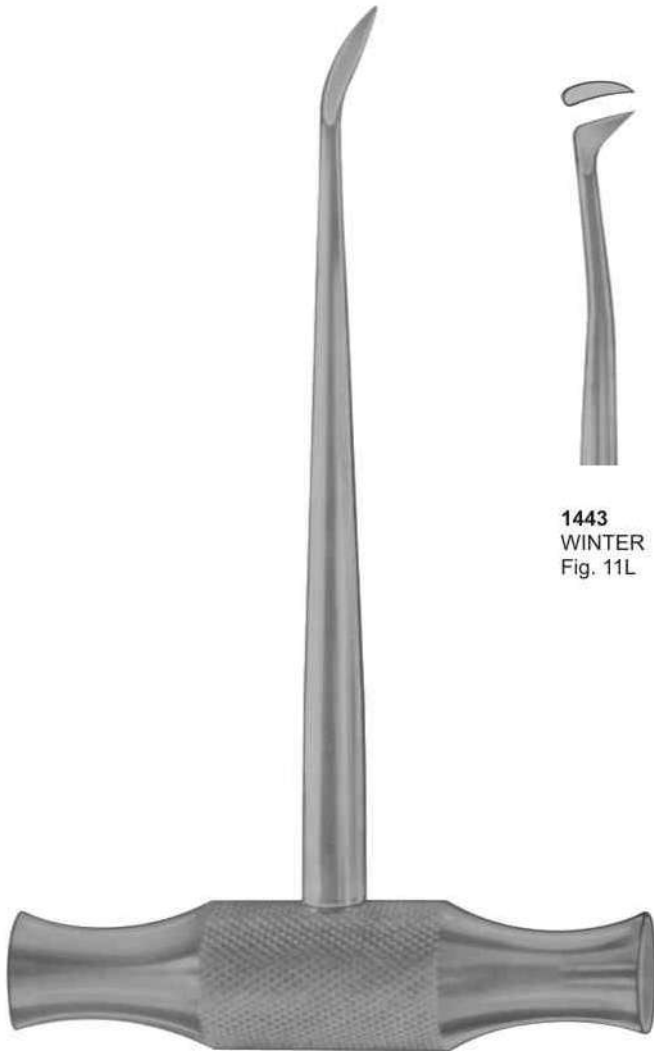

1439
WINTER



1443
WINTER
Fig. 11L



1444
WINTER
Fig. 11R



1445
WINTER
Fig. 12L



1446
WINTER
Fig. 12R



1447
WINTER
Fig. 14L



1448
WINTER
Fig. 14R



1449
BARRY
Fig. 1



1450
BARRY
Fig. 2



1451
BARRY
Fig. 3



1452
BARRY
Fig. 4



1449
BARRY



1453
BARRY
Fig. 11



1454
BARRY
Fig. 12



1455
BARRY
Fig. 17



1456
BARRY
Fig. 18



1458
CRYER
Fig. 26



1459
SELDIN
Fig. 27



1460
CRYER
Fig. 28



1461
CRYER
Fig. 29



1462
HEIDBRINK
Fig. 22



1463
HEIDBRINK
Fig. 23

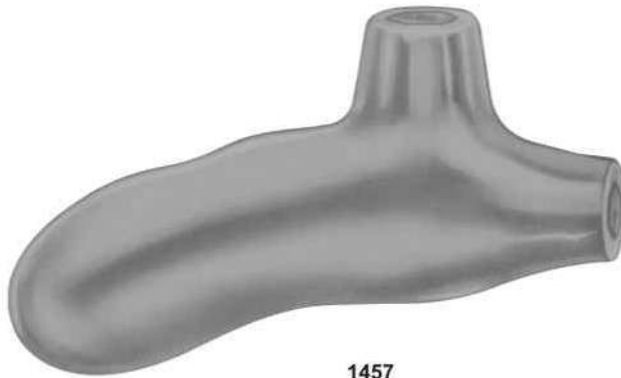

1457



1465
KOPP
Fig. 31



1466
KOPP
Fig. 32



1467
KOPP
Fig. 33



1468
KOPP
Fig. 34



1469
KOPP
Fig. 35



1470
KOPP
Fig. 44

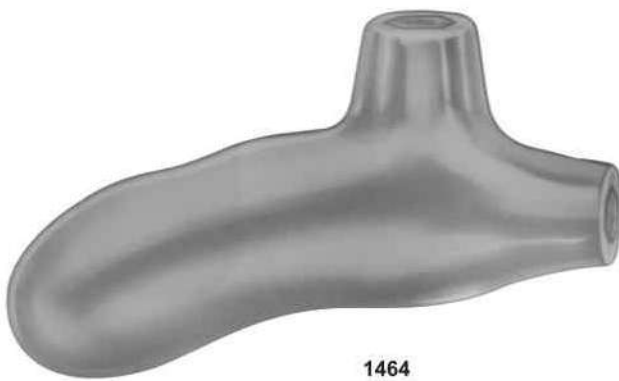

1464



1472
HEIDBRINK
Fig. 10



1473
WINTER
Fig. 11



1474
WINTER
Fig. 12



1475
BARRY
Fig. 17



1476
BARRY
Fig. 18



1477
BARRY
Fig. 20



1471

Root Elevators according to Dr. Sader,
with interchangeable working tips

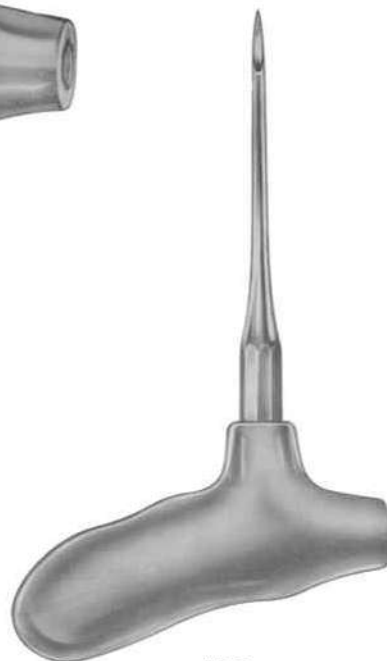

1478



1479



1480

1481
Root Elevator, Plastic Handle, Set of 10 Pcs

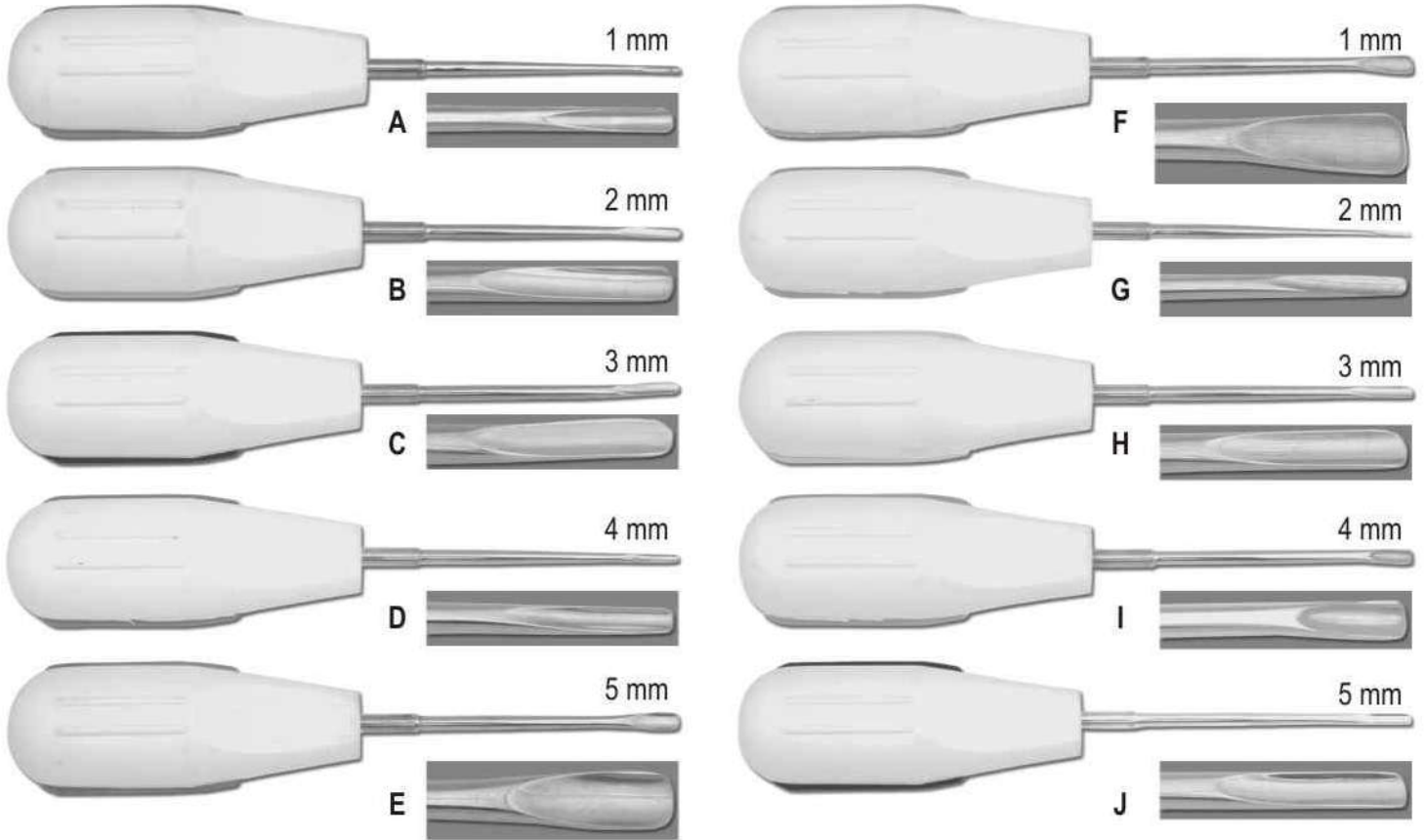

1482
Root Elevator, Plastic Handle, Set of 5 Pcs

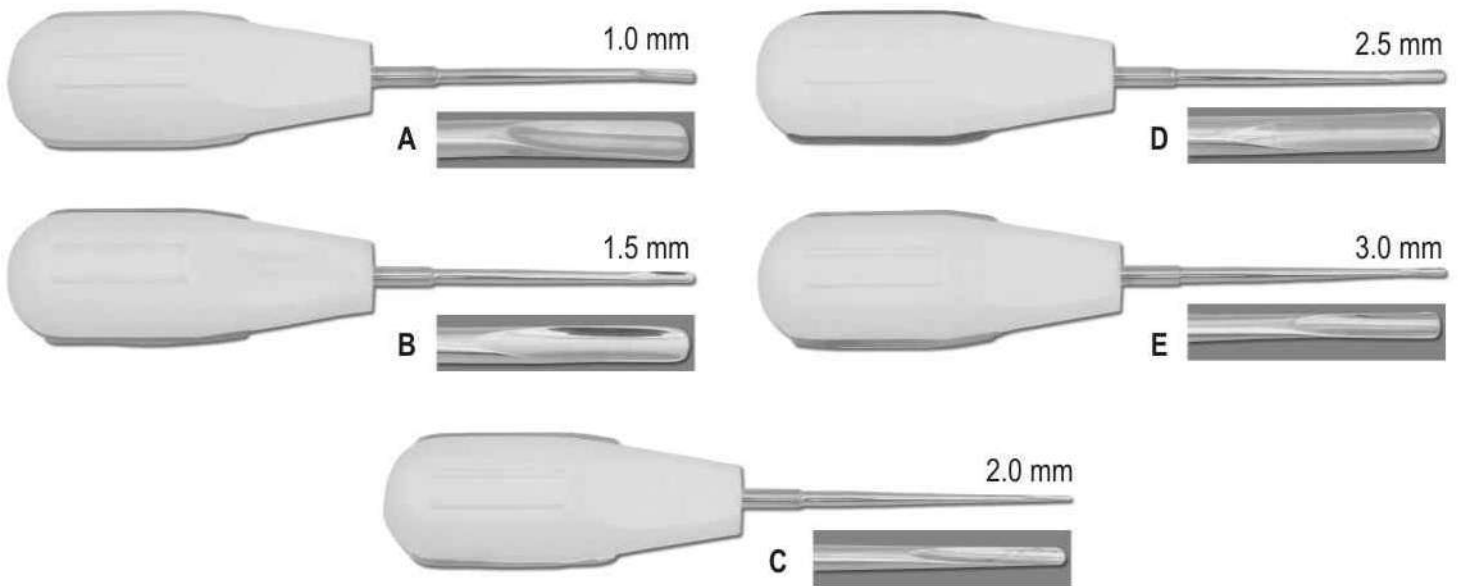

- ⟨☞⟩ Scalpel Handles
- ⟨☞⟩ Mouth Mirrors and Handles
- ⟨☞⟩ Explorer and Probes
- ⟨☞⟩ Endodontics
- ⟨☞⟩ Excavators



02

SECTION





1483
Scalpel Handle Angle Of Blade Adjusts To Easily Get Around Corners
Adjustment Sets Blade From Straight To Back Angled
Locks In At 90°, 60°, 30°, Straight, -30°, -60° Angles



1484
Scalpel Handle
Fig. 5



1485
Scalpel Handle
Curved



1486
Fig. 3L



1487
Fig. 7



1488
Scalpel Handle
Fig. 4L, Curved
20 cm



1489
Fig. 3



1490
Fig. 3G



1491
Fig. 4



1492



1493
Scalpel Handle
4 D 14.0 cm



1494
Mess Holders



1495
Gouge
Blade Handle
Fig. 2 / 11.5 cm

Handle For Mouth Mirrors, Probes, Explorers, Excavators, Carvers, Curettes & Scalars



1496

Handle No. 2 Standard Single Ended



1497

Handle Single Ended



1498

Handle Single Ended



1499

Handle Single Ended

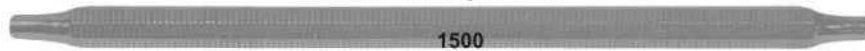

1500

Octagonal Double Ended



1501

Octagonal Double Ended



1502

Octagonal Double Ended



1503

Handle No. 2 (Standard Double Ended)



1504

Octagonal Double Ended



1505

Tactile Tone Double Ended



1506

Tactile Tone Double Ended



1507

Tactile Tone Double Ended



1508

Handle, Double Ended



1509

Double Ended



1510

Tactile Tone Double Ended



1511

Tactile Tone Double Ended

Mouth Mirrors

Plane



1514
Fig.6
Ø26 mm

1515
Fig.5
Ø24 mm

1516
Fig.4
Ø22 mm

Magnifying



1517
Fig.6
Ø26 mm

1518
Fig.5
Ø24 mm

1519
Fig.4
Ø22 mm

Front surface



1520
Fig.6
Rhodium
Ø26 mm
Front surface

1521
Fig.5
Rhodium
Ø24 mm
Front surface

1522
Fig.4
Rhodium
Ø22 mm
Front surface

Plane



1523
Fig.6
Ø26 mm

1524
Fig.5
Ø24 mm

1525
Fig.4
Ø22 mm

Magnifying



1526
Fig.6
Ø26 mm

1527
Fig.5
Ø24 mm

1528
Fig.4
Ø22 mm

With cone - socket

Mouth Mirrors,

Magnifying	1513-A
Plain	1512-B
Fig. 00	Ø 8 mm
Fig. 0	Ø 10 mm
Fig. 1	Ø 14 mm
Fig. 2	Ø 16 mm
Fig. 3	Ø 18 mm
Fig. 4	Ø 20 mm
Fig. 5	Ø 22 mm
Fig. 6	Ø 24 mm
Fig. 7	Ø 26 mm
Fig. 8	Ø 28 mm
Fig. 9	Ø 30 mm
Fig. 10	Ø 32 mm

1513-A



1512
Hollow Handle
Fig.1



1513
Hollow Handle
Fig.2





1529



1530



1531



1532



1533



1534



1535
Parallelometer
mouth mirror

1536
Parallelometer
mouth mirror
+ handle
code 2101



1537
Tactile Tone
Single Ended



1538
Handle
Thompson
Single Ended



1539
Hollow Handle



1540
Hollow Handle
Stainless
Steel



1541
Cone-socket
Hollow Handle



1542
Hollow Handle



1543
Hollow Handle

SCALERS - JAQUETTE

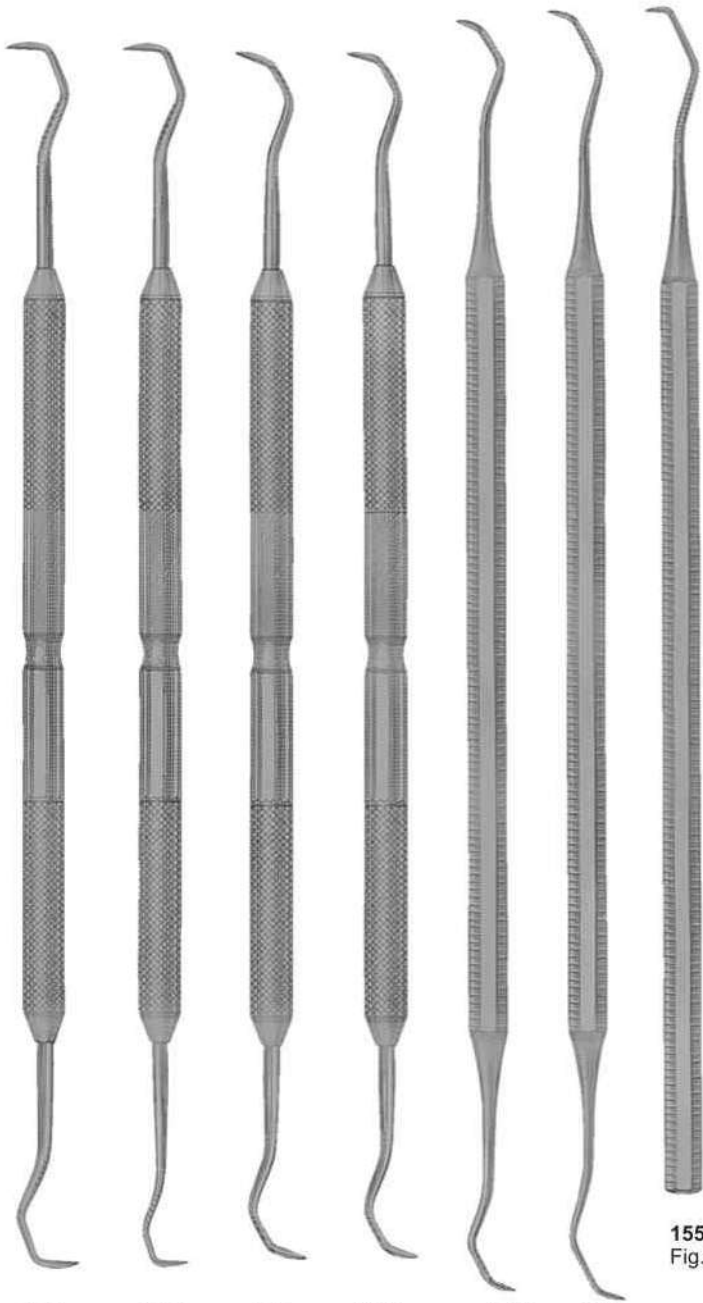

1544 1Y-1Y
1545 1Y-1YS
1546 2Y-3Y
1547 2YS-3YS
1548 2-3
1549 2S-3S

1550
Fig.1

SCALERS - OCTAGONAL

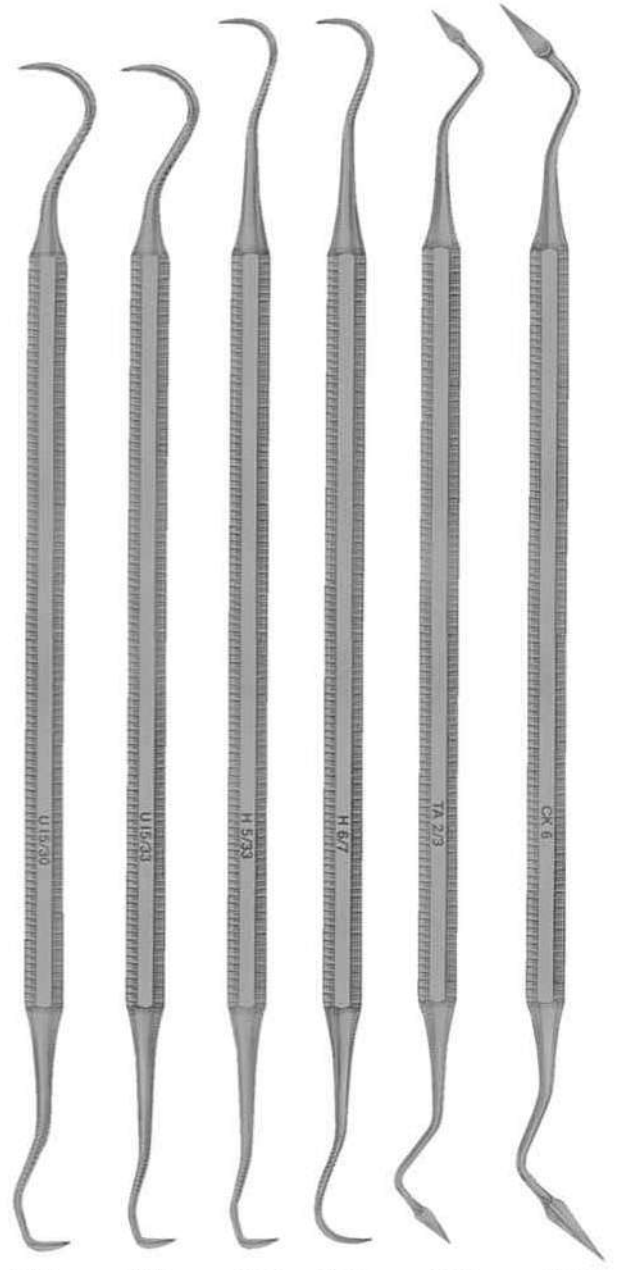

1551 U15-30
1552 U15-33
1553 H5-33
1554 H6-7
1555 Taylor 2-3
1556 CK6

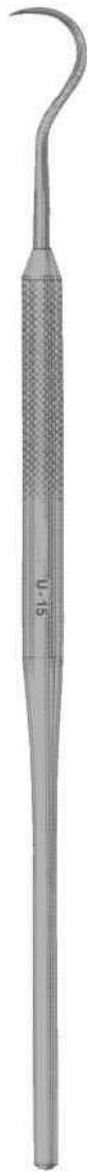

1557
U15



1558
No. 3



1559
No. 12



1560
WHITESIDE 1-0

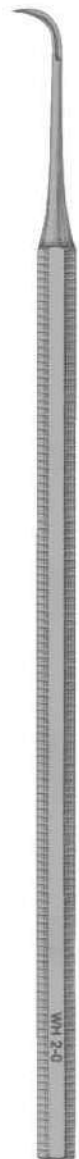

1561
WHITESIDE 2-0



1562
YAOUNGER/GOOD
7-8



1563
H5-33



1564
204SD



1565
H6-7



1566
204S



1567
TOWNER/JAQUETTE
U15-30



1568
JAQUETTE (33-U15)



1569
JAQUETTE
2Y-3Y



1570
JAQUETTE
30-U15



1571
JAQUETTE
2YS-3YS

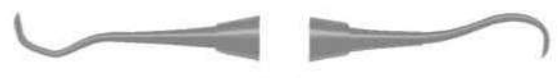

1572
JAQUETTE
33-H5



1573
YOUNGER/GOOD
7-8

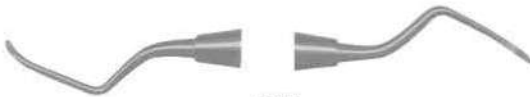

1574
204S

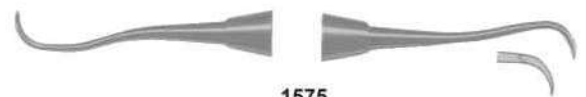

1575
204SD



1576
H6-7

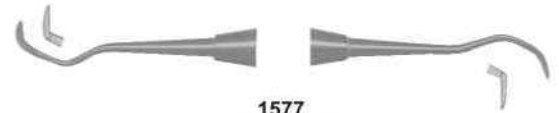

1577
JAQUETTE
2S-3S



1578
JAQUETTE
1Y-1YS



1579
JAQUETTE
2-3



1580
JAQUETTE (33-U15)



1581
S204



1583
S204S



1585
S204SD

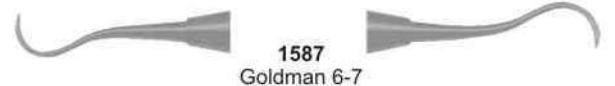

1587
Goldman 6-7

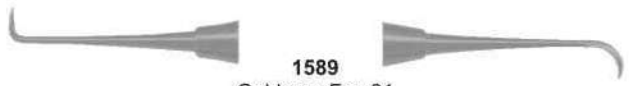

1589
Goldman Fox 21



1591
H5-U15



1593
Jaquette 34-35

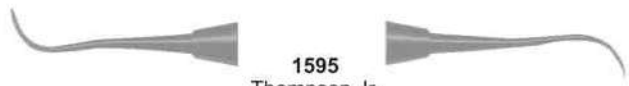

1595
Thompson Jr.



1597
UT107-108



1599
UP128



1582
Jack-Nebraska



1584
Jaquette 1-U15



1586
Jaquette 2-3



1588
Jaquette 2S-3S



1590
Jaquette 30-U15



1592
Jaquette 30-33



1594
Jaquette 31-32



1596
Jaquette 33-H5



1598
U 6-7



1600
128L

Explorers Double Ended - Octagonal

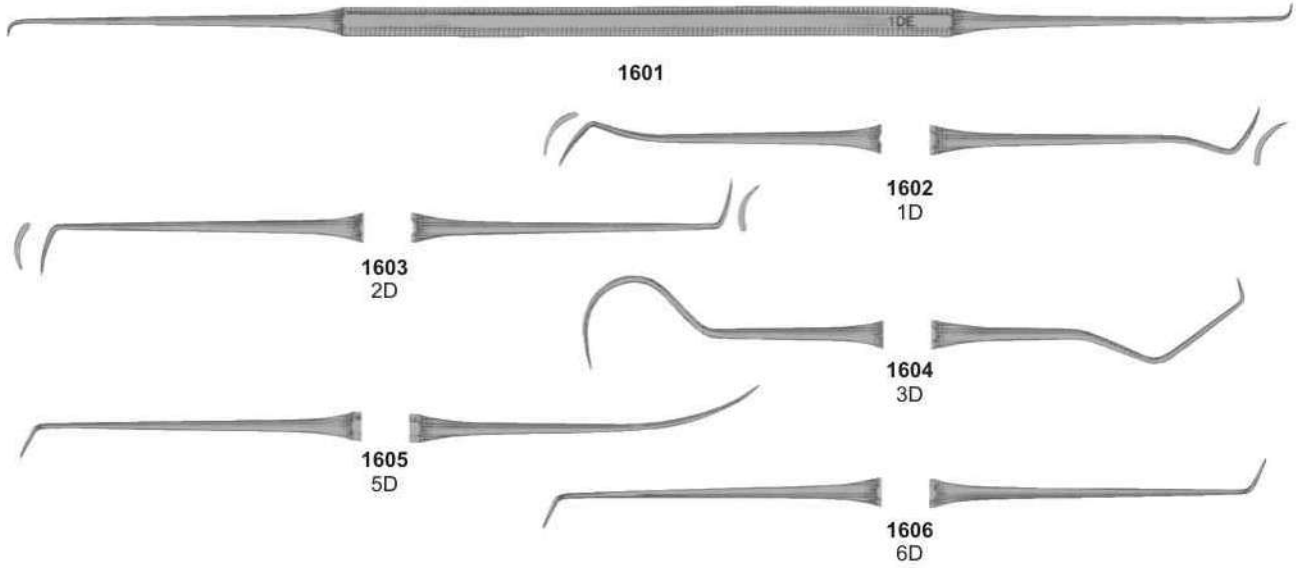

Explorers Double Ended - Standard

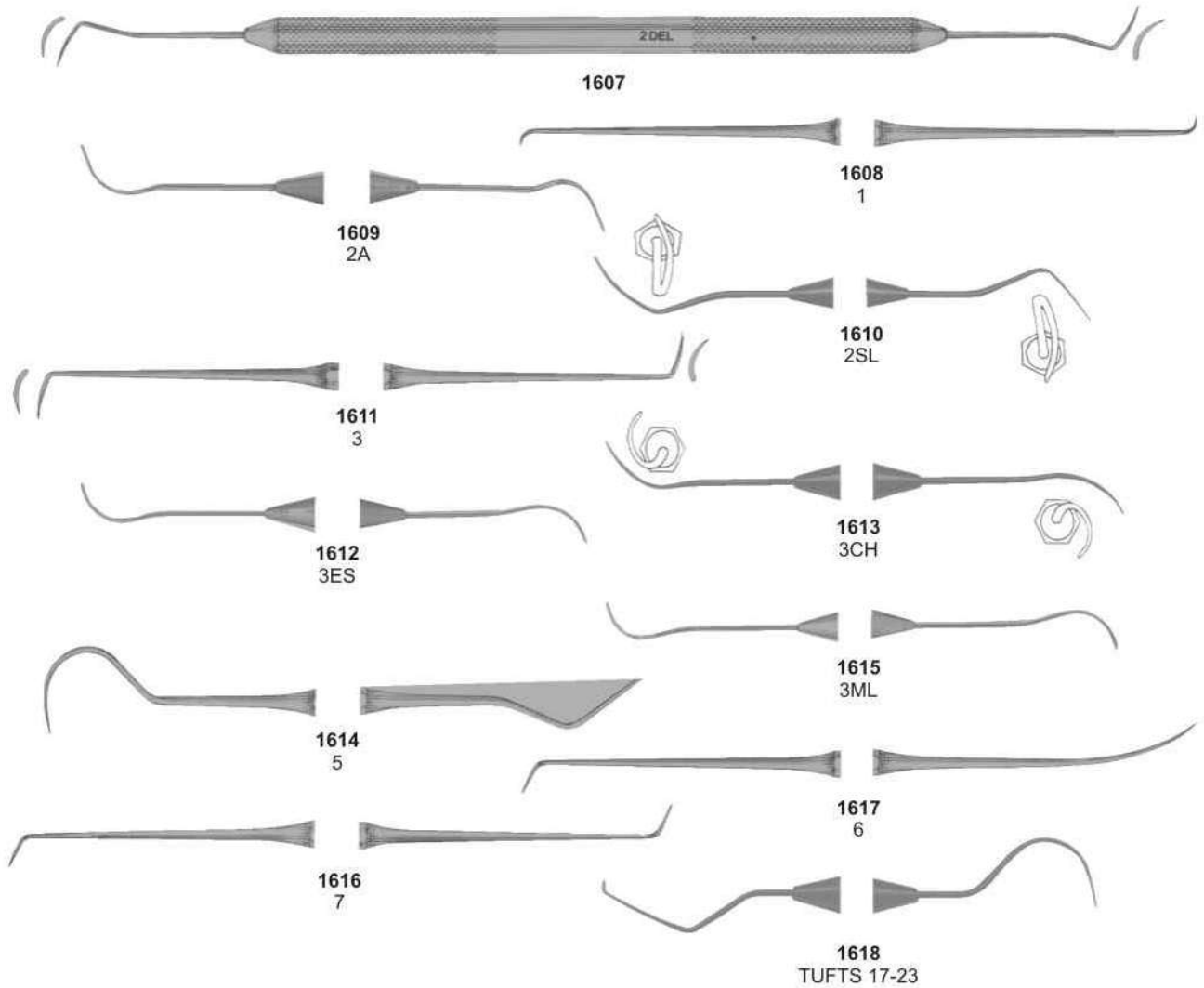

Explorers Double Ended Tactile Tone



1619
2A



1620
2



1621
1



1622
2SL

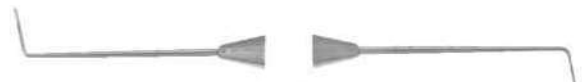

1623
3



1624
3CH



1625
3ES



1626
3ML



1627
5



1628
6

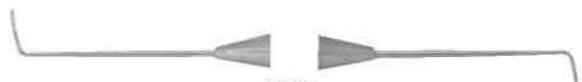

1629
7



1630
16



1631
TUFTS 17/23

Explorers Single Ended - Octagonal

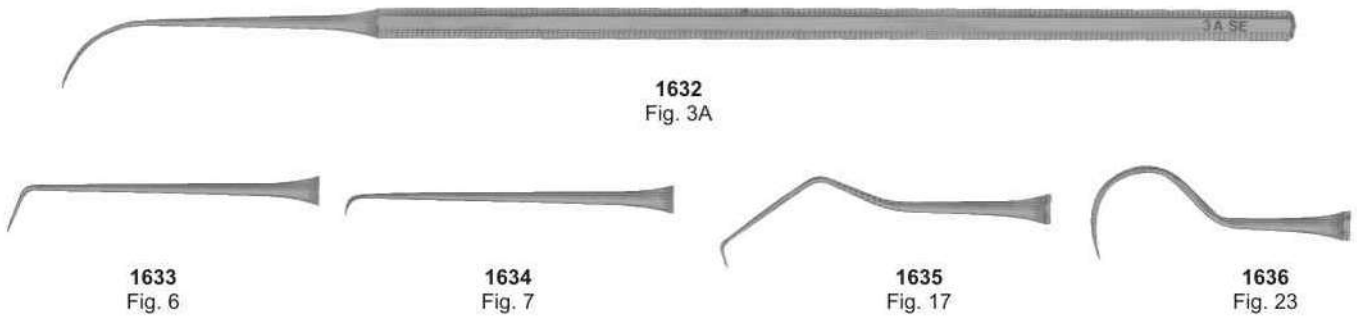

Explorers Single Ended - Standard

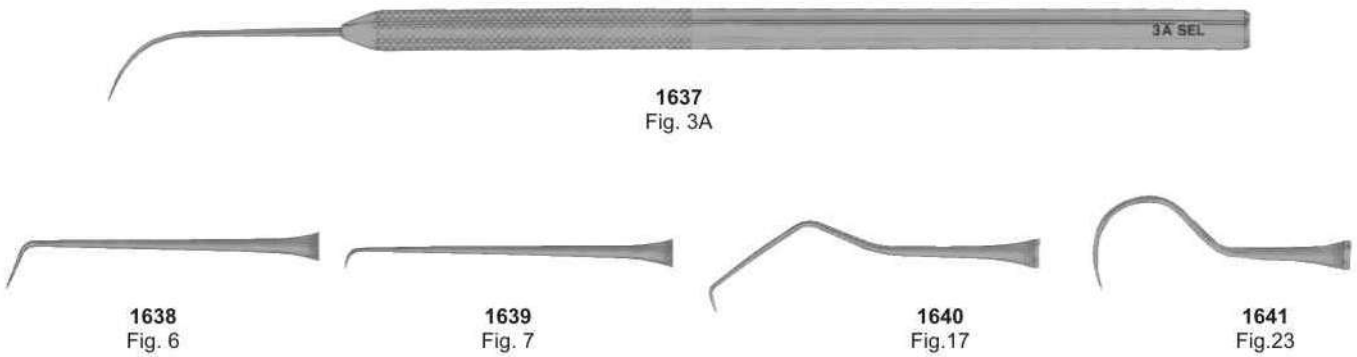

Probe / Explorer - Octagonal



Double Ended Probe - Octagonal

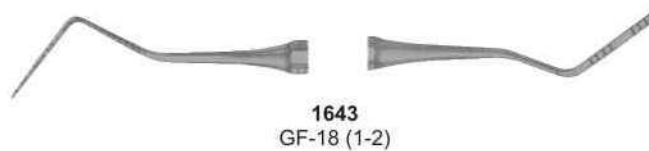

Probes Double Ended - Standard

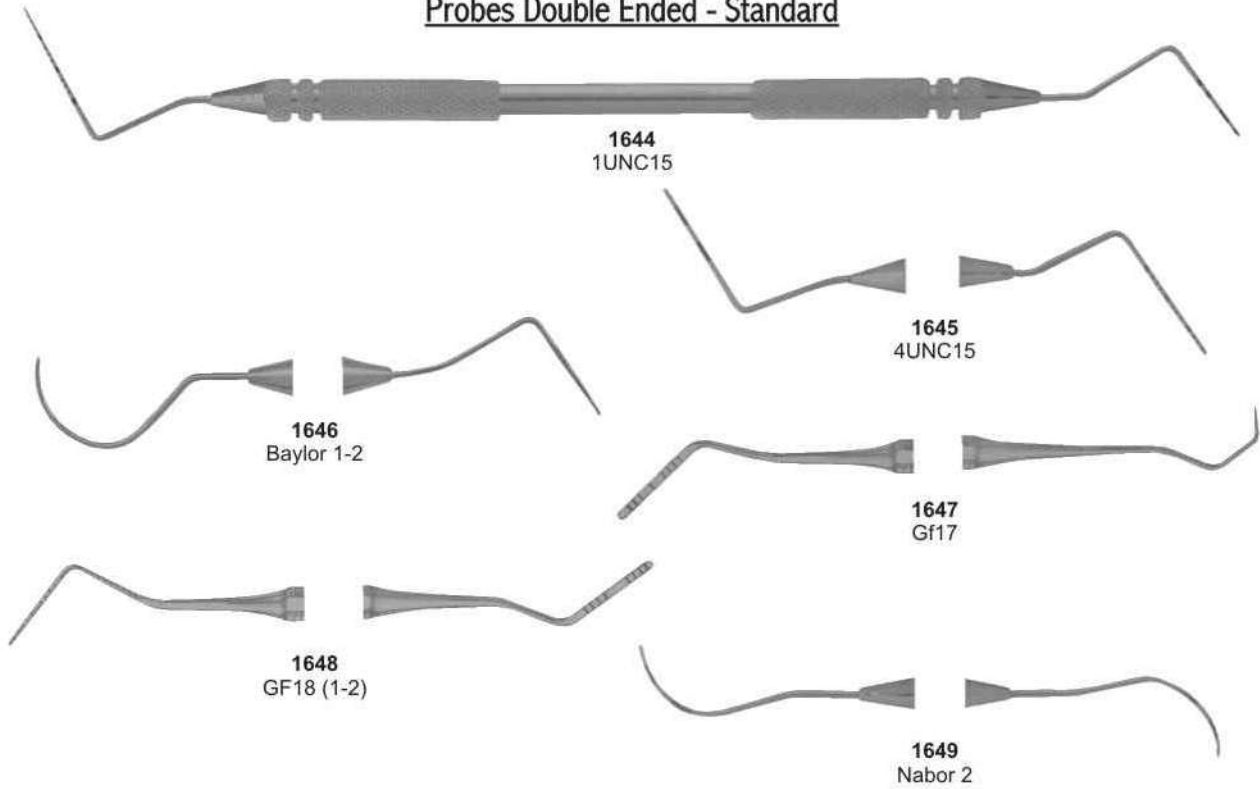

Probes Double Ended - Tactile Tone

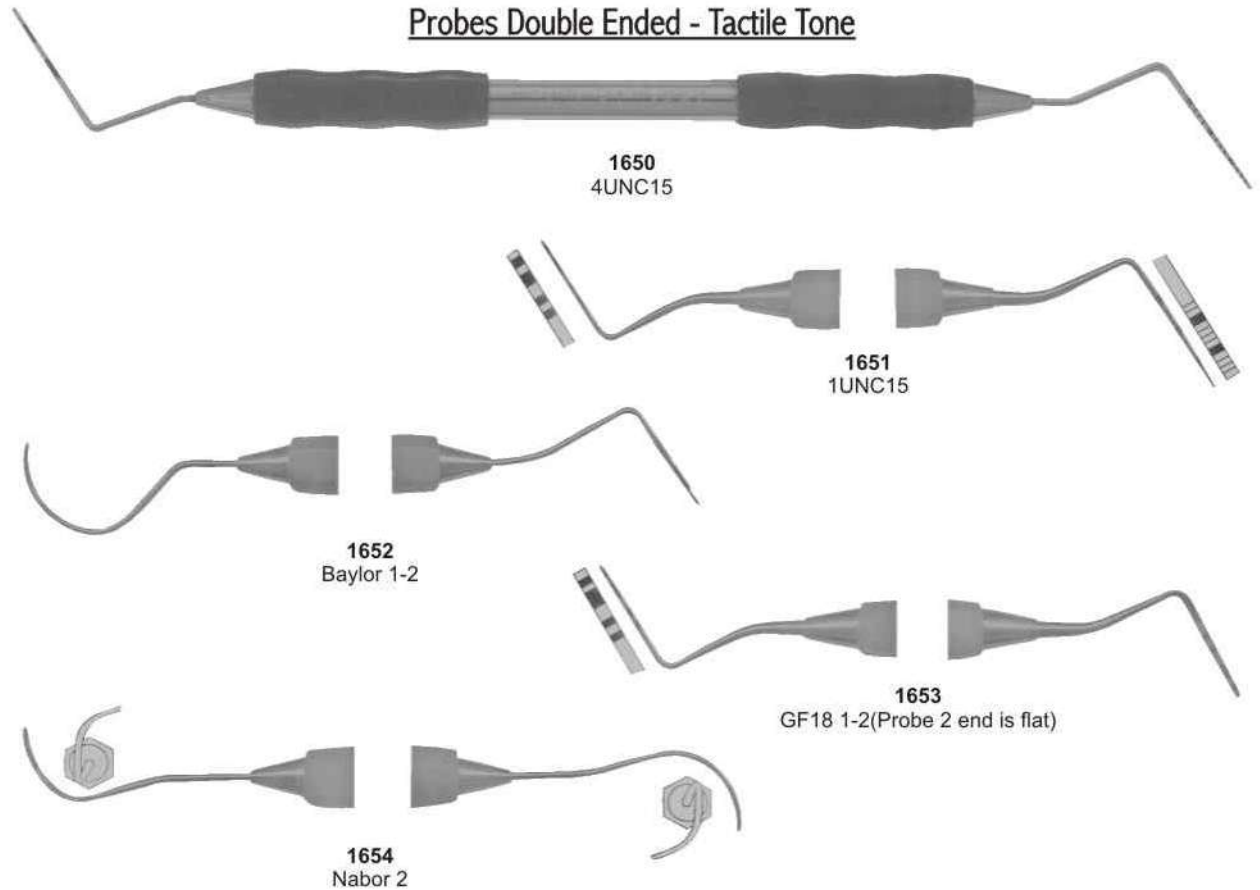

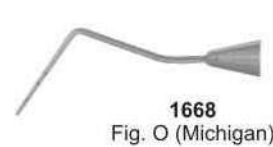
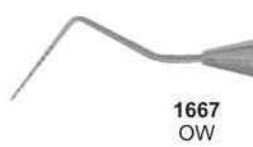
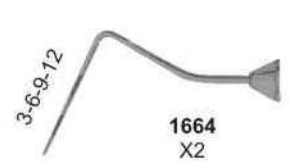
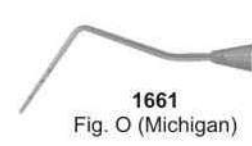
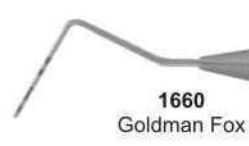
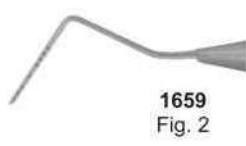
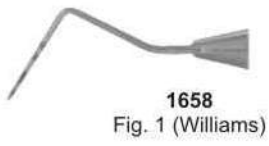
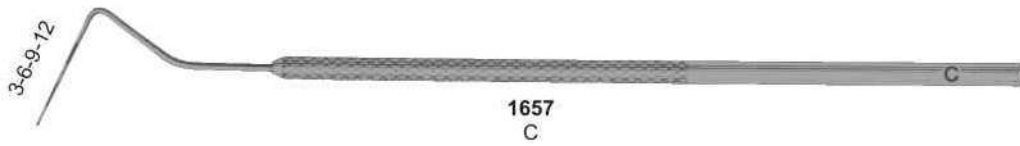
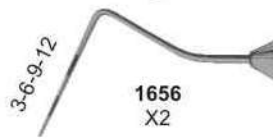
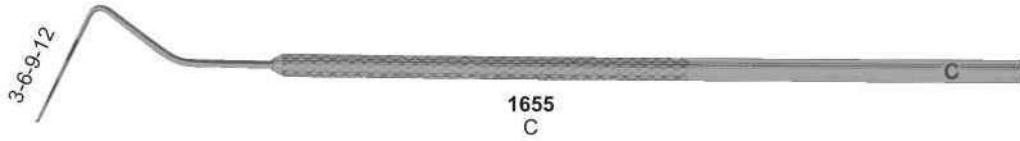

PROBES DOUBLE ENDED STANDARD

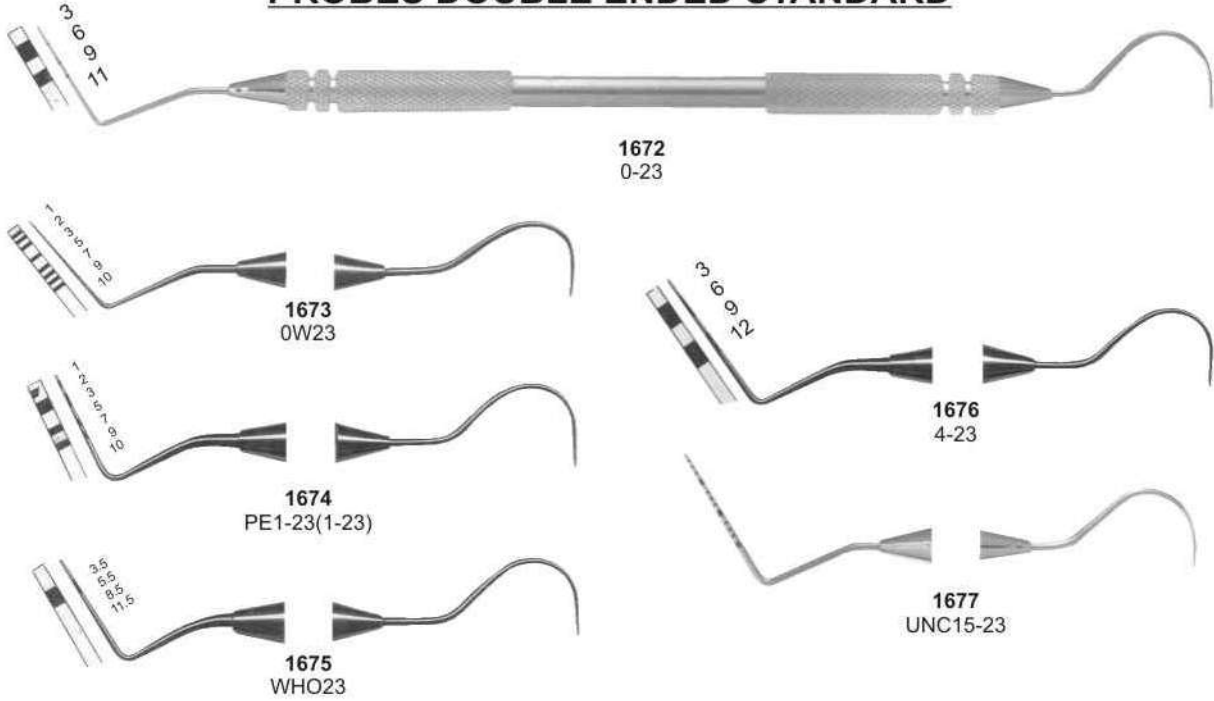

PROBES DOUBLE ENDED TACTILE TONE

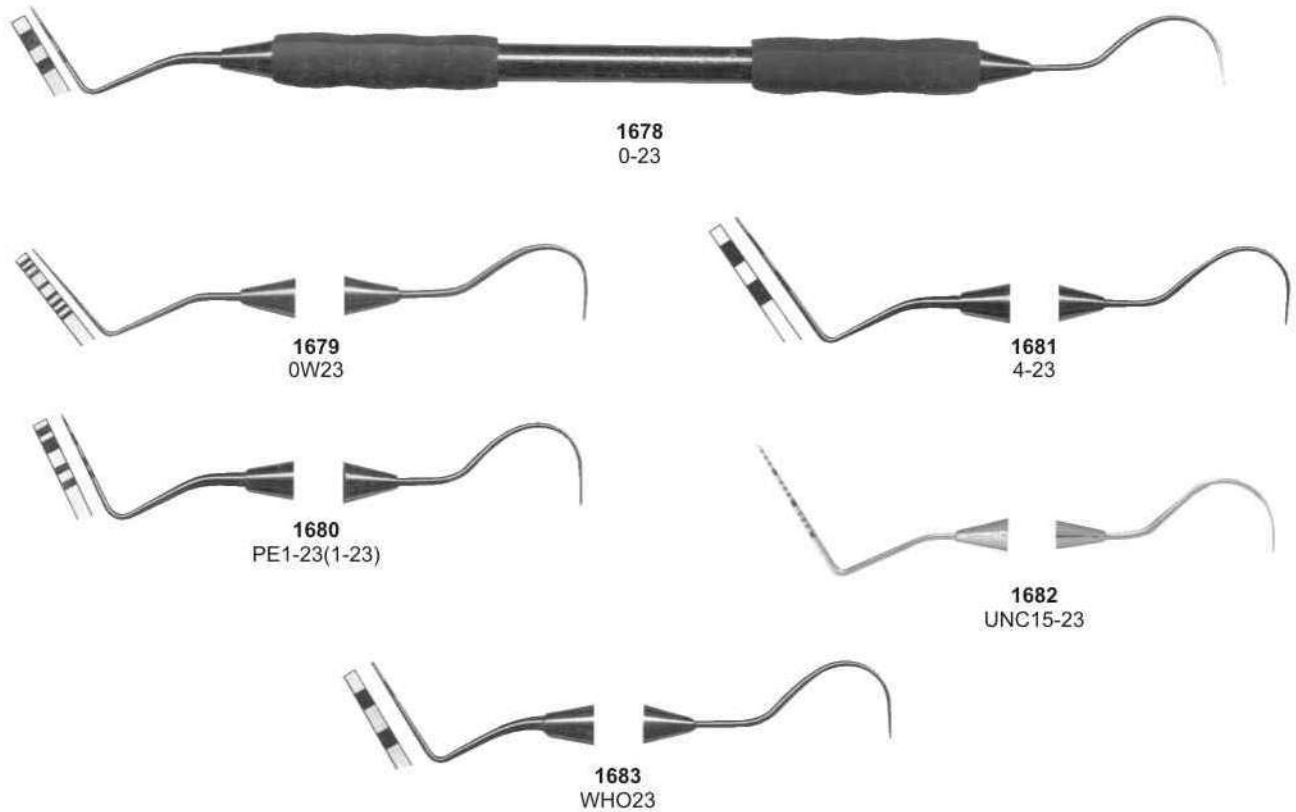

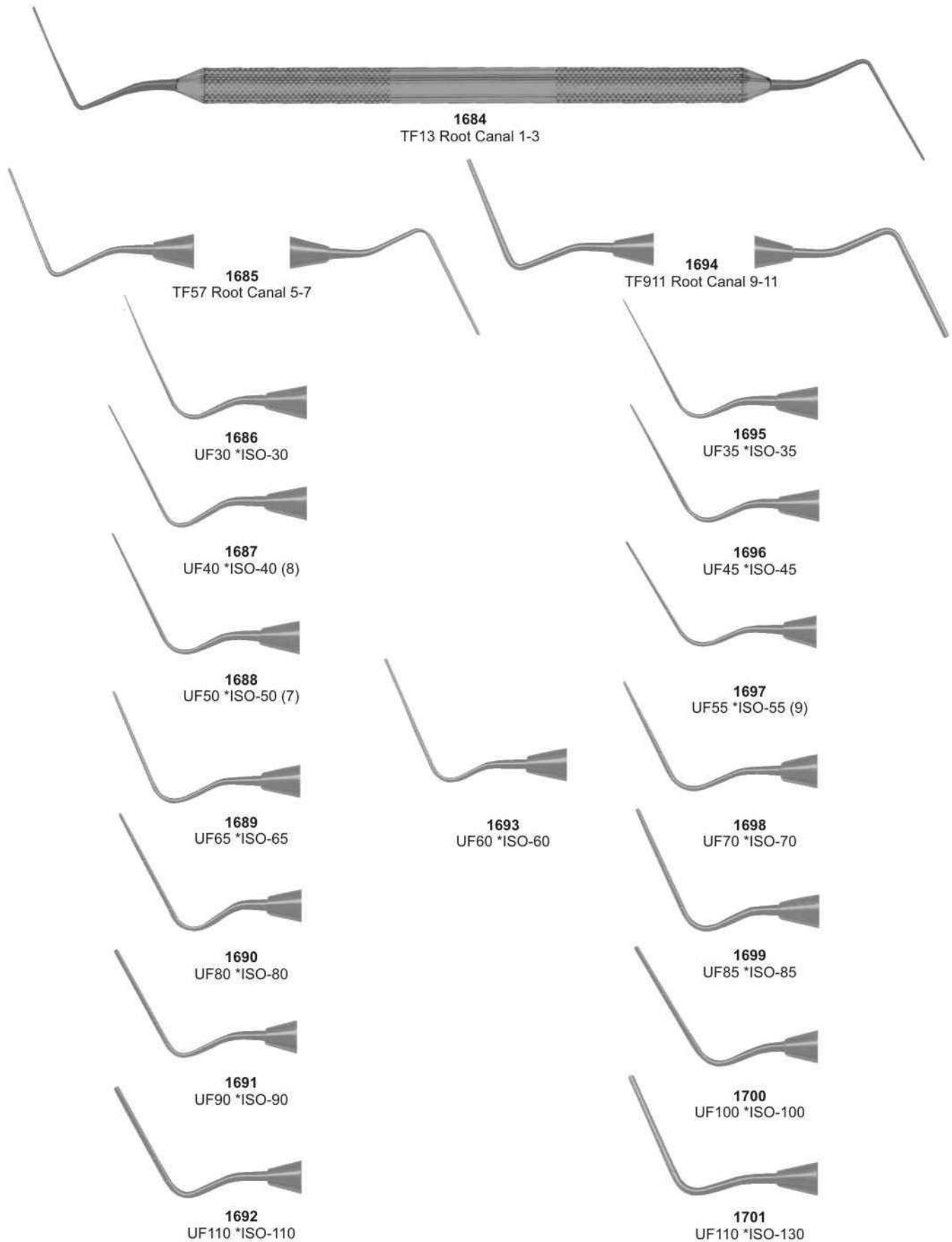



1702
UF120X



1703
UF45N



1704
UF60N



1705
UF80N



1706
UF100X



1707
UE25 R-25



1708
UE30 R-30



1709
UE35 R-35



1710
UE40 R-40



1711
UE45 R-45



1712
UE50 R-50



1713
UF120X



1714
UF140X



1715
TFD3545N



1716
TFD6080N



1717
UE55 R-55



1718
UE60 R-60



1719
UE25N R-25



1720
UE30N R-30



1721
UE40N R-40

1722
No. D11

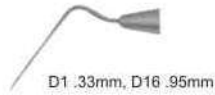

1723
No. D11T

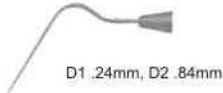

1724
No. KR1



1725
No. 25S

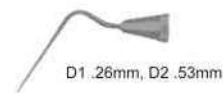

1726
No. W1S



1727
No. W2S

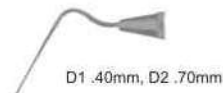

1728
Lucks No.1



1729
Lucks No.2



1730
Lucks No.3



1731
Lucks No.4

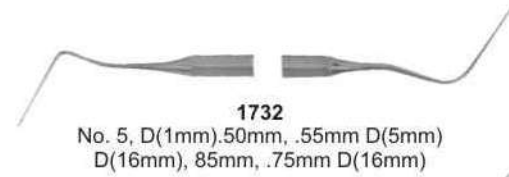

1732
No. 5, D(1mm).50mm, .55mm D(5mm)
D(16mm), 85mm, .75mm D(16mm)

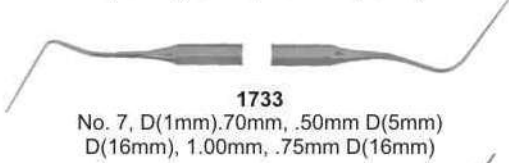

1733
No. 7, D(1mm).70mm, .50mm D(5mm)
D(16mm), 1.00mm, .75mm D(16mm)

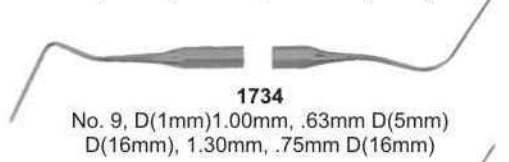

1734
No. 9, D(1mm)1.00mm, .63mm D(5mm)
D(16mm), 1.30mm, .75mm D(16mm)

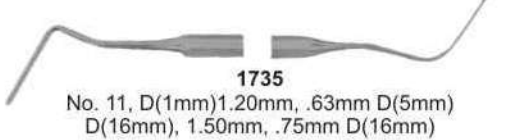

1735
No. 11, D(1mm)1.20mm, .63mm D(5mm)
D(16mm), 1.50mm, .75mm D(16mm)



1736
No.1 (D1 .35mm, D16 .75mm)



1737
No.2 D1 .55mm, D16 .85mm



1738
No.3 D1 .85mm, D16 1.15mm



1739
No.4 D1 1.00mm, D16 1.30mm

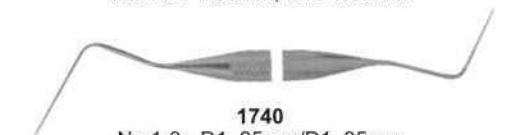

1740
No.1-3 - D1 .25mm/D1 .35mm

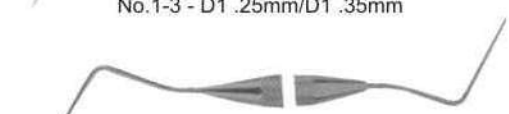

1741
No.3-5 - D1 .35mm/D1 .55mm



1742
No.5-7 - D1 .55mm/D1 .70mm



1743
No.9-11 - D1 1.00mm/D1 1.20mm

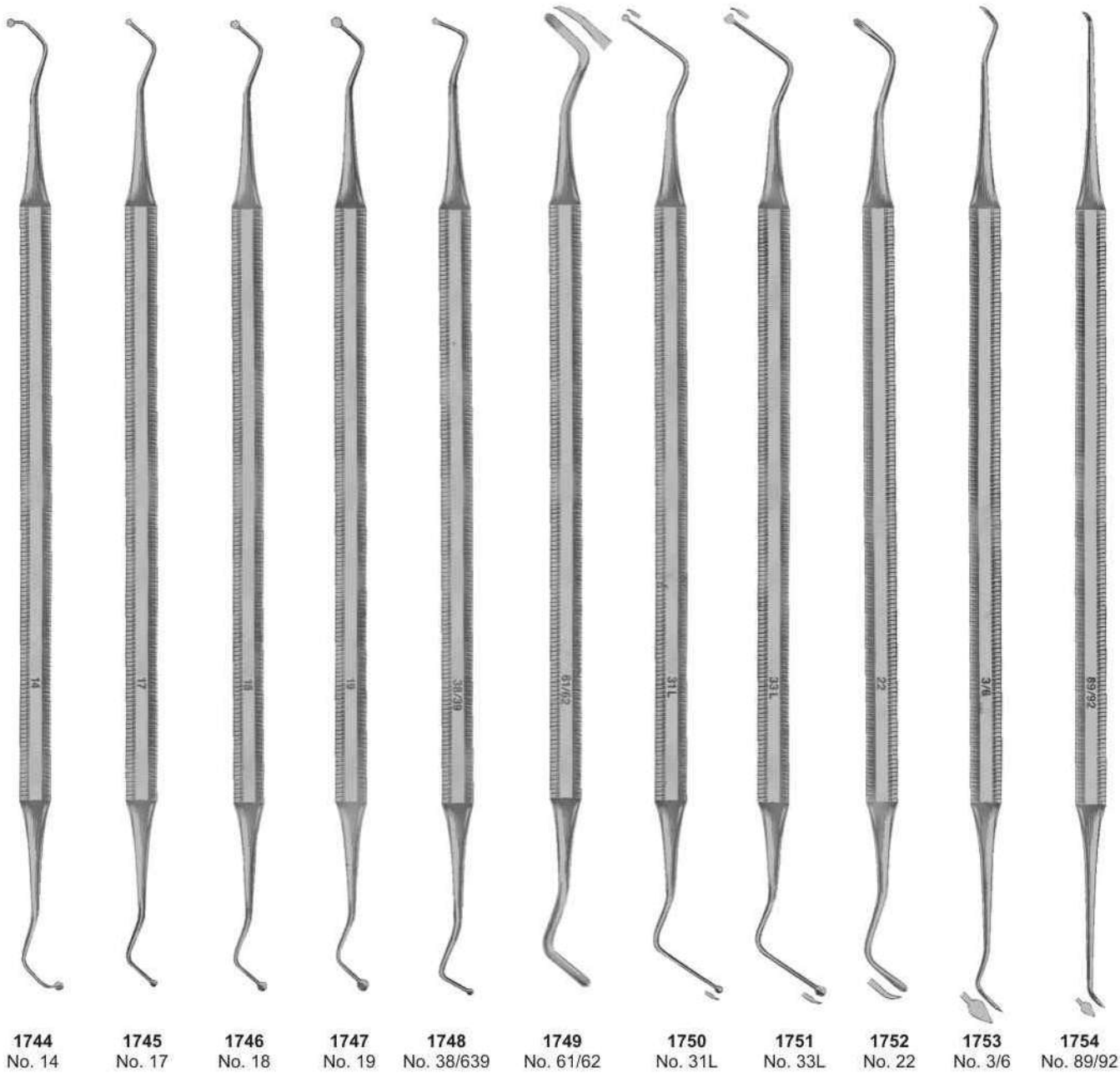

1744
No. 14

1745
No. 17

1746
No. 18

1747
No. 19

1748
No. 38/39

1749
No. 61/62

1750
No. 31L

1751
No. 33L

1752
No. 22

1753
No. 3/6

1754
No. 89/92

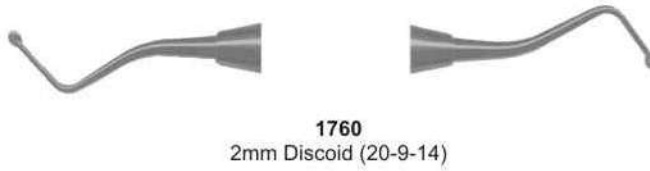

Excavators



1768
31L



1769
31W



1770
33L



1771
32L



Explorers / Probes



1772
G16D-L



1773
Explorer No.2



1774
Explorer No.16



1775
16-23 Explorer



1776
16-17 Explorer



1777
DG16 Explorer



1778
(Heavy DG-16)



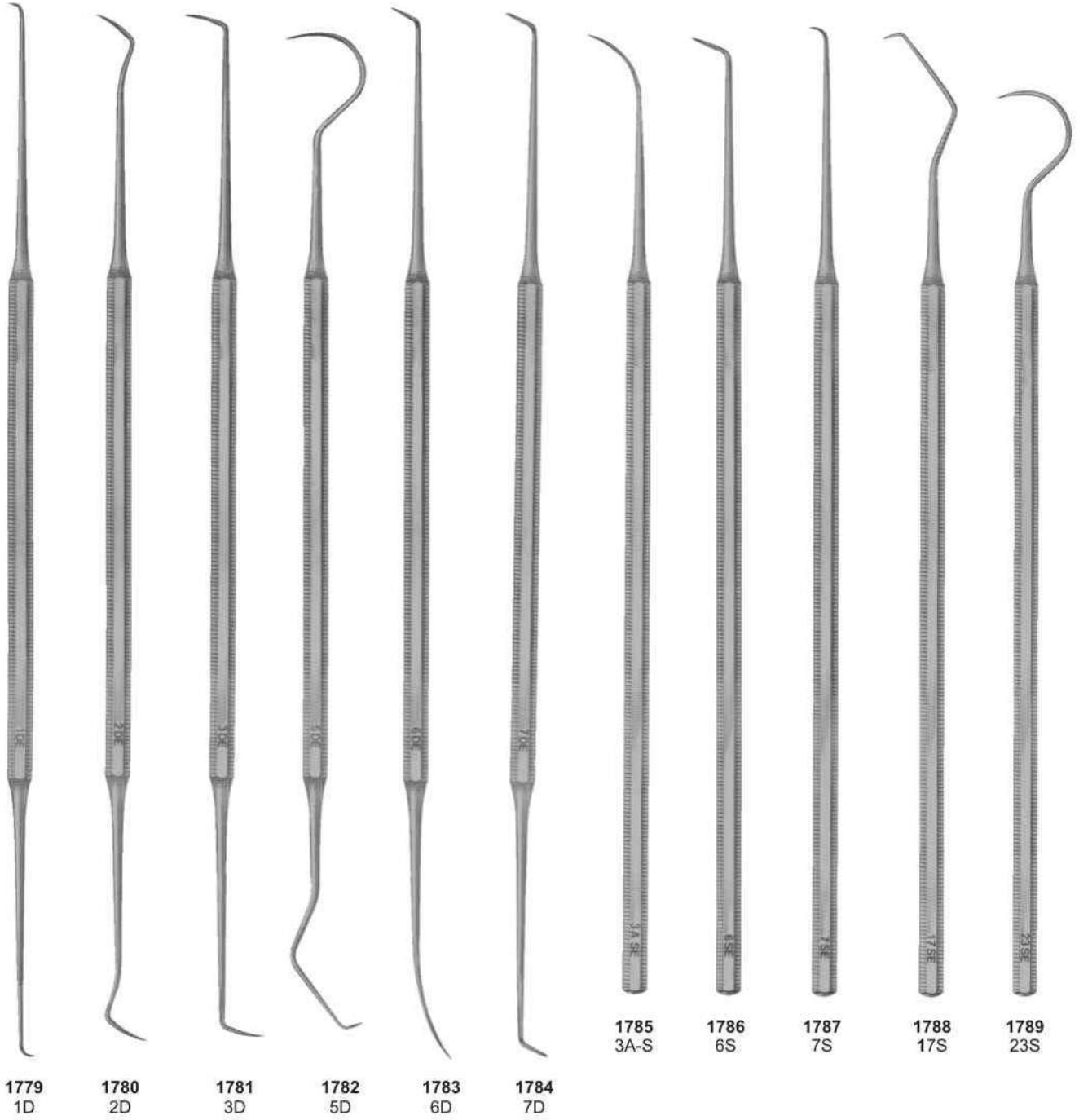

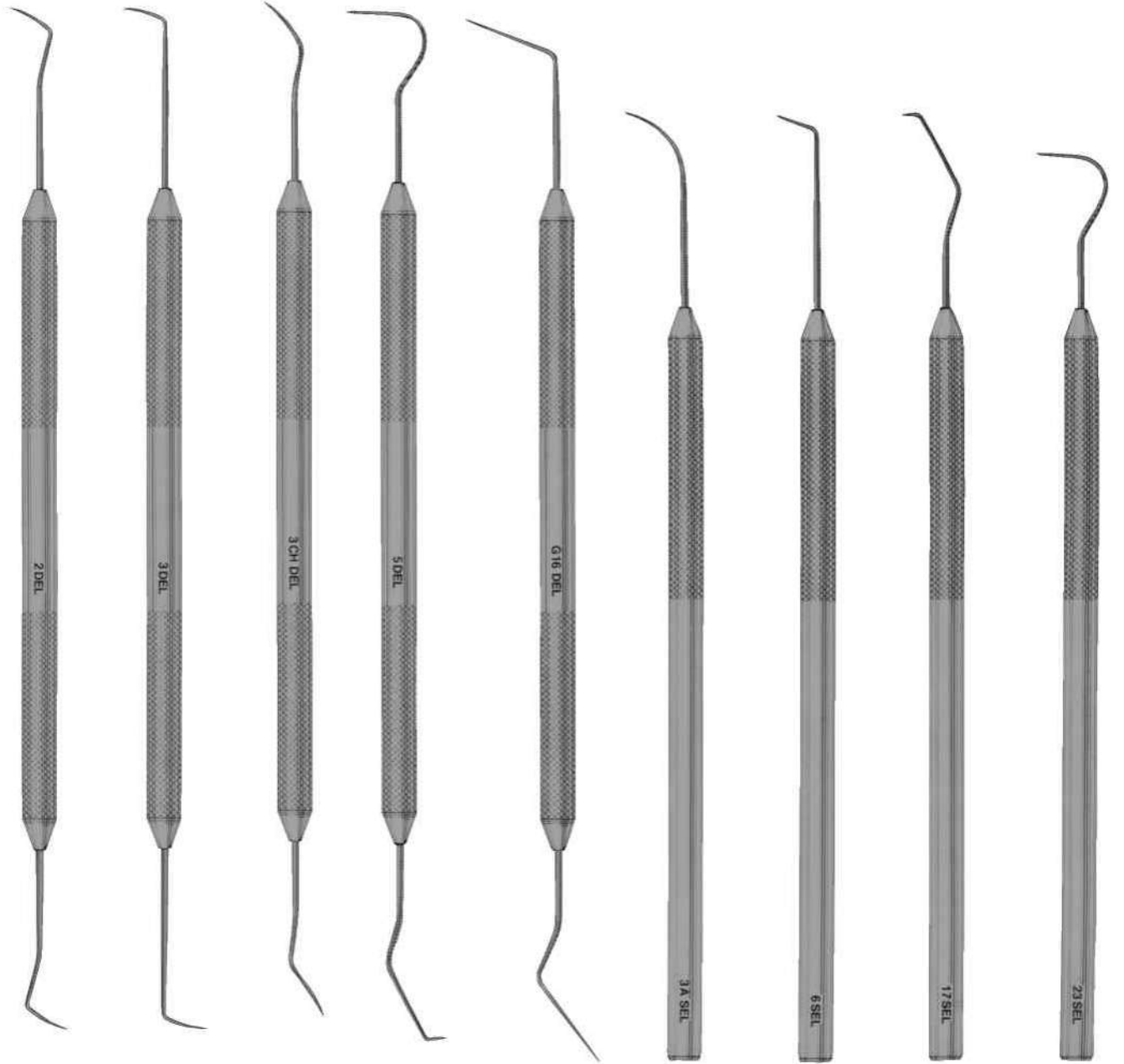

1790
No. 2D-L

1791
No. 3D-L

1792
No. 3CHD-L

1793
No. 5D-L

1794
No. G16D-L

1795
No. 3AS-L

1796
No. 6S-L

1797
No. 17S-L

1798
No. 23S-L

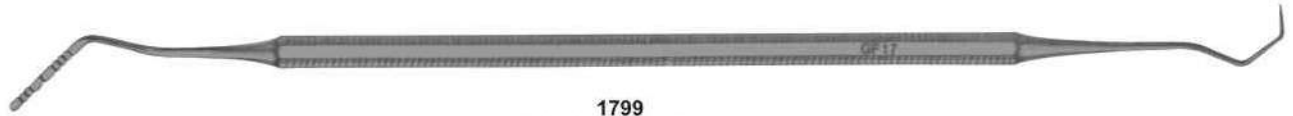

1799
Gf17 Probe/Explorer



1800
PE 1-23 Probe/Explorer

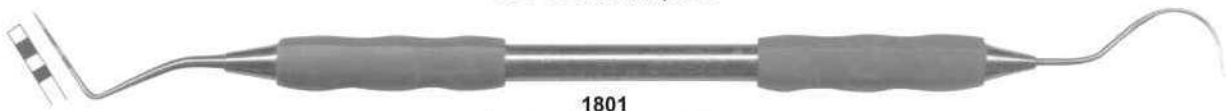

1801
Probe 0 / 23 Explorer (fine)



1802
Probe 1 / 23 Explorer



1804
Probe 4 / 23 Explorer



1803
Probe OW / 23 Explorer



1805
Ball Tip Probe WHO / 23 Explorer

PROBES



1806
Gf18 Probe



1807
"C" Probe



1808
X2 Probe



1809
1-2 (Probe 2 end is flat)



1810
1 UNC 15



1811
4 SE

CORD PACKERS



1812

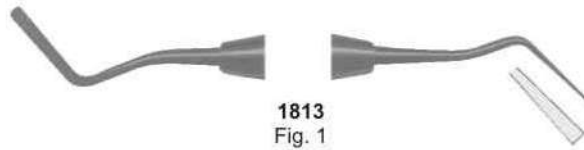

1813
Fig. 1



1814
Fig. 2



1815
BLOOMFIELD
Fig. 2 (off angle)



1816
Fig. 1



1817
CSI-1 (slightly serrated on ends)



HATCHETS



1818
1mm (10-7-14)



1819
1.3mm (13-10-16)



1820
1.5mm (15-8-14)

HOES

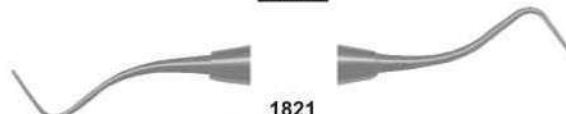

1821
1mm (10-8-16)



1822
UWH 18-19



1823
UWH 16-18



1824
UWH 20-21



1825
P.K.Thomas 1



1826
P.K.Thomas 2



1827
P.K.Thomas 3



1828
P.K.Thomas 4



1829
P.K.Thomas 5



7001
Gracey Currettes Set of 7 Pcs, Silicon Handle - Reuseable



1830
BEHRMAN (Fig. 1)



1831
BLACK (Fig. 1-2)



1832
MORQUETTE (Fig. 0/1)



1833
Black Action 11/12 Plugger



1834
Hollenback No.1 Plugger



1835
Hollenback No. 2 Plugger

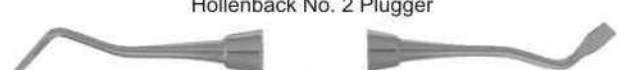

1836
Hollenback No. 3 Plugger



1837
Blacks 0-1 (1mm-1.5mm)



1838
Blacks 1-2 (1.5mm-2.5mm)

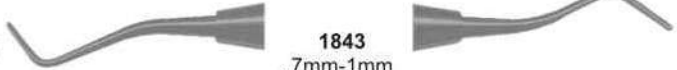

1843
.7mm-1mm



1839
Bodkin 1 (.7mm-1mm)



1844
1mm-1.5mm

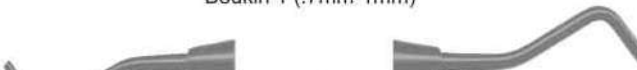

1840
Bodkin 2 (1.5mm-2mm)

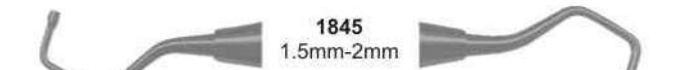

1845
1.5mm-2mm

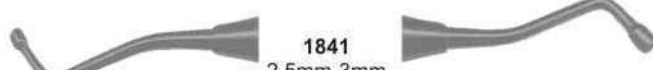

1841
2.5mm-3mm



1846
Oregon (Fig. 3)



1842
Oregon 2



1847
Oregon (Fig. 4)



1848
UP 12



1849
Applicator 1-2



1850
Birtles Applicator Spatula



1851
Birtles Applicator Spatula K

Placement Instruments

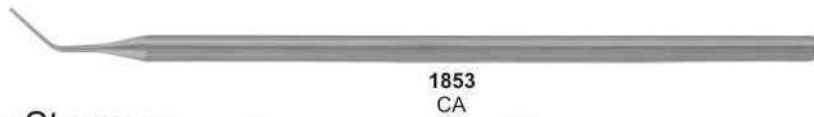

Stopping Stoppers



Pluggers



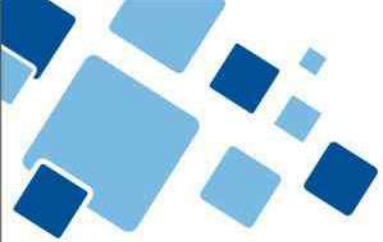

الإكسير سرجكل
ELIXIR SURGICAL

- ⟨🦷⟩ Burnishers
- ⟨🦷⟩ Carvers
- ⟨🦷⟩ Chisels
- ⟨🦷⟩ Composite Placements
- ⟨🦷⟩ Filling Instruments
- ⟨🦷⟩ Curettes
- ⟨🦷⟩ Disposable Instruments

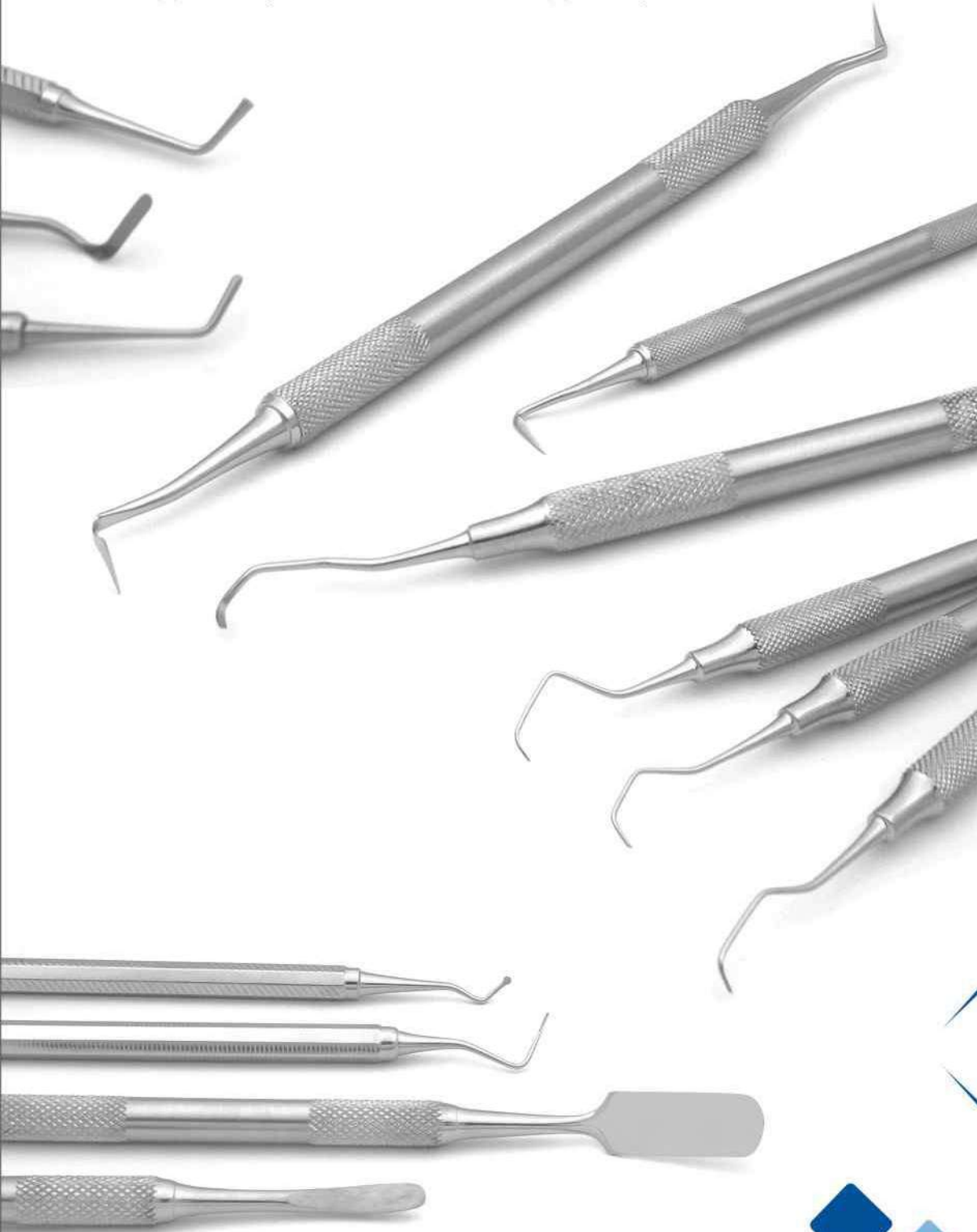

03

SECTION



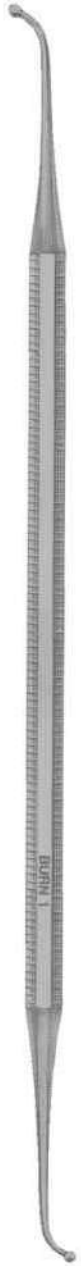

1864
Fig. 1



1865
Fig. 28/29



1866
Fig. 34



1867
Fig. 27/29



1868
Fig. 21B



1869
ACORN
Fig. 21



1872
Fig. 2-34



1874
Fig. 26-28



1876
Fig. 26-30



1878
PKT 1



1880
PKT 2



1883
PKT 3



1885
PKT 3P

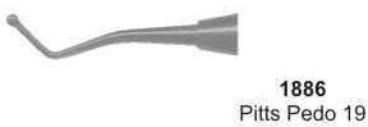

1887
PKT 4



1889
PKT 5

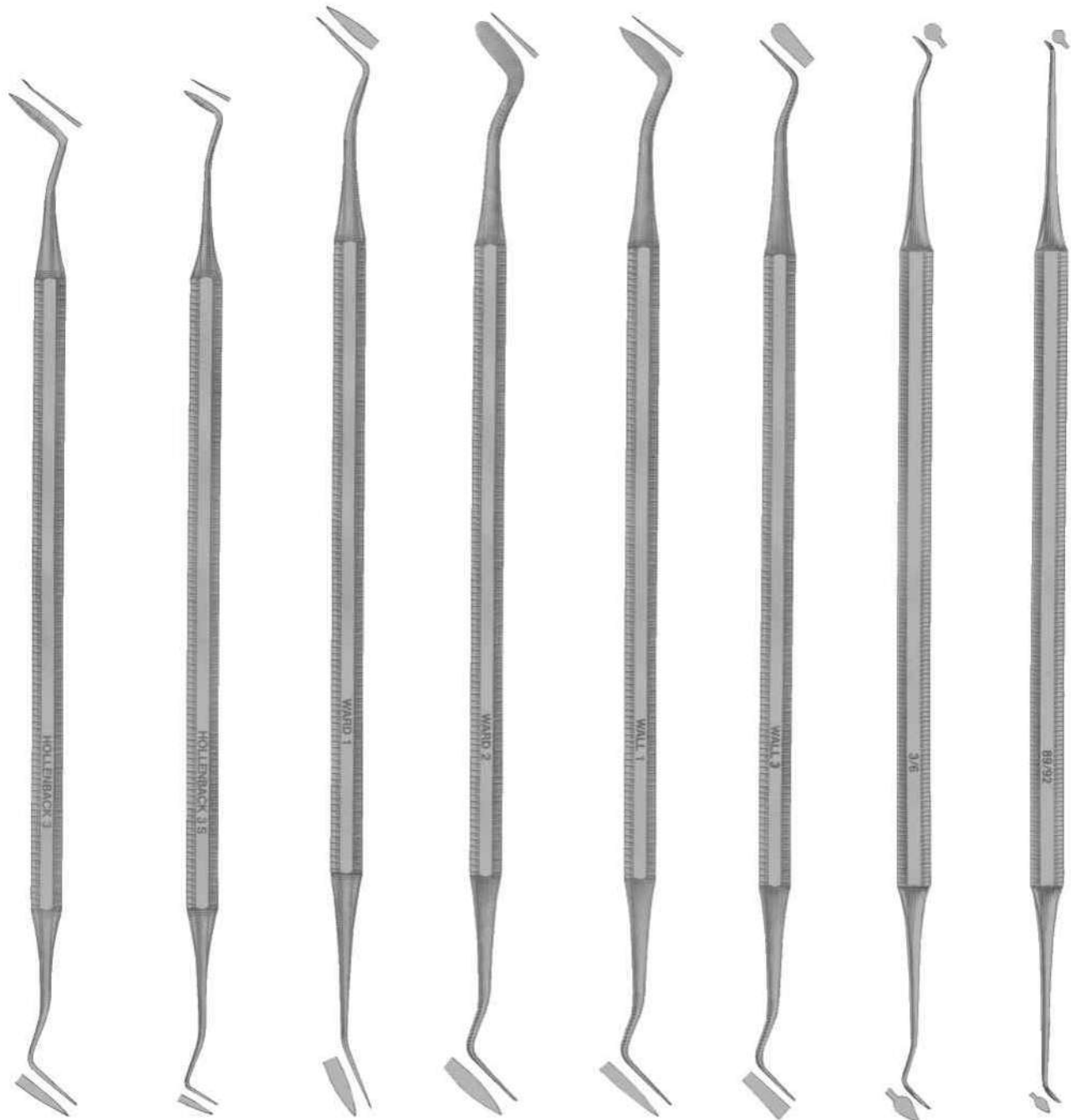

1890
HOLLENBACK
Fig. 3

1891
HOLLENBACK
Fig. 3S

1892
WARD
Fig. 1

1893
WARD
Fig. 2

1894
WALL
Fig. 1

1895
WALL
Fig. 3

1896
Fig. 3/6
Cleoid/Discoïd

1897
Fig. 89/92
Cleoid/Discoïd



1898
1.5mm Cleoid Discoid (Shown with GTX Finish)



1899
2mm Cleoid Discoid



1900
GOLLOBIN
Fig. 1



1901
3mm Cleoid Discoid



1902
HOLLENBACK
Fig. 1/2



1903
FRAHM
Fig. 2-3 (off-angle)

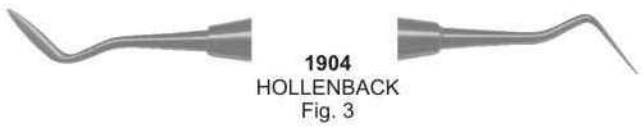

1904
HOLLENBACK
Fig. 3



1905
Interproximal 1

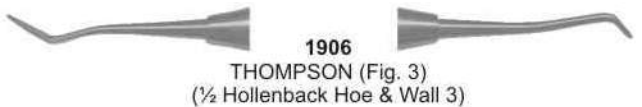

1906
THOMPSON (Fig. 3)
(½ Hollenback Hoe & Wall 3)



1907
Interproximal 1

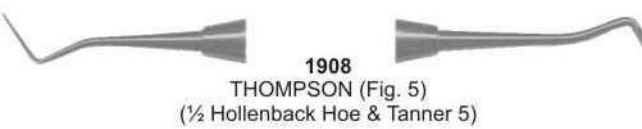

1908
THOMPSON (Fig. 5)
(½ Hollenback Hoe & Tanner 5)



1909
Baum Interproximal



1910
THOMPSON (Fig. 8)
(3mm Cleoid & Wall 3)



1911
Sho A Carver



1912
THOMPSON (Fig. 9)
(Hollenback 3 & Wall 3)



1913
Thompson 2



1914
WARD
Fig. 2



1915
Composite Interproximal



1916
TANNER
Fig. 5



1917
TANNER
Fig. 6



1920
University of Minnesota
Fig. 1



1921
University of Minnesota
Fig. 2



1918
THARP
Fig. 1



1919
THOMPSON
Fig. 1



1922
UPR
Fig. 1



1923
WALL
Fig. 3

Contour Carbide Carvers - Finishing



1924
Contour Carbide (Fig. 1-2)



1925
Cleoid Discoid



1926
Contour Carbide (Fig. 10-11)

Chisels



1927
1.5mm Bin-Angle (15-8-8)



1928
1.5mm Straight (15)



1930
1.5mm Wedelstaedt (15-15-3)



1929
1mm Wedelstaedt (10-15-3)



1931
2mm Wedelstaedt (20-15-3)

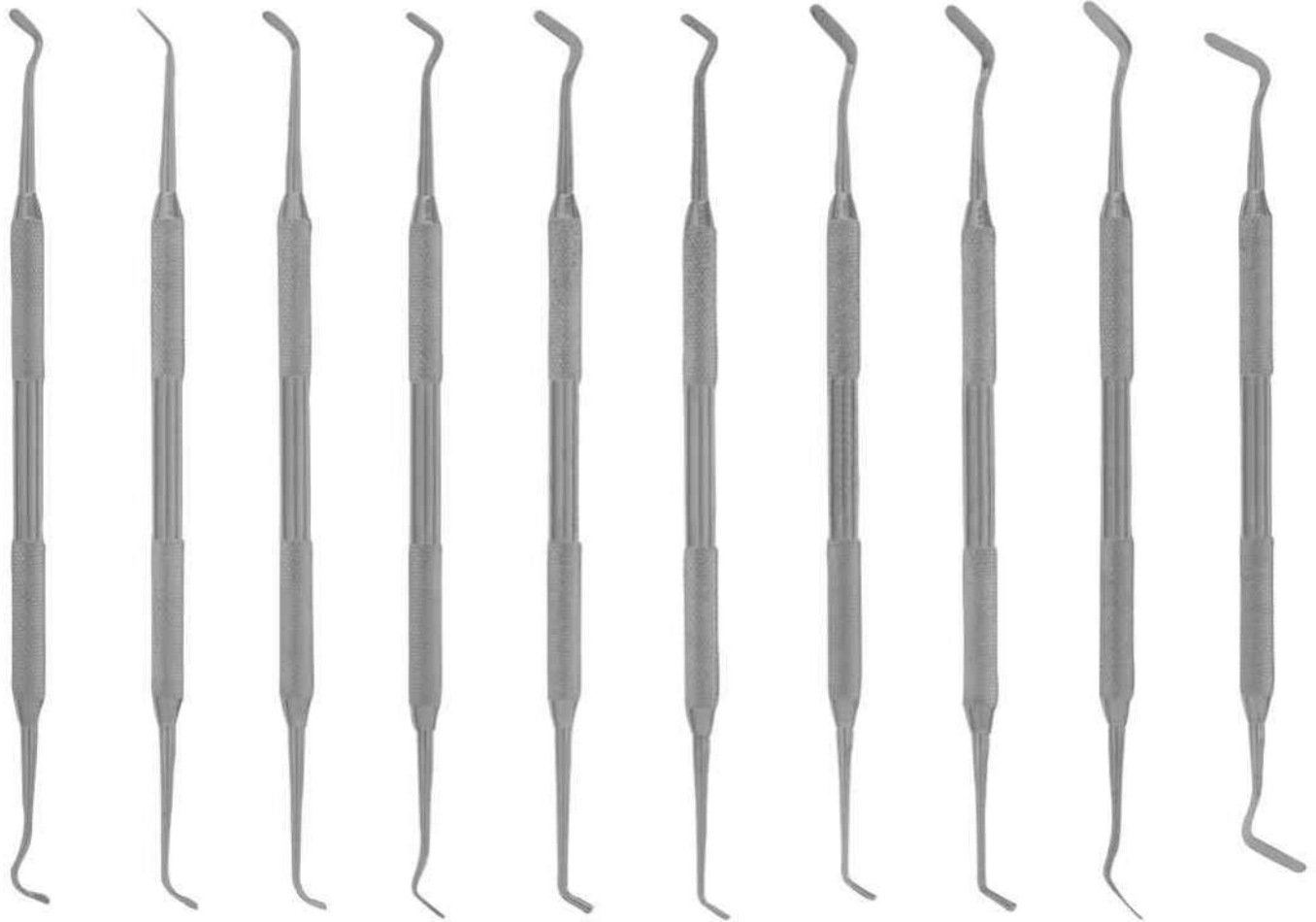

1932
F-Type 1

1933
F-Type 2

1934
F-Type 3

1935
F-Type 4

1936
F-Type 5

1937
F-Type 6

1938
G-Type 1

1939
G-Type 2

1940
G-Type 3

1941
G-Type 4

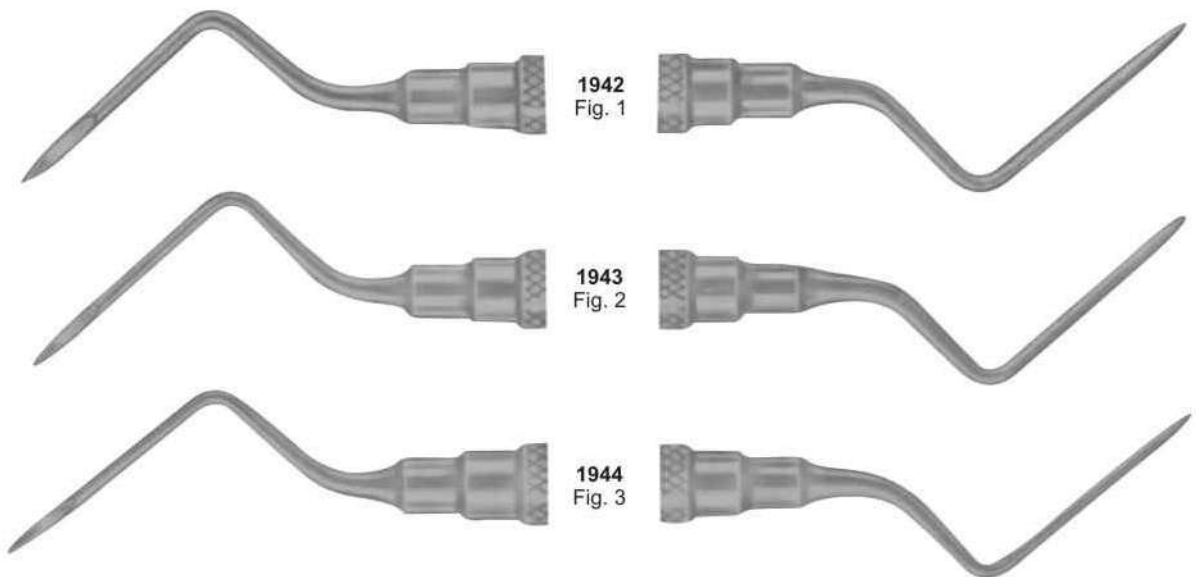

1942
Fig. 1

1943
Fig. 2

1944
Fig. 3



1945
Fig. 2



1946
Fig. 3 (off-set blade)



1947
Fig. 4



1948
Fig. 5

1954
Fig.12



1949
Fig. 6



1950
Fig.7



1951
Fig.8

1955
Fig.15



1952
Fig.9



1953
Fig.11



1956
JORDAN
Fig. 2

1957
FREEDMAN
Fig. 1



1958
FREEDMAN
Fig. 2



1959
FREEDMAN
Fig. 3

1960
Dr. Dan



1961
SIMON
Fig. 2

K - Type

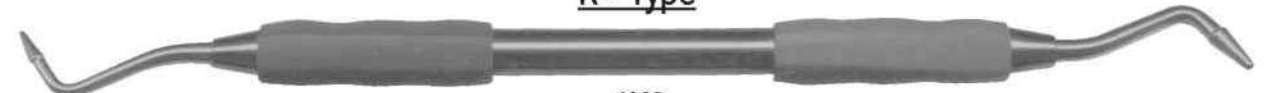

1962
K-Type 1



1963
K-Type 2



1965
K-Type 4



1964
K-Type 3



1966
K-Type 5



1967
K-Type 6 Carbide

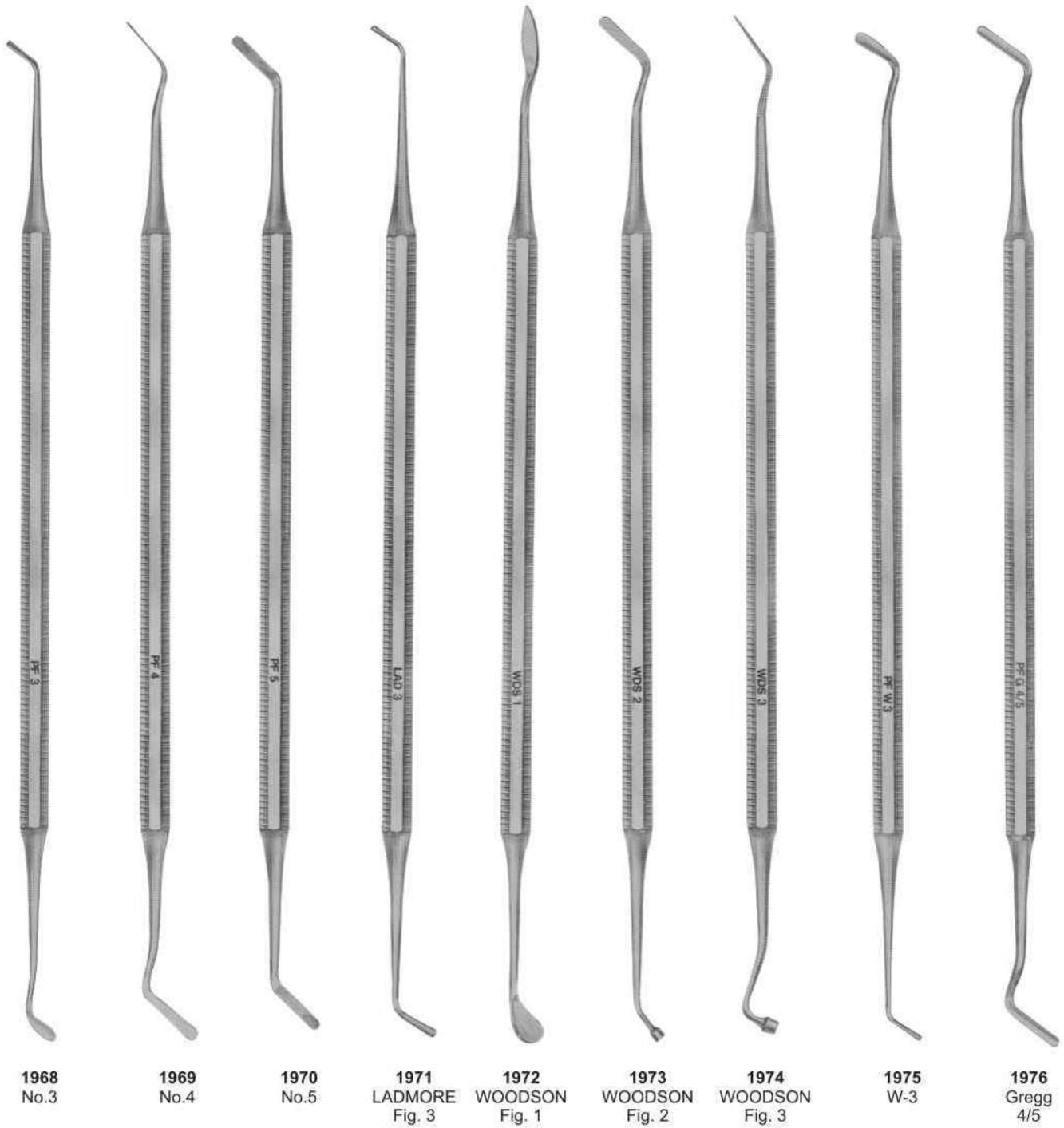

1968
No.3

1969
No.4

1970
No.5

1971
LADMORE
Fig. 3

1972
WOODSON
Fig. 1

1973
WOODSON
Fig. 2

1974
WOODSON
Fig. 3

1975
W-3

1976
Gregg
4/5



1977
Fig. 5-7



1978
Fig.1



1979
Fig. 3



1983
GLICK
Fig.1



1980
Fig. 4



1984
P8



1981
Fig. 5-7



1985
WOODSON
Fig. 1



1982
Fig. 8A



1986
WOODSON
Fig. 2



1987
WOODSON
Fig. 3





1988
GRACEY
GC 1-2



1989
GRACEY
GC 3-4



1990
GRACEY
GC 5-6



1991
GRACEY
GC 7-8



1992
GRACEY
GC 9-10



1993
GRACEY
GC 11-12



1994
GRACEY
GC 13-14

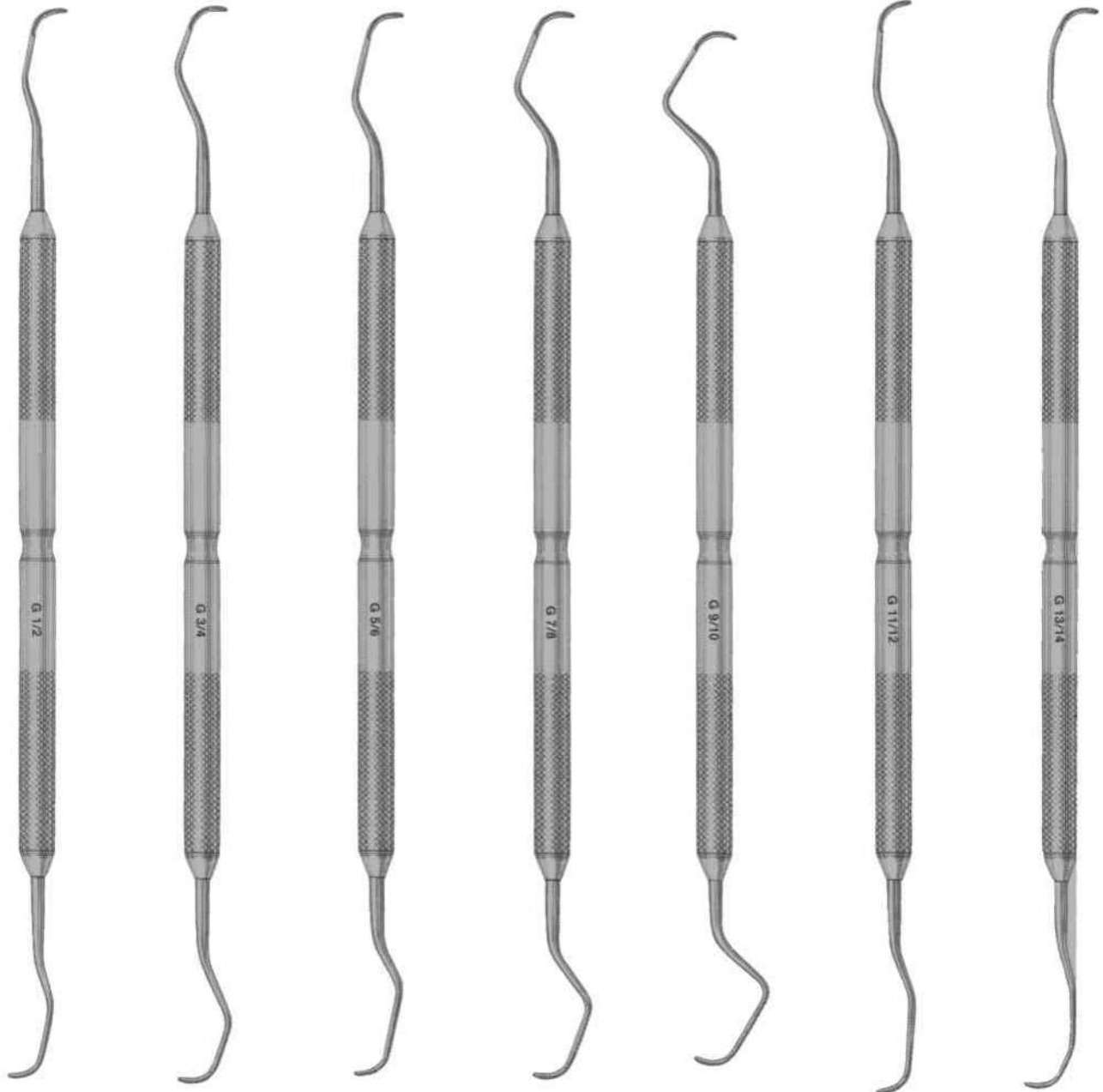

1995
G1-2

1996
G3-4

1997
G5-6

1998
G7-8

1999
G9-10

2000
G11-12

2001
G13-14

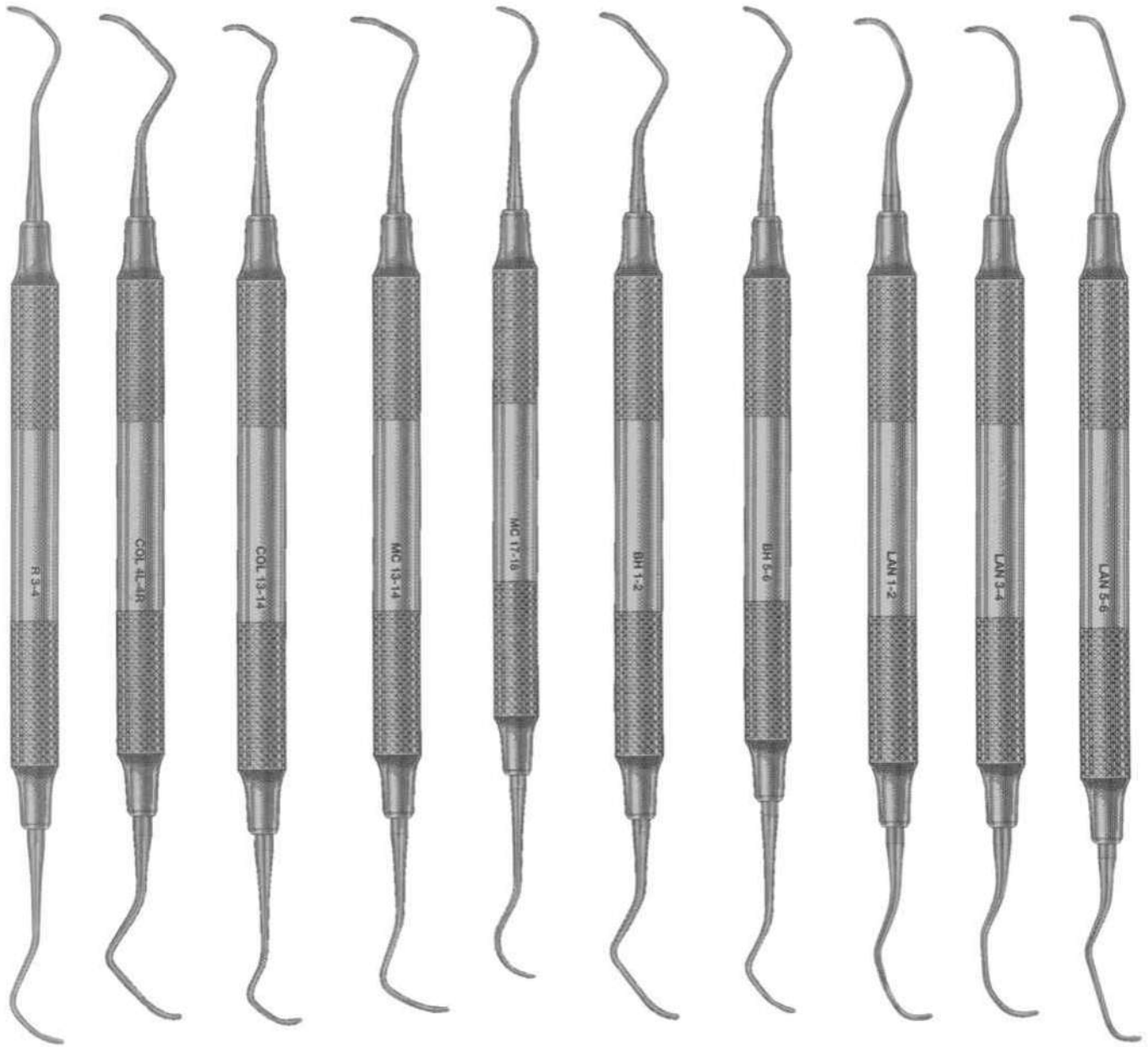

2002
RULE
3-4

2003
COLUMBIA
4R-4L

2004
COLUMBIA
13-14

2005
MCCALLS
13-14

2006
MCCALLS
17-18

2007
BARNHART
1-2

2008
BARNHART
5-6

2009
LANGER
1-2

2010
LANGER
3-4

2011
LANGER
5-6

COLUMBIA CURETTES



2012
4L-4R

2013
13-14

2014
2L-2R

MCCALLS CURETTES



2015
13-14

2016
13S-14S

2017
17-18

2018
17S-18S

GOLDMAN FOX



2019
GF1 Universal Scaler



2020
GF2 Curette



2021
GF3 Curette



2022
GF4 Curette



2023
GF5 Hoe



2024
GF6 Hoe

GOLDMAN FOX



2025
GF 7 Knife



2026
GF 8 Spear Knife



2027
GF 9 Knife Scaler



2028
GF 11 Spear Knife



2029
GF 21 Sharp Spoon /
Small Scaler



2030
Kirkland 15 / 16



2031
Ordan 1 / 2



2032
Buck 3 / 4



2033
Buck 5 / 6



2034
Goldman-Fox 7



2035
Goldman-Fox 8



2036
Goldman-Fox 9



2037
Goldman-Fox 11



2038
CK 3 (Crane)

Interproximal Files

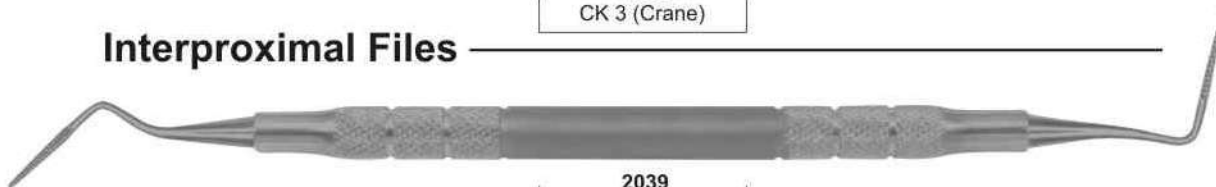

2039
Sugarman 1S-2S

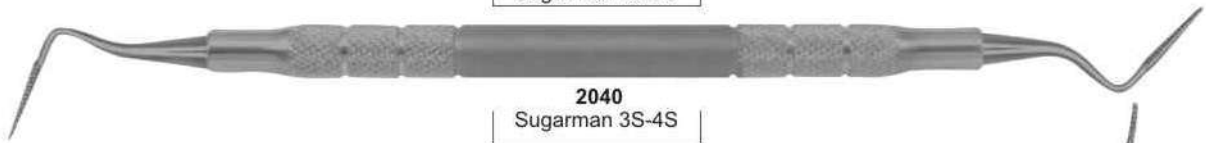

2040
Sugarman 3S-4S

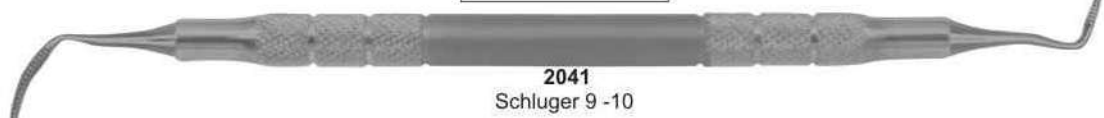

2041
Schluger 9 -10



2042
Buck 11 - 12



2043
COLUMBIA (2L-2R)



2044
MCCALL (13-14)



2045
MCCALL (17S-18S)

Root Planning Curettes



2046
Root Plane (1-2)



2047
Root Plane (5-6)



2049
Root Plane (11-12)



2048
Root Plane (7-8)



2050
Root Plane (13-14)



2051
Petite (1-2)



2052
Petite (11-12)



2053
Petite (5-6)



2054
Petite (13-14)



2055
BARNHART (1-2)



2056
BARNHART (5-6)



2065
COLUMBIA (4L-4R)



2057
GRACEY (1-2)

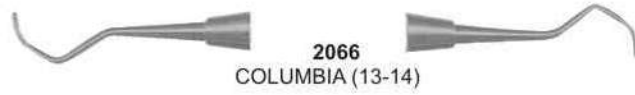

2066
COLUMBIA (13-14)

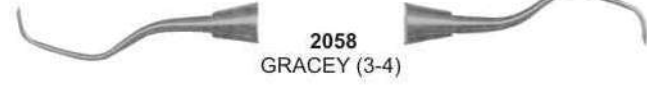

2058
GRACEY (3-4)



2067
LANGER (1-2)

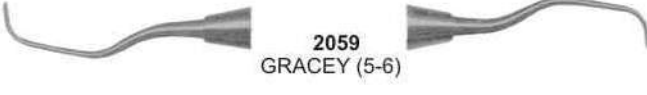

2059
GRACEY (5-6)



2068
LANGER (3-4)

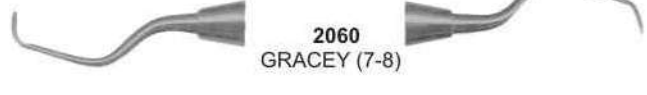

2060
GRACEY (7-8)



2069
LANGER (5-6)



2061
GRACEY (9-10)

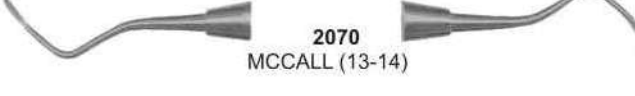

2070
MCCALL (13-14)



2062
GRACEY (11-12)

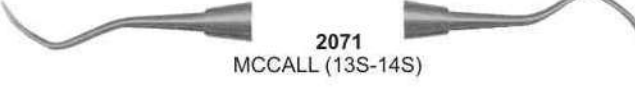

2071
MCCALL (13S-14S)

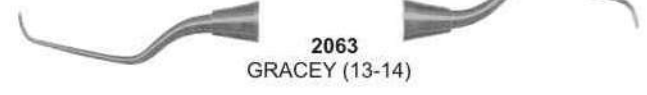

2063
GRACEY (13-14)



2072
MCCALL (17-18)

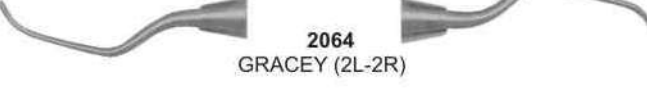

2064
GRACEY (2L-2R)

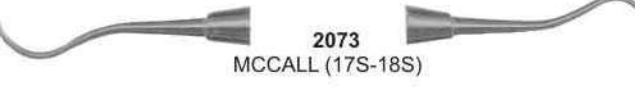

2073
MCCALL (17S-18S)



2074
RULE (3-4)



- ⟨☞⟩ Cement Instruments
- ⟨☞⟩ Bone Chisels
- ⟨☞⟩ Spatulas
- ⟨☞⟩ Bone Mallets
- ⟨☞⟩ Knives
- ⟨☞⟩ Crown Remover
- ⟨☞⟩ Bone Currettes & Files
- ⟨☞⟩ Implant Instruments



04

SECTION



Silicon Handles-Reusable

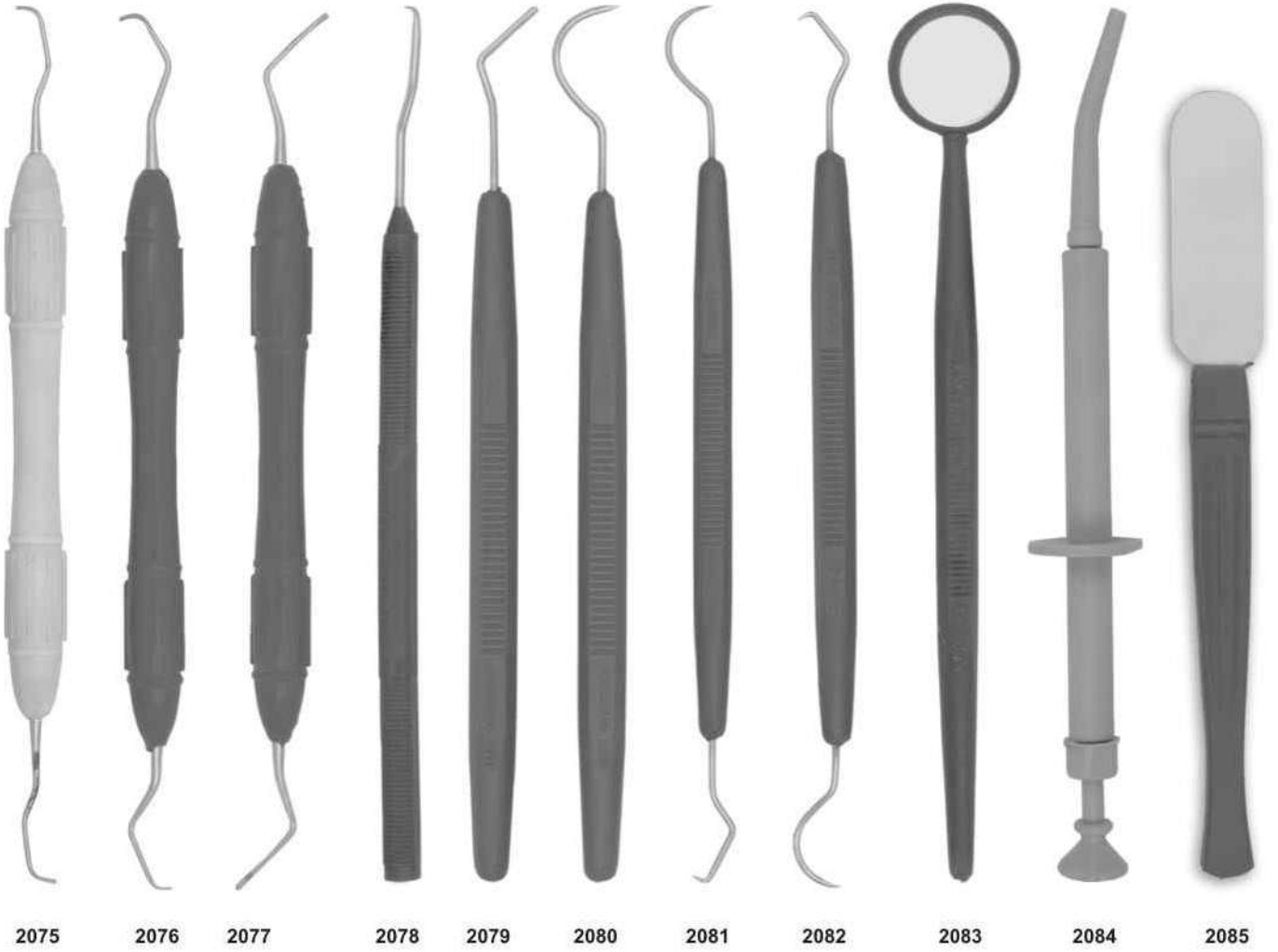

Comfort Grip
Vinyl - Covered Insulating Handles

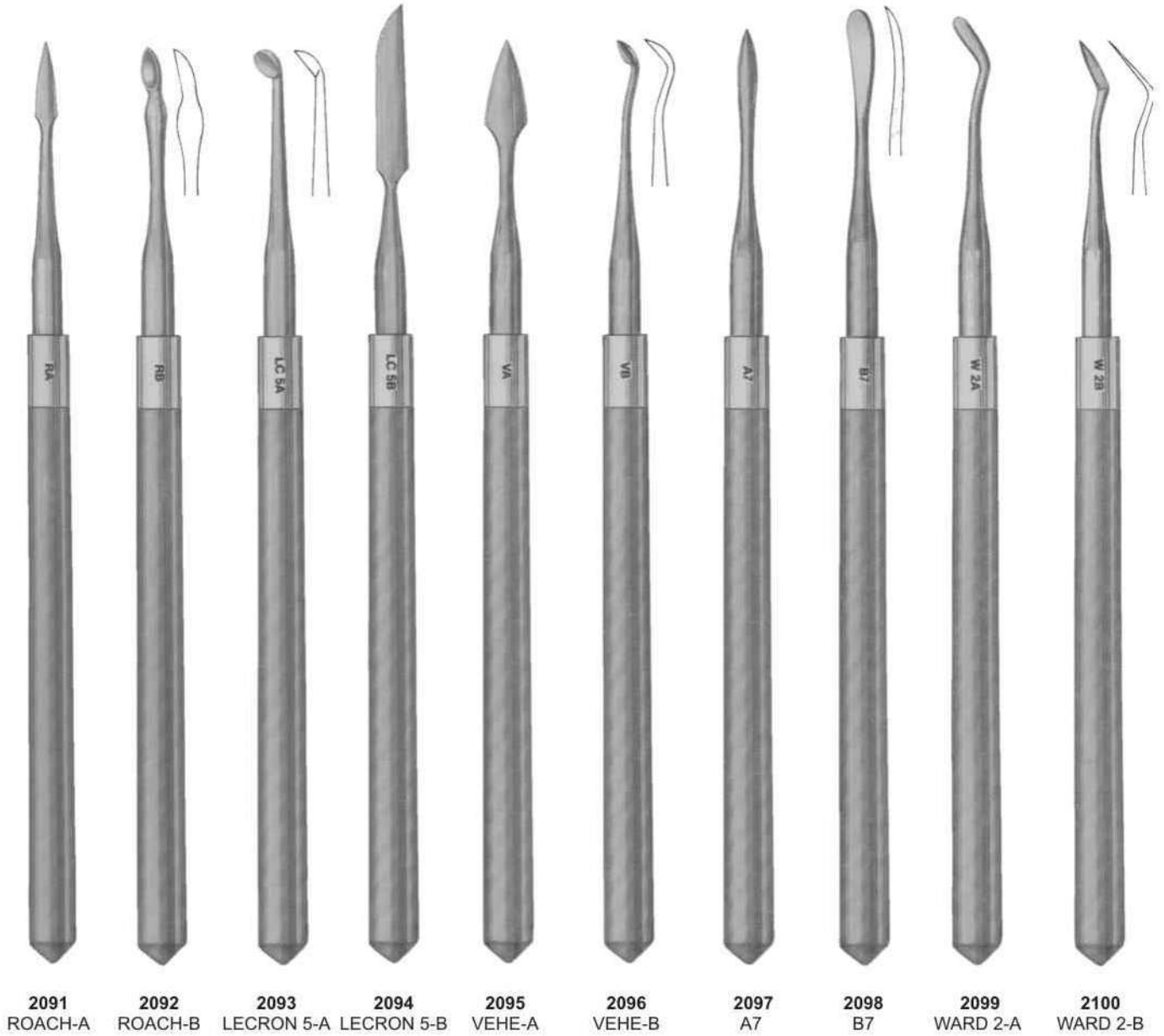

P.K. THOMAS

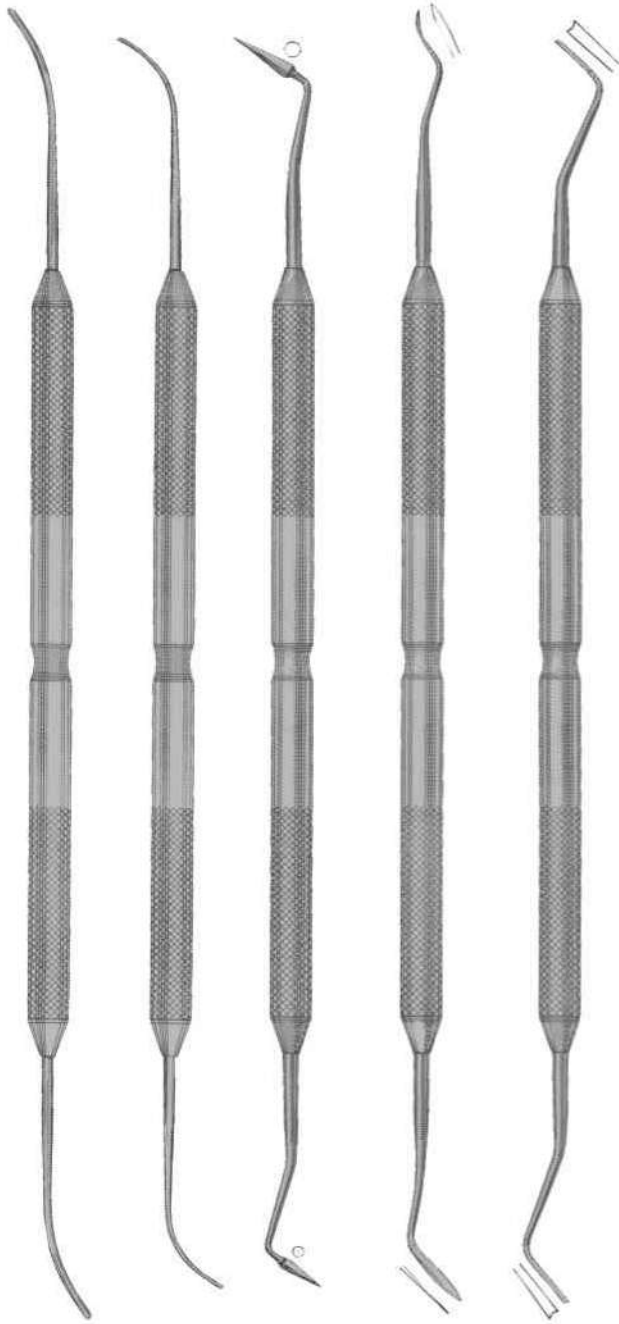

2101 PKT 1 2102 PKT 2 2103 PKT 3 2104 PKT 4 2105 PKT 5

Set of 5 instruments

WAX CARVERS

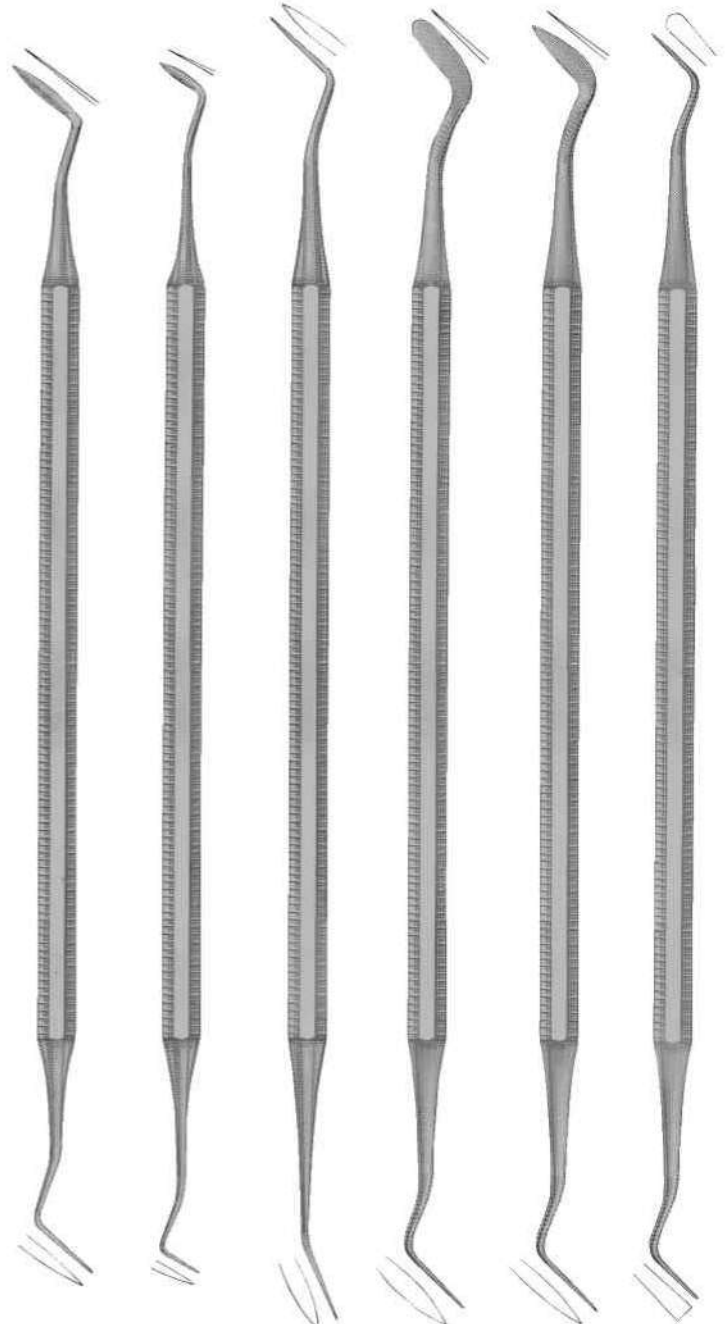

2106 Hollenback 3 2107 Hollenback 3S 2108 WARD 1 2109 WARD 2 2110 WALL 1 2111 WALL 3

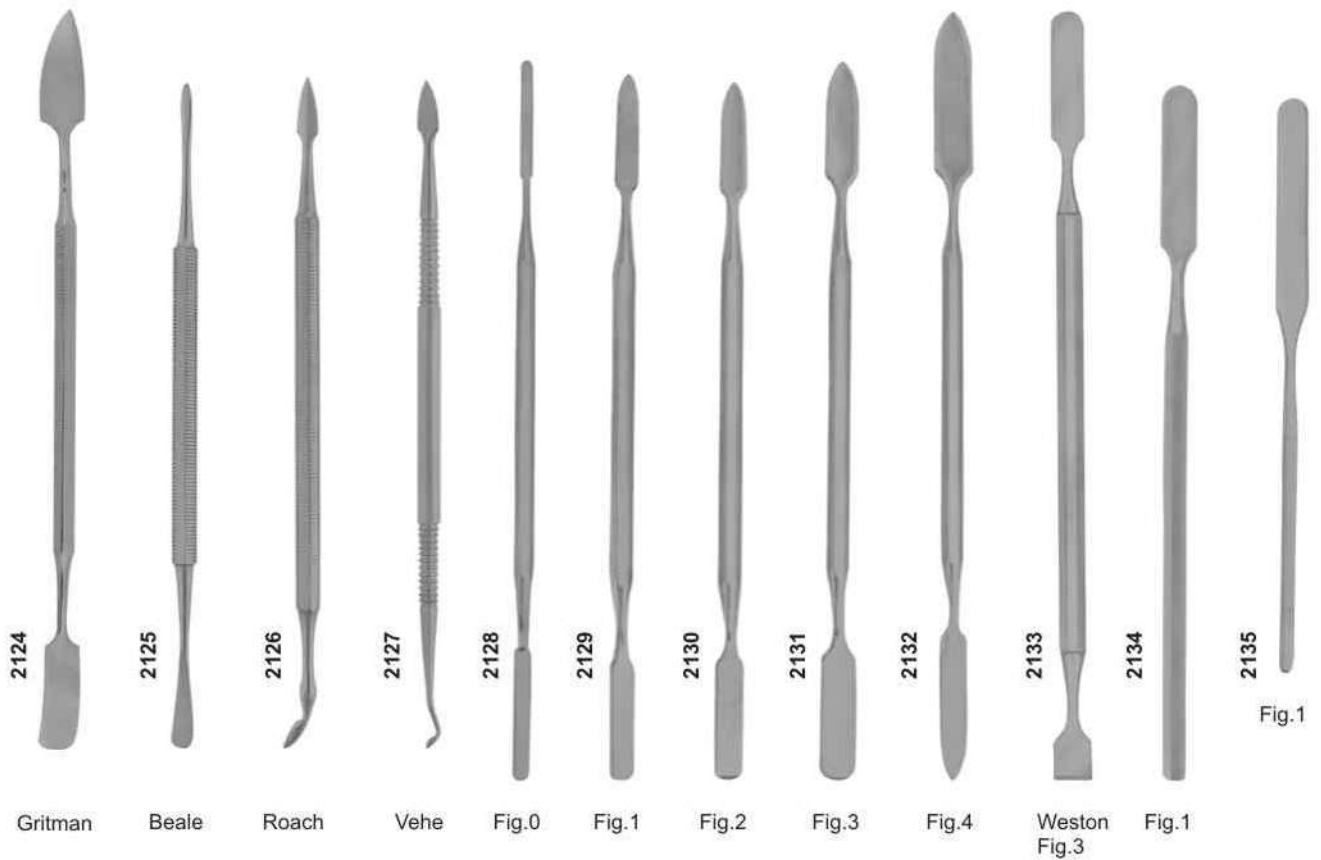
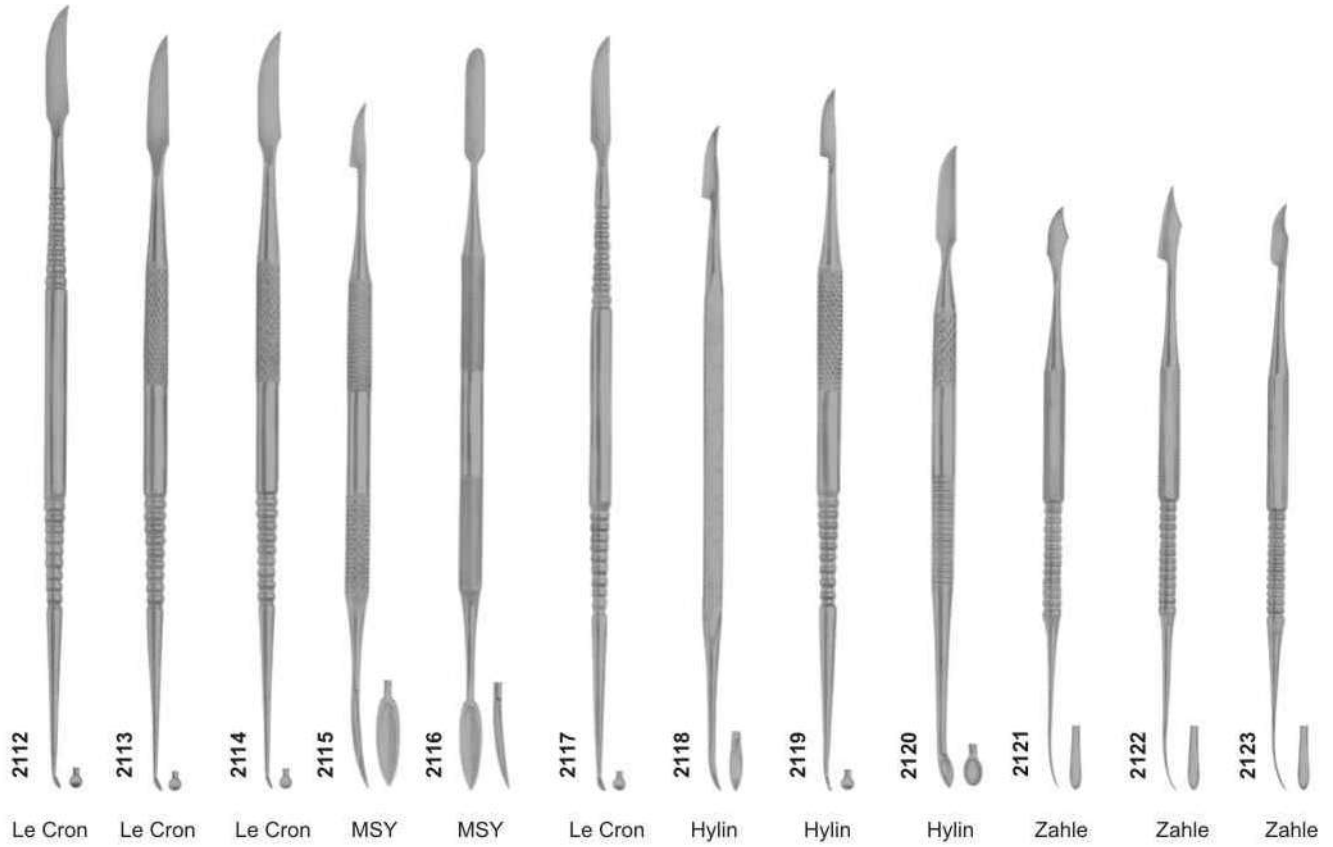

WAX & PORCELAINE CARVERS



2136
LECRON
Inlay

2137
REEVES

2138
VEHE
Wax

2139
ROACH
Wax

WAX SPATULAS

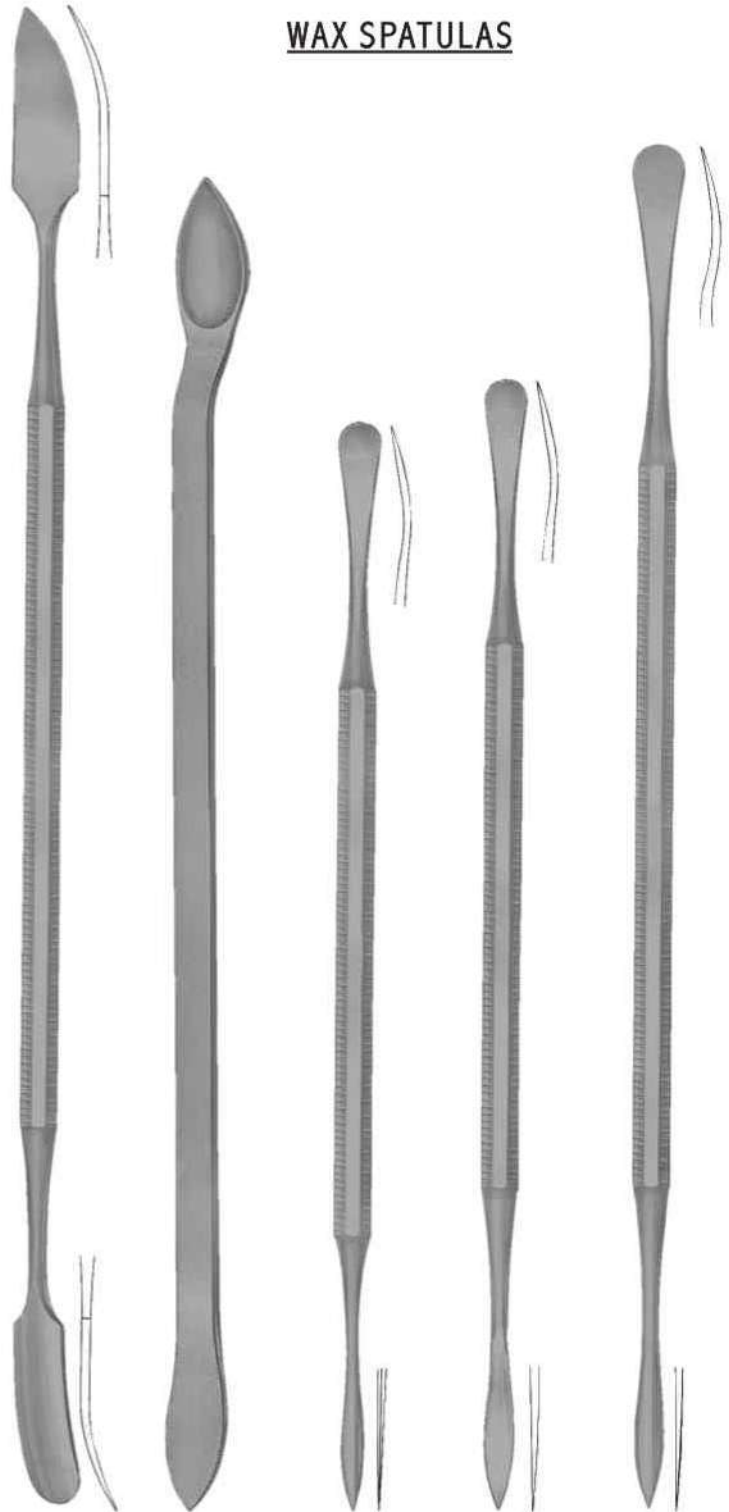

2140
W-31

2141
W-5

2142
W-7

2143
W-7A

2144
W-7G



2145
AGATHE

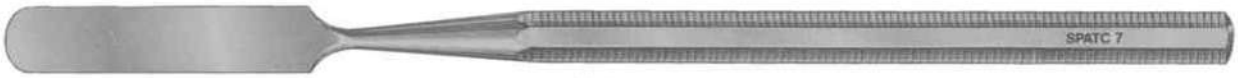

2146
C-7



2147
C-5



2148
C-313



2149
C-24A Rigid



2150
C-24 Flexible



2151
C-24 Flexible



2152
24



2153
A6



2154
7 Wax



2155
26



2156
All Metal Spatulas with High Polish
Stainless Steel Blade



2157
31

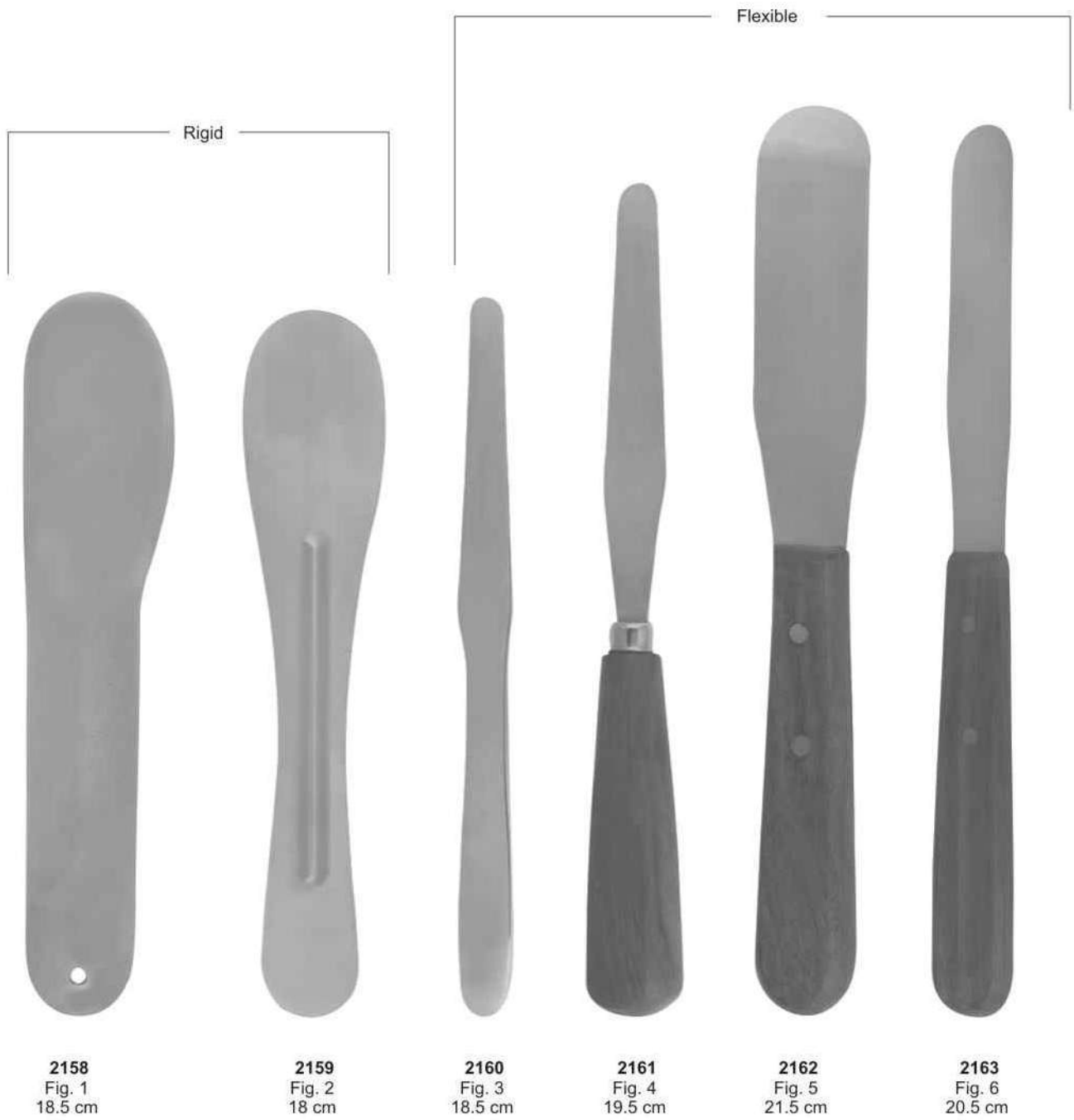



FILES

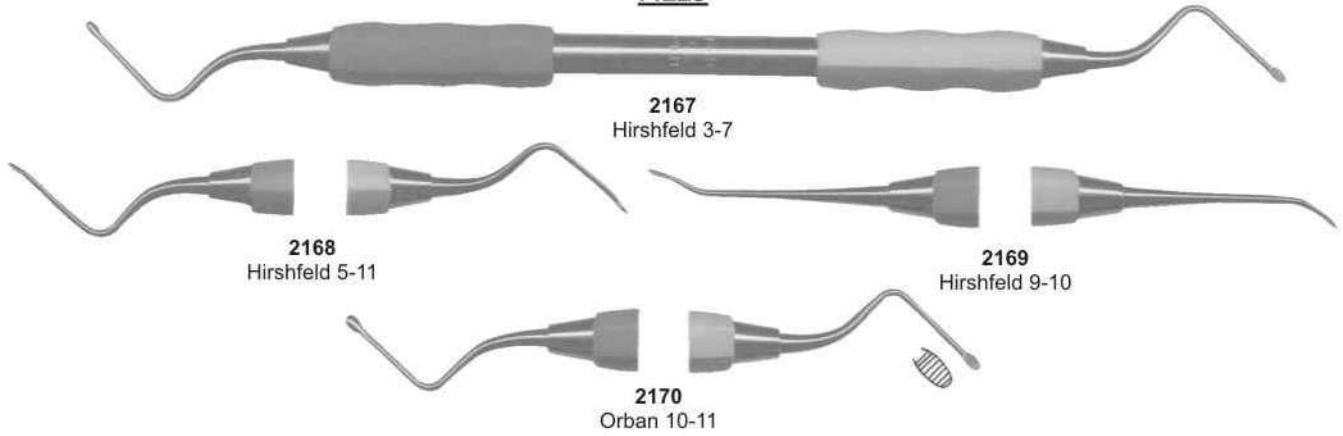

HOES

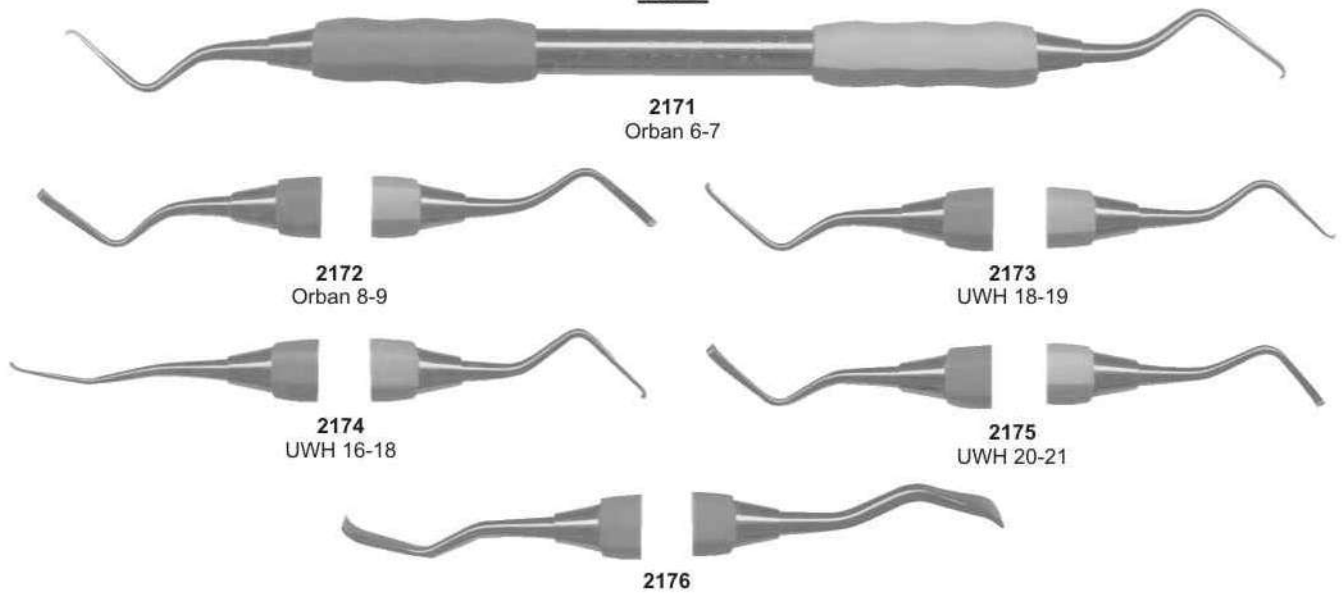

KNIVES

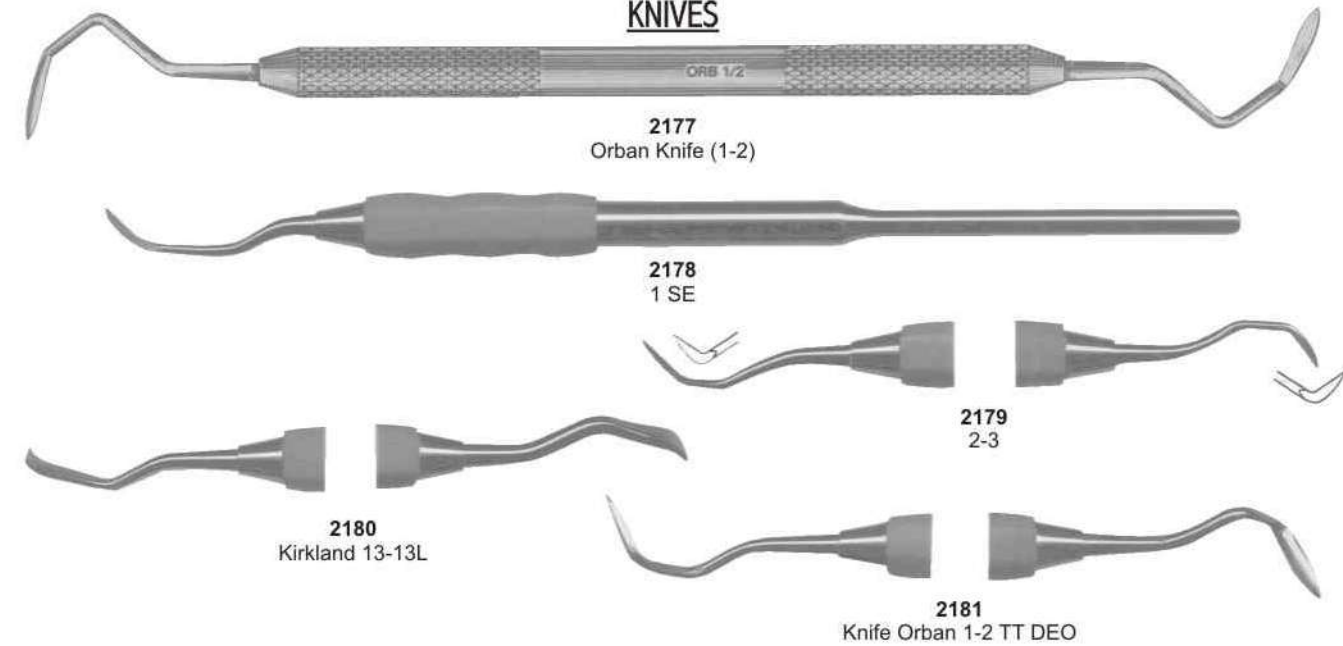



2182
Fahnenstock
Fig. 1
12,5cm

2183
Fahnenstock
Fig. 2
17cm

2184
Lessmann
Fig. 1
12,5cm

2185
Lessmann
Fig. 2
17cm

2186
Con scodellino
Fig. 1
12,5cm

2187
Con scodellino
Fig. 2
17cm

2188
Ermert

2189
Ermert



2190
18 cm
7 1/8"



2191
18 cm
7 1/8"



2192
17 cm
6 3/4"
Gritman



2193
17 cm
6 3/4"
Medicon



2194
Fig, 1
17 cm



2195
22 cm
8 3/4"



2196
22 cm
8 3/4"



2197
Gritman
Fig, 2
17 cm



2198
Fig, 3
16 cm



2199
Fig, 4
16 cm

CRANE-KAPLAN



2200
Ck1
Pocket Marker



2201
Ck2
Pocket Marker

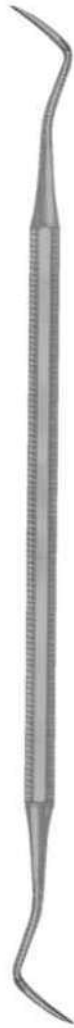

2202
Knife



2203
Dissector



2204
Scaler

OCHSENBEIN



2205
Ochsenbein
Fig. 1



2206
Ochsenbein
Fig. 2



2207
Ochsenbein
Fig. 4

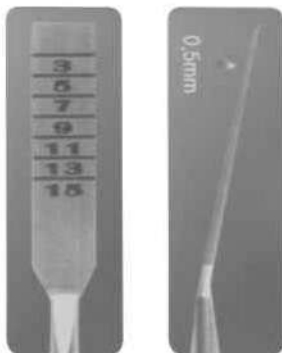

Split Chisel Set



2208
Split Chisel
6 mm Curved



2209
Split Chisel
6 mm Straight



2210
Split Chisel
4 mm Curved



2211
Split Chisel
4 mm Straight

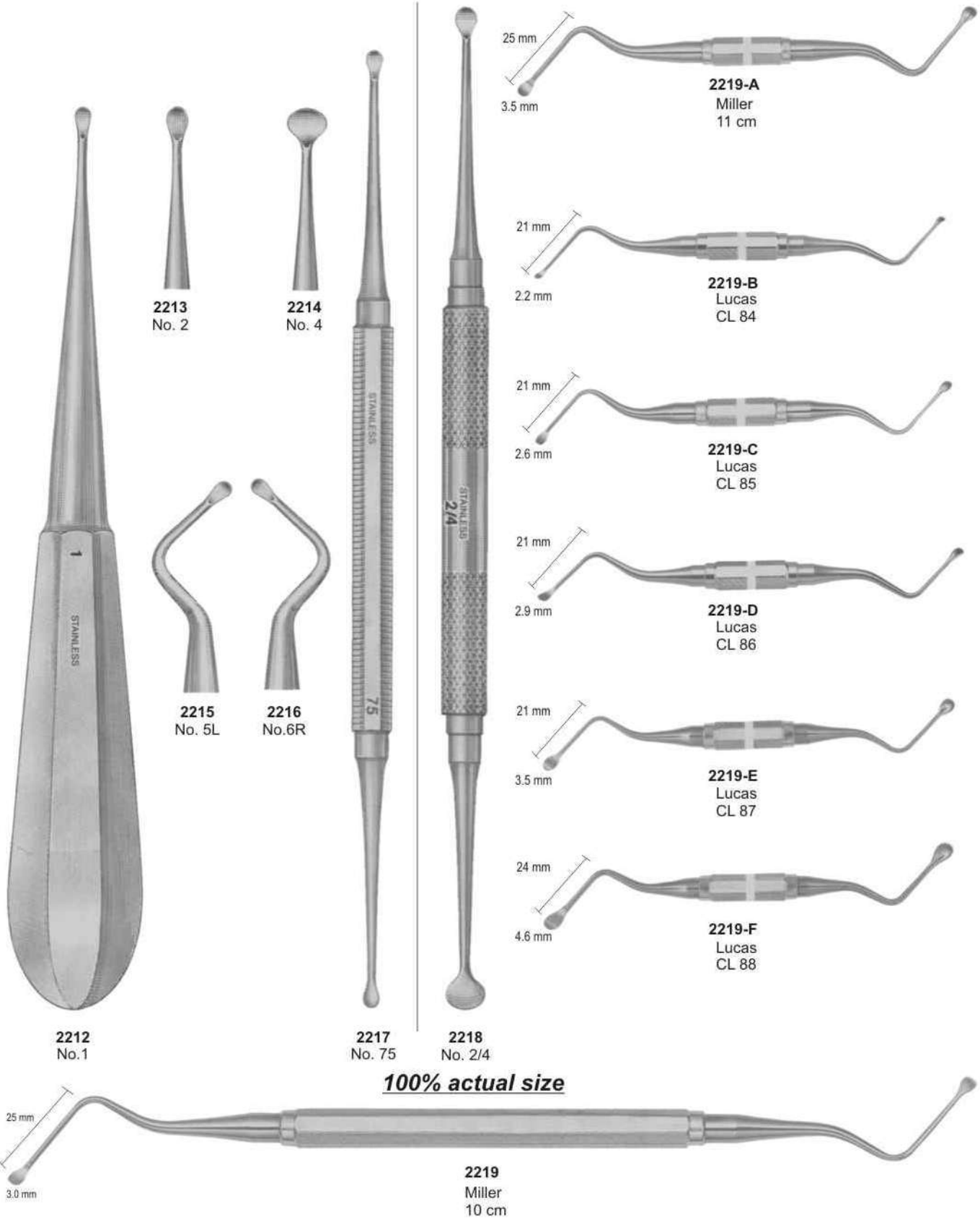

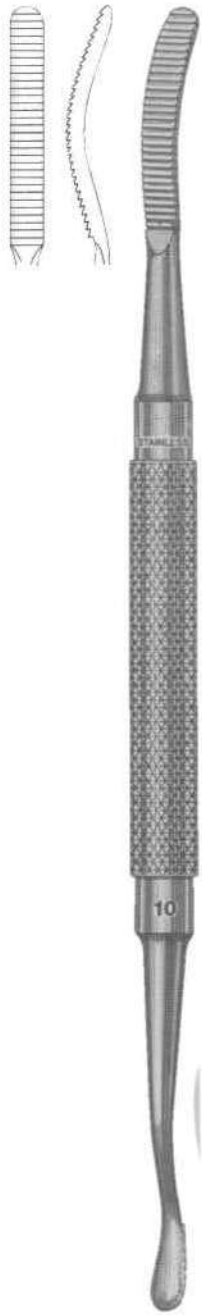

2220
No. 10

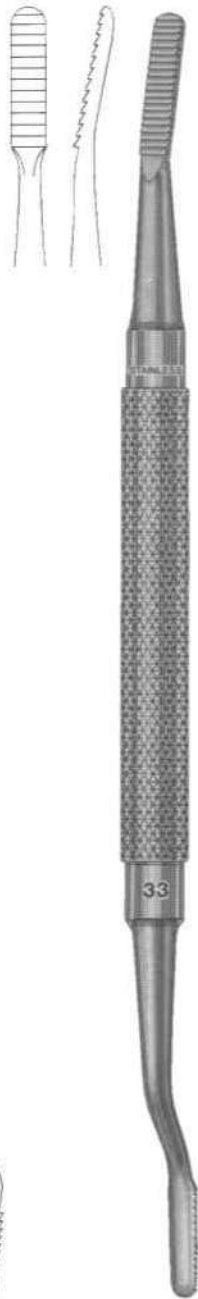

2221
No. 33

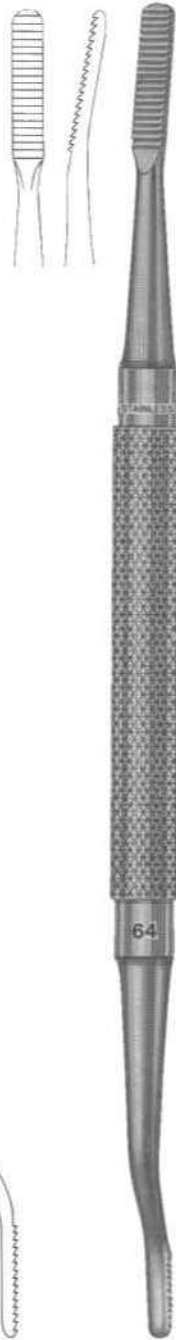

2222
MILLER
No. 64

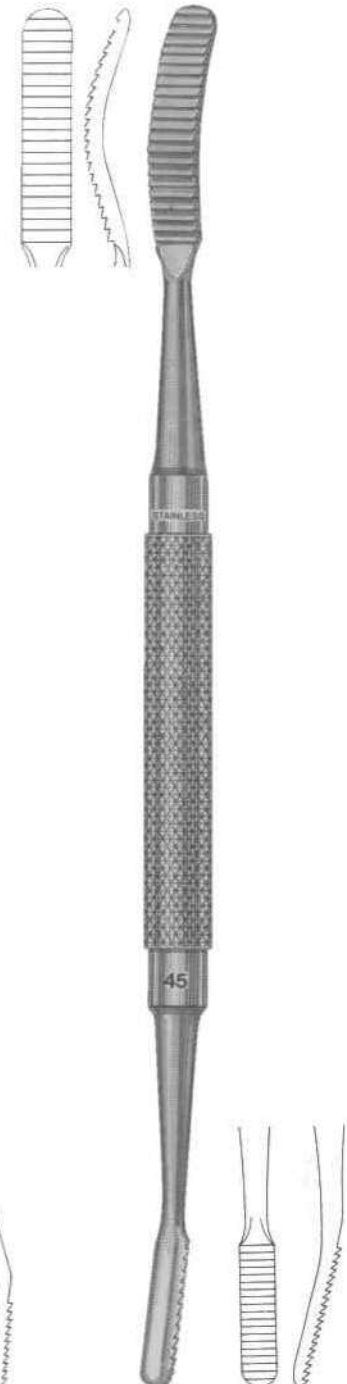

2223
MILLER
No. 45

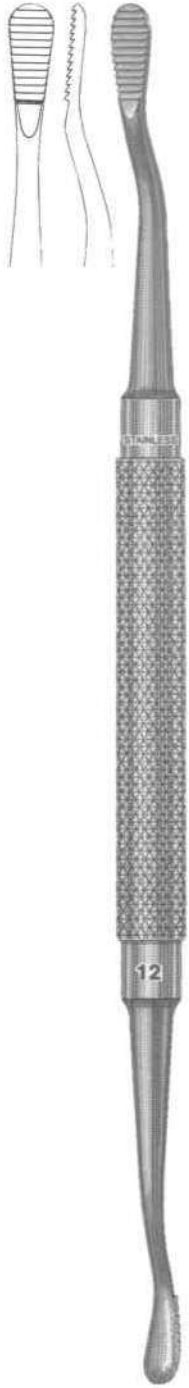
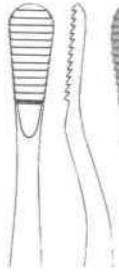

2224
HOWARD
No. 12

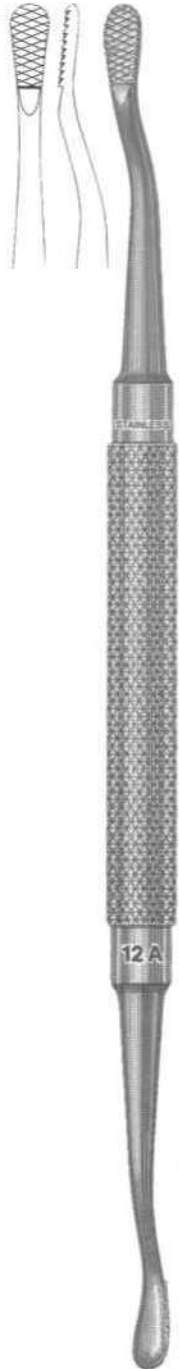

2225
HOWARD
No. 12A



2226
HOWARD
No. 12CA

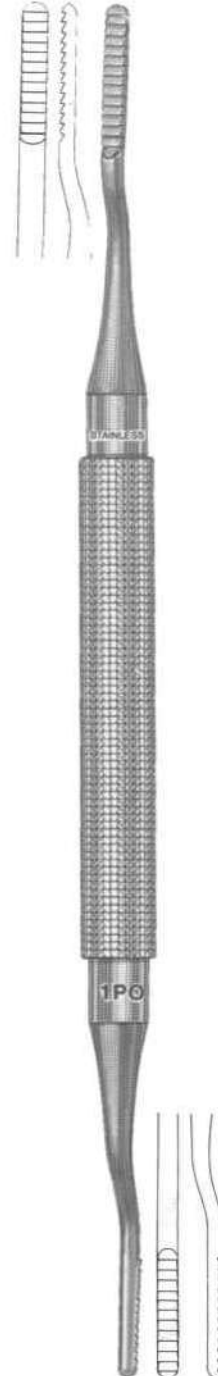
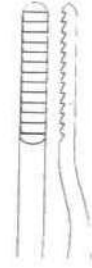

2227
POLOKOFF
No. 1

GARDNER



2228
GARDNER
No. 1

2229
GARDNER
No. 2

2230
GARDNER
No. 5

2231
GARDNER
No. 5R

WAKEFIELD



2232
WAKEFIELD
No. 1W

2233
WAKEFIELD
No. 2W

Bone Chisels and Gouges

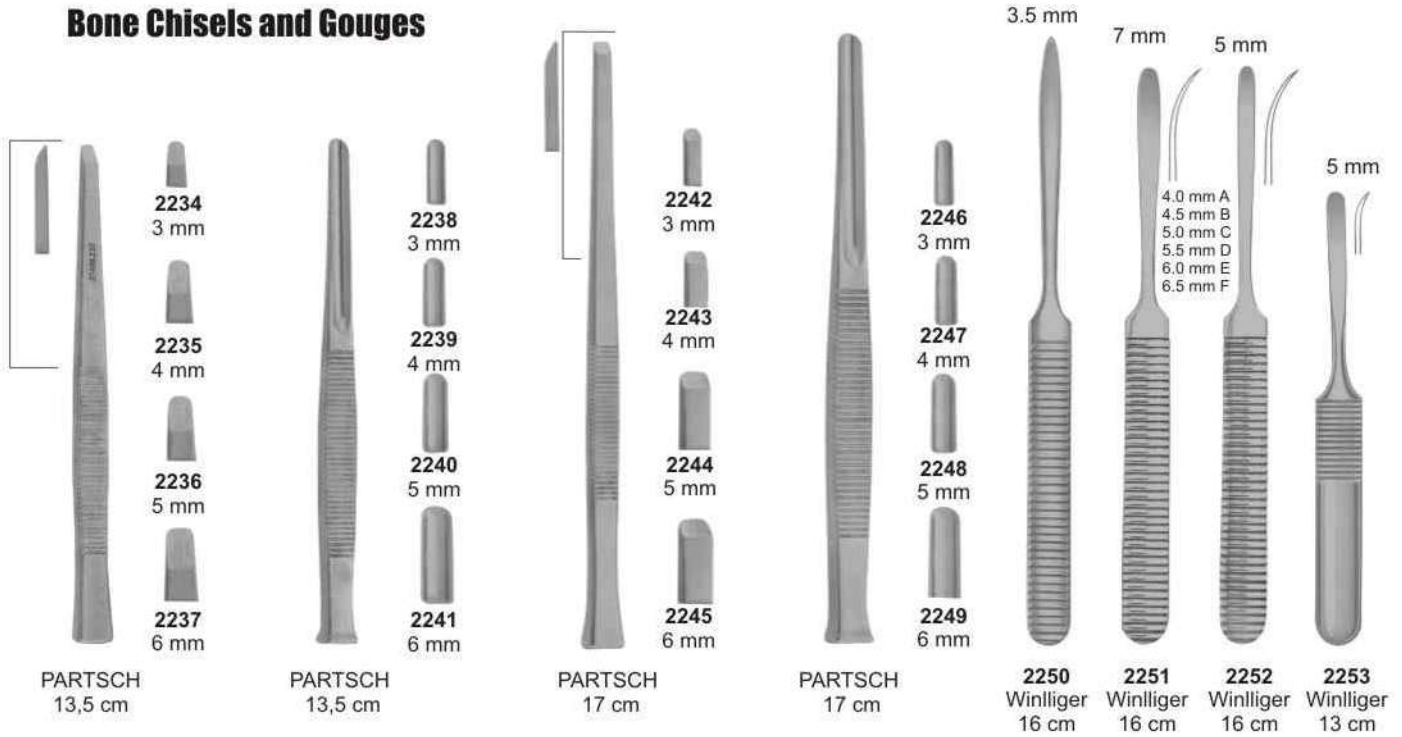

Martelli chirurgici Mallet

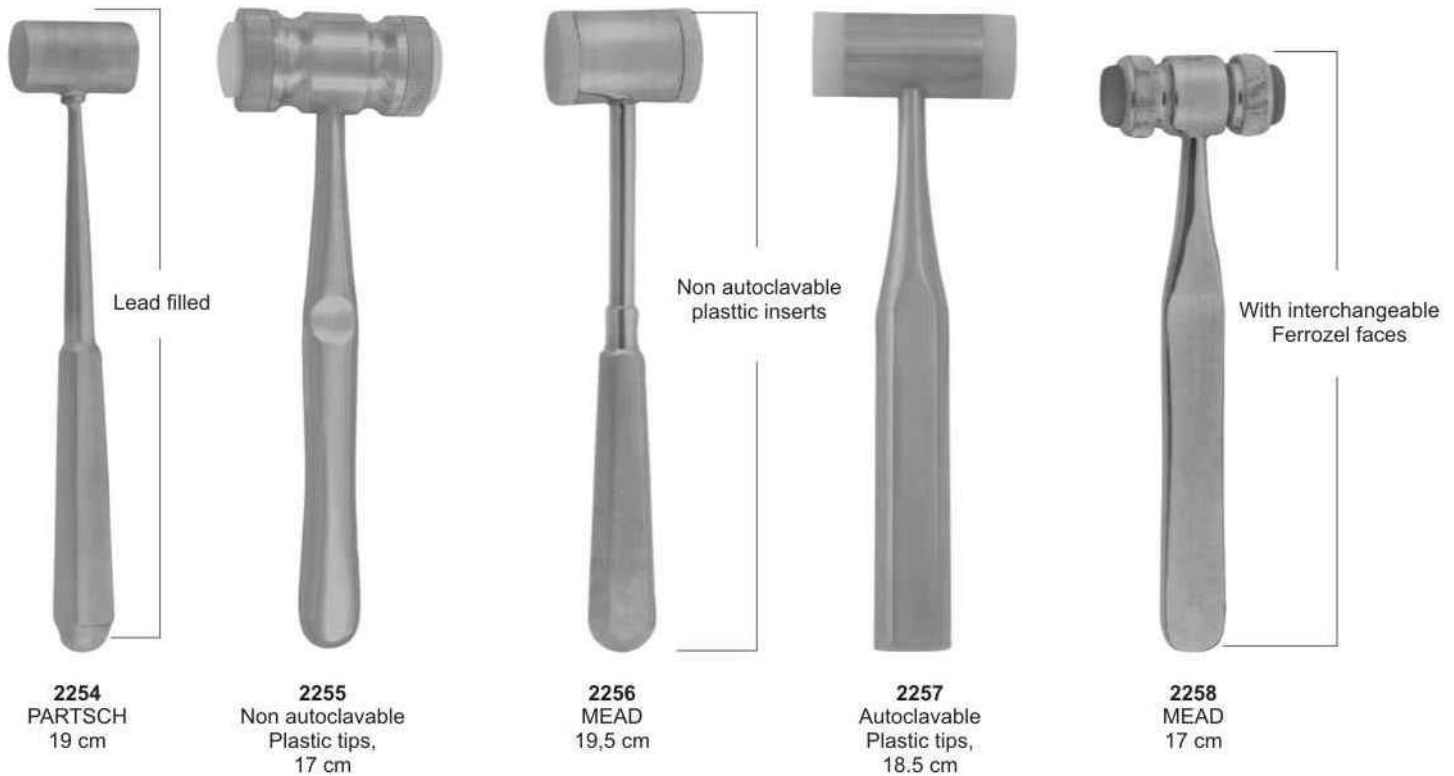

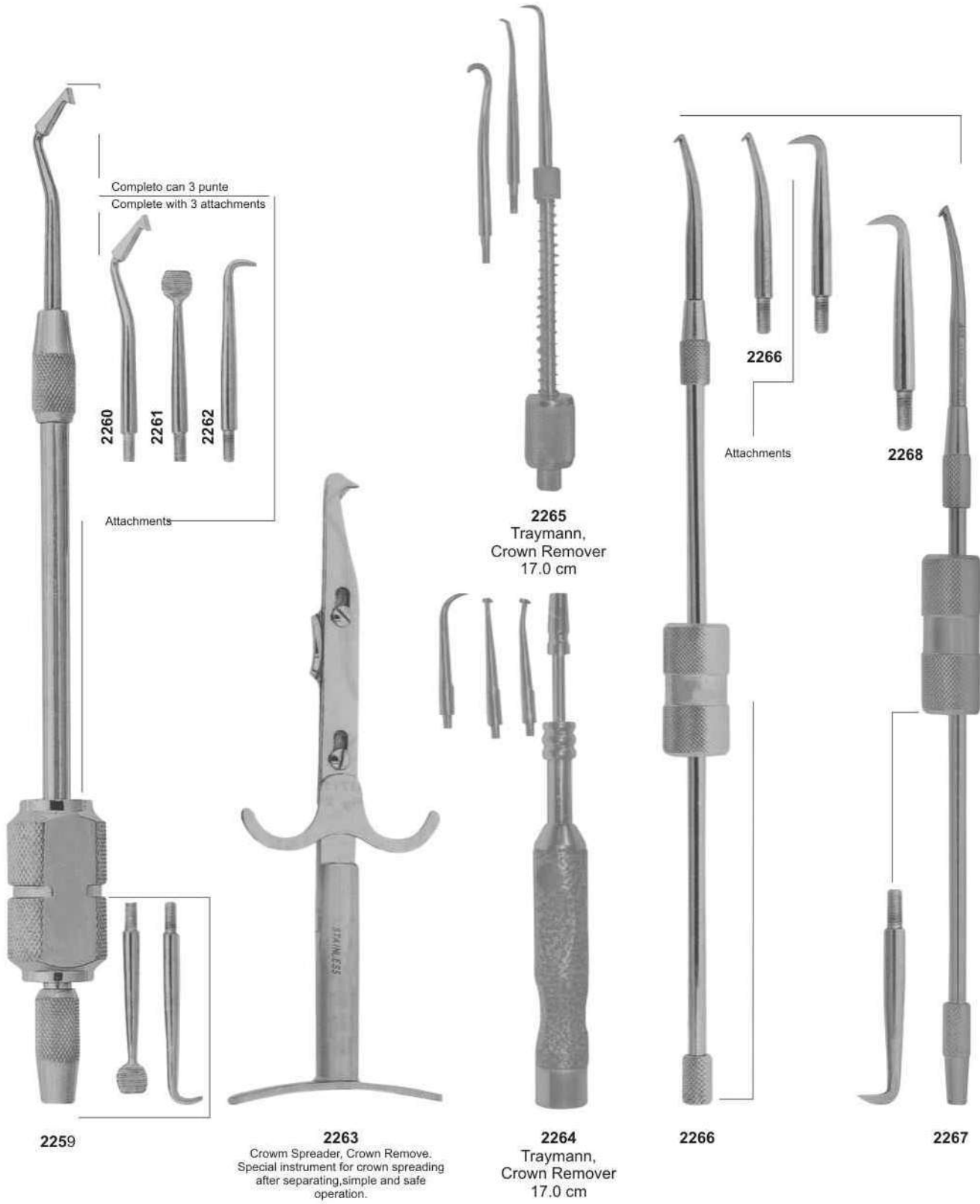

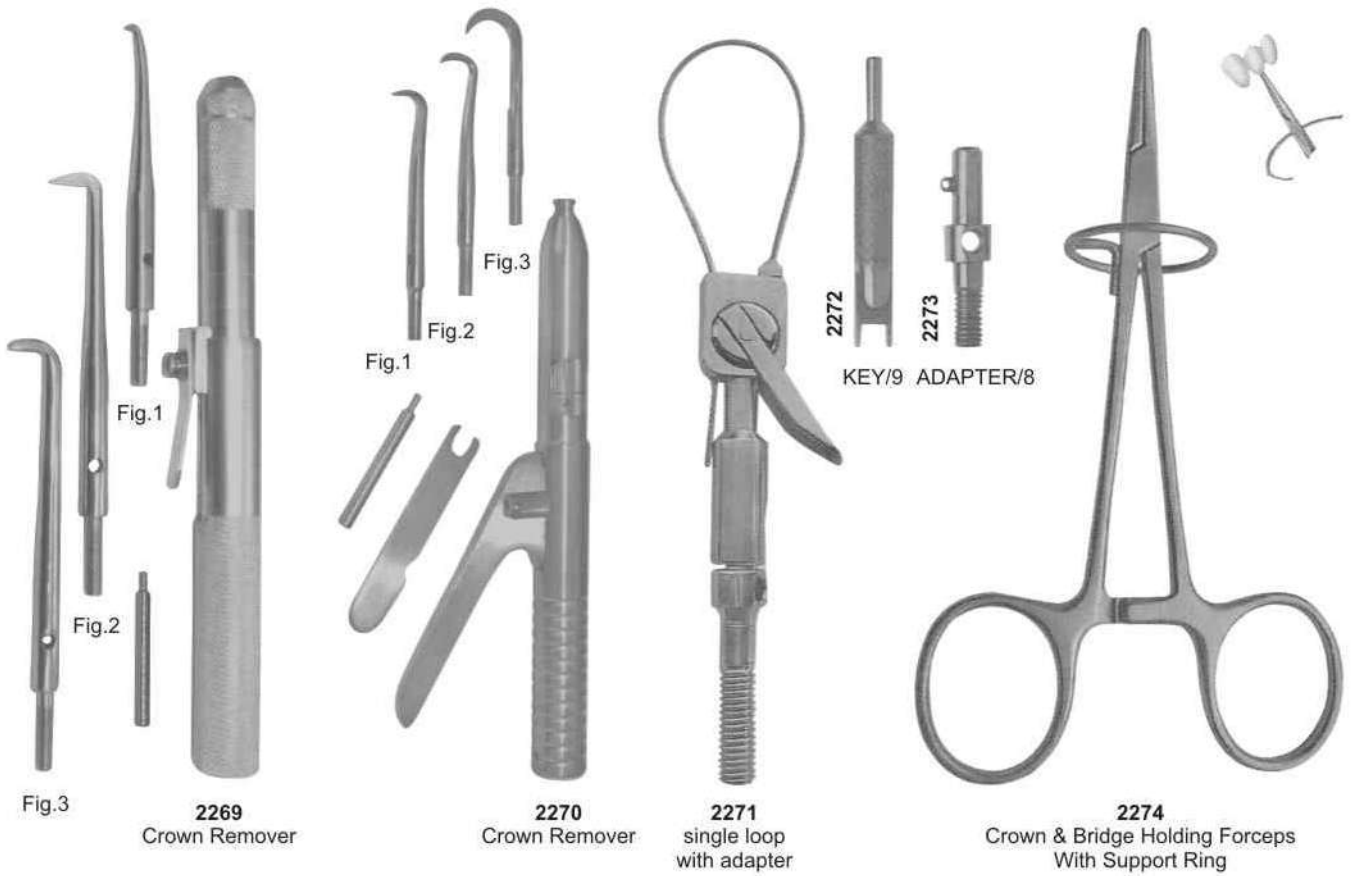



2282
Plaster Shear
210 mm



2283
Crown Removing Plier
14 cm

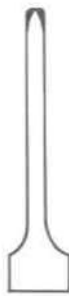

2284
MONTFORT
18 CM



2285
BOHM
16 cm



2286
Telescope Crown
Plier, Diamond coated
13.0 cm



2287
Telescope Crown
Plier, Diamond coated
13.0 cm



2288
Telescope Crown Plier
13.0 cm gerieften Maul
15.0 cm gerieften Maul
13.0 cm gelatts Maul
15.0 cm gelatts Maul



2289
Telescope Crown
Plier, Fine
15.0 cm

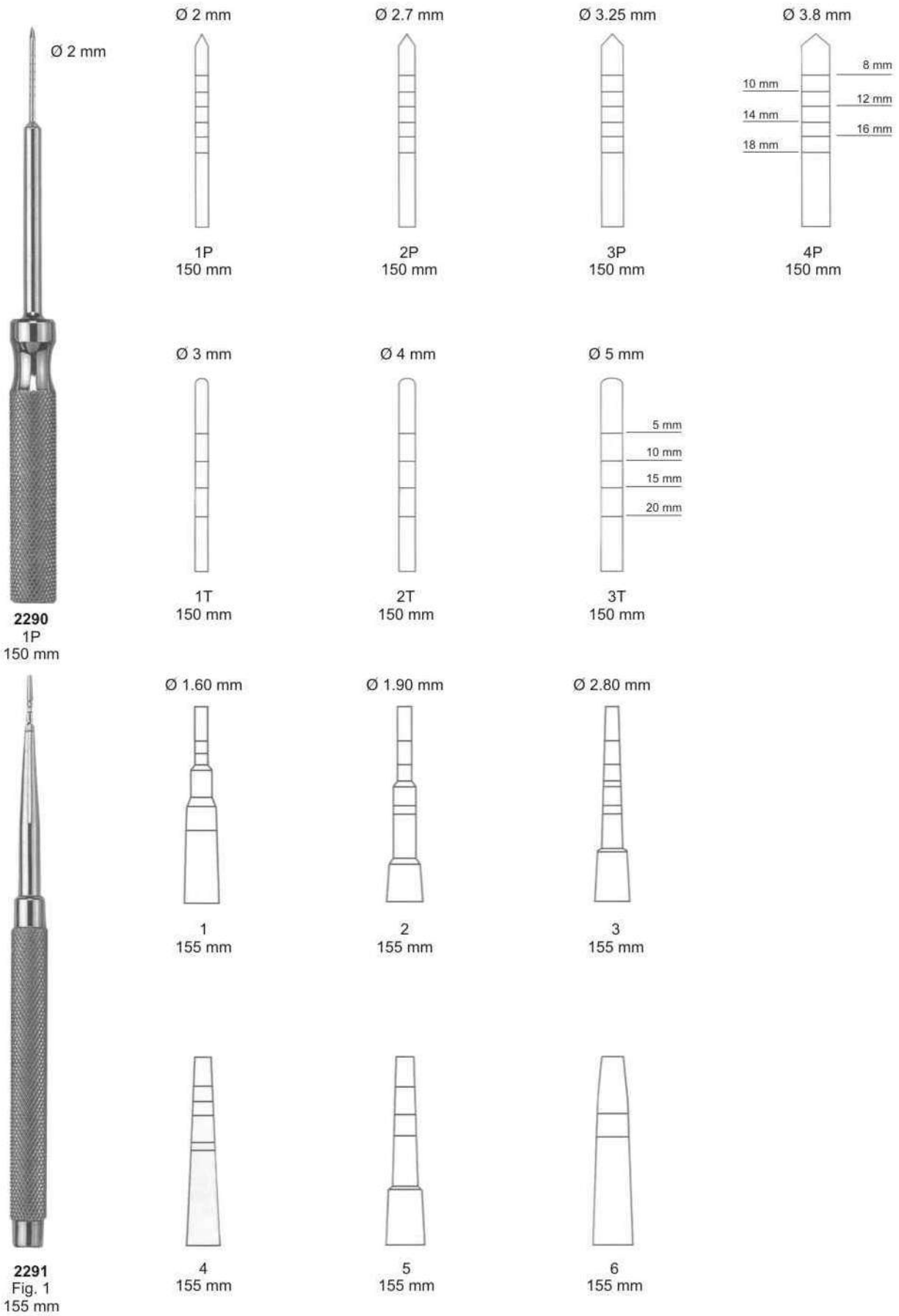



2292
Fig. 1B
165 mm

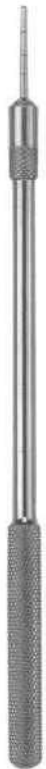
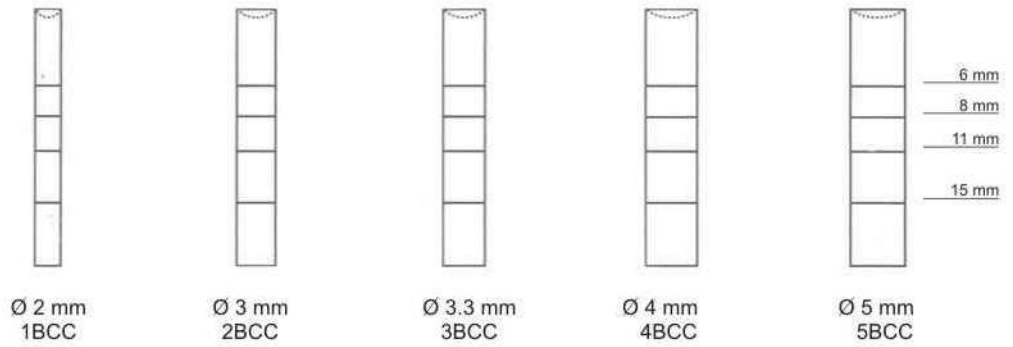
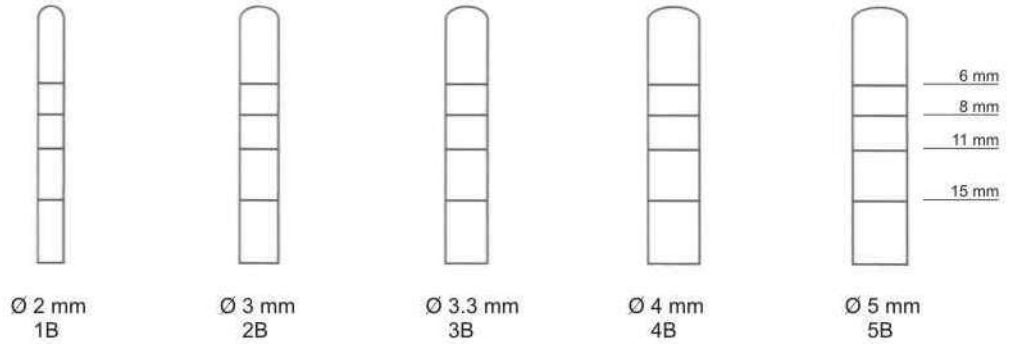

2293
Fig. 1
155 mm

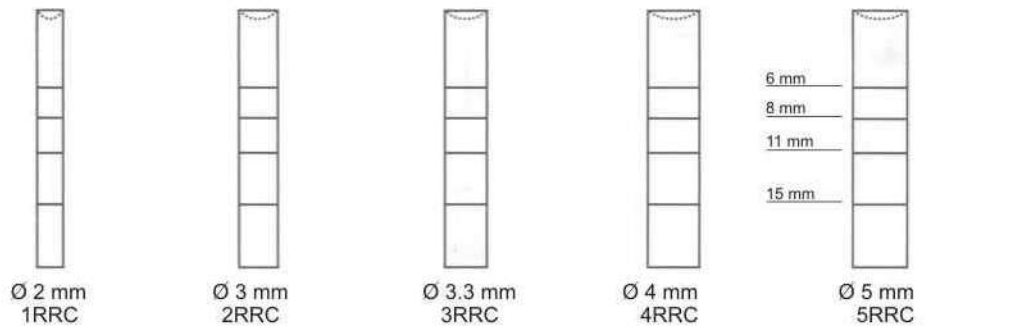
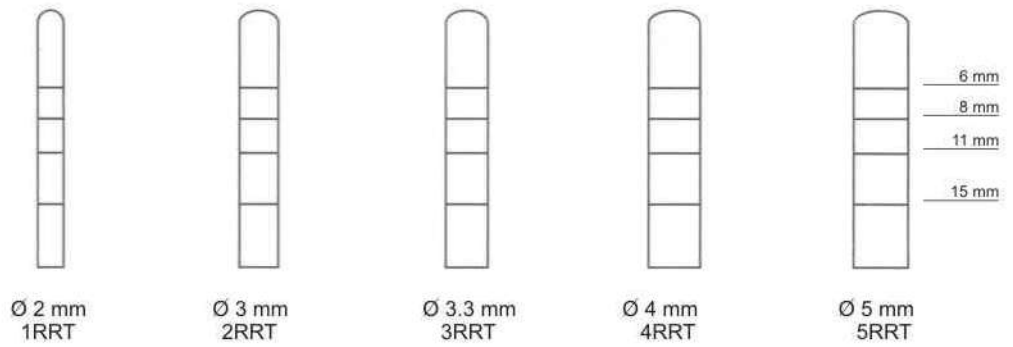

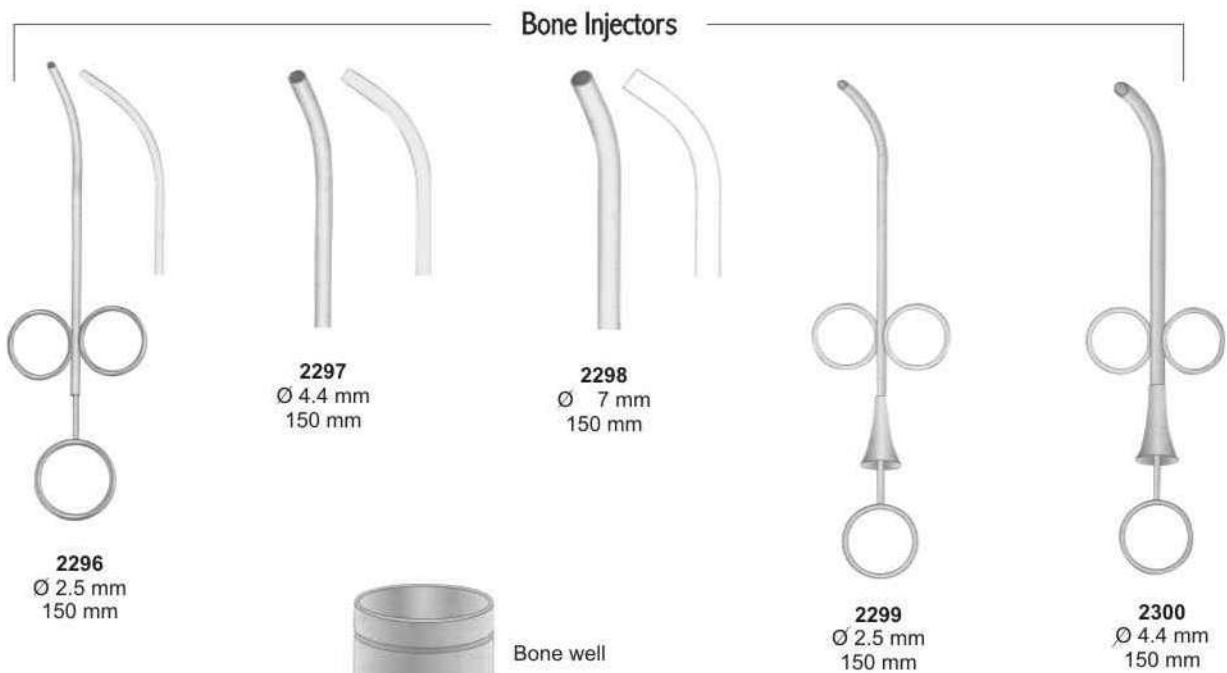
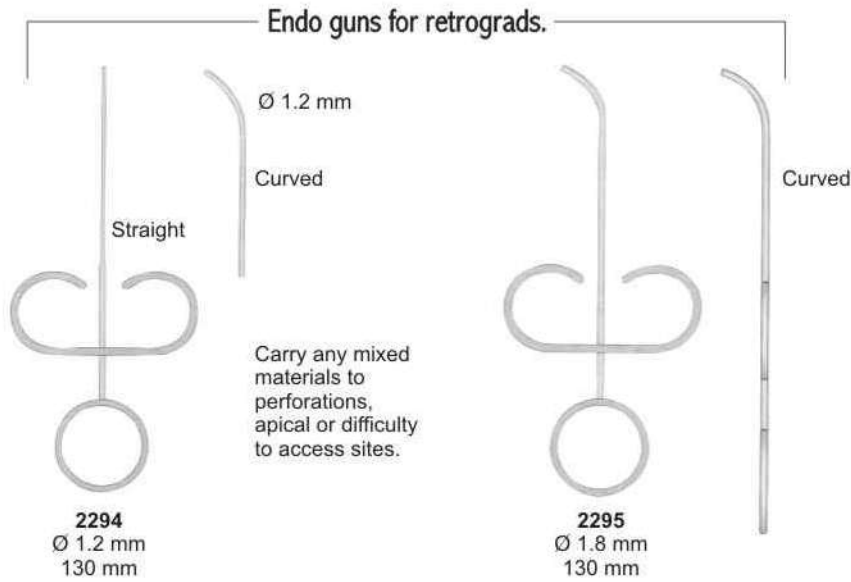

2302
Grinders for autogenous

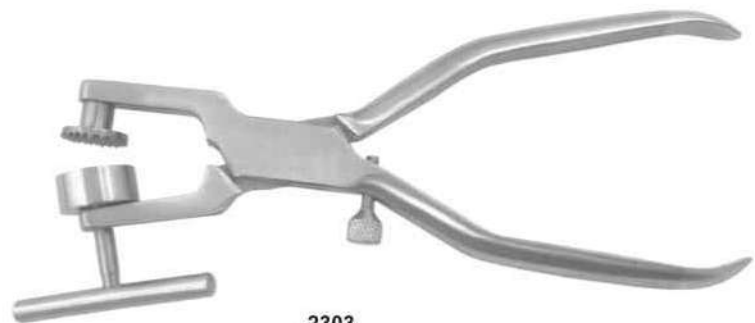

2303
Bone Mill Forcep
17.0 cm

Suction Tubes

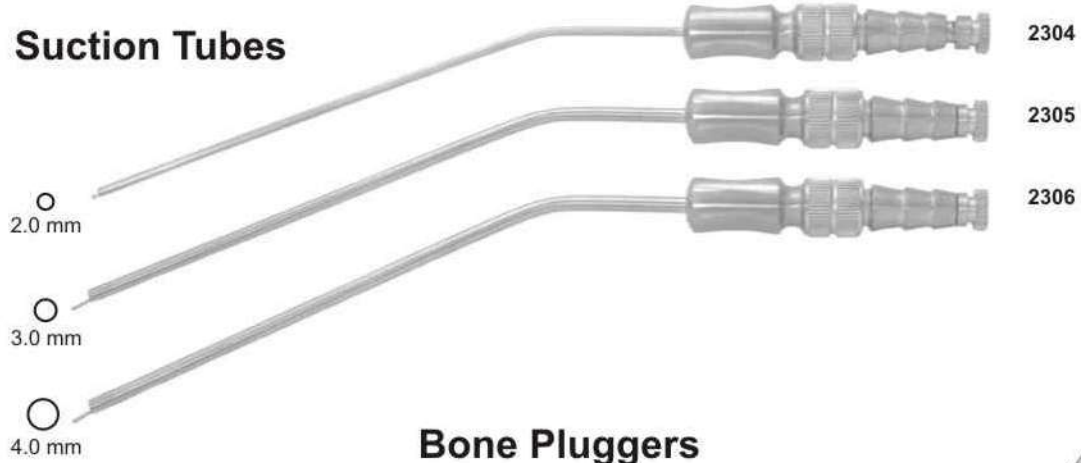

Bone Pluggers



Kerrison Rongeurs



(1.5 mm inside) 2311
(2.0 mm inside) 2312
(3.0 mm inside) 2313
(4.0 mm inside) 2314
(4.5 mm inside) 2315
16.5 cm

(1.0 mm inside) 2316
(2.0 mm inside) 2317
(2.50 mm inside) 2318
16.5 cm



2319
Fig. 1
170 mm

2320
Fig. 2
175 mm

2321
Fig. 3
170 mm

2322
LUCAS
Fig. 88
170 mm

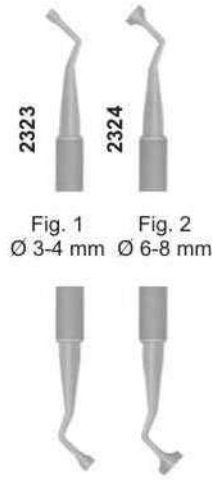
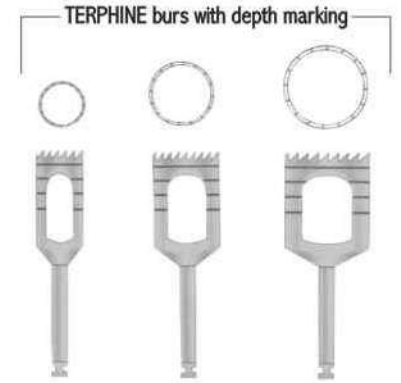

Fig. 1
Ø 3-4 mm

Fig. 2
Ø 6-8 mm

Bone Compactors.



TERPINE burs with depth marking

2325
Ext. Ø 3.5 mm
Int. Ø 3 mm

2326
Ext. Ø 6 mm
Int. Ø 5 mm

2327
Ext. Ø 8.5 mm
Int. Ø 7.55 mm

2328
Ext. Ø 11 mm
Int. Ø 10 mm

Sinus lift instruments

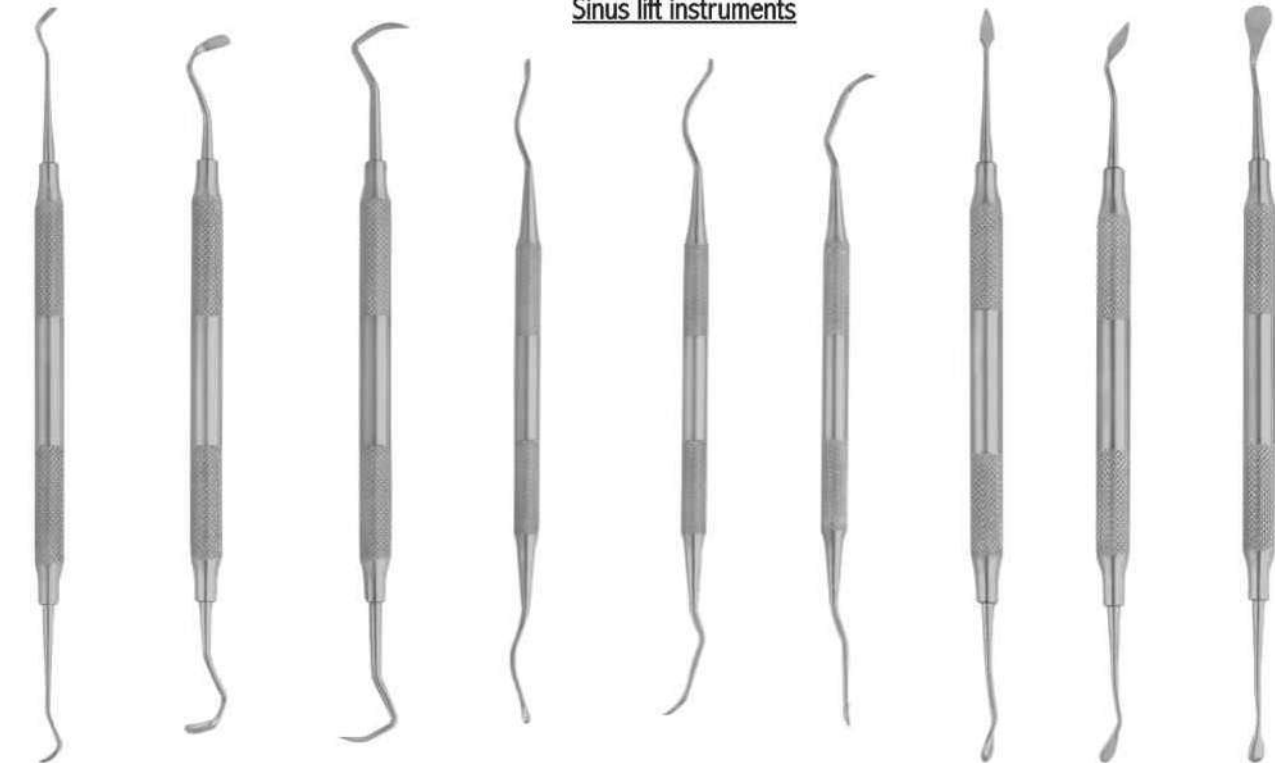

2329
Fig.1

2330
Fig.2

2331
Fig.3

2332
Fig.4

2333
Fig.5

2334
Fig.6

2335
Fig.7

2336
Fig.8

2337
Fig.9

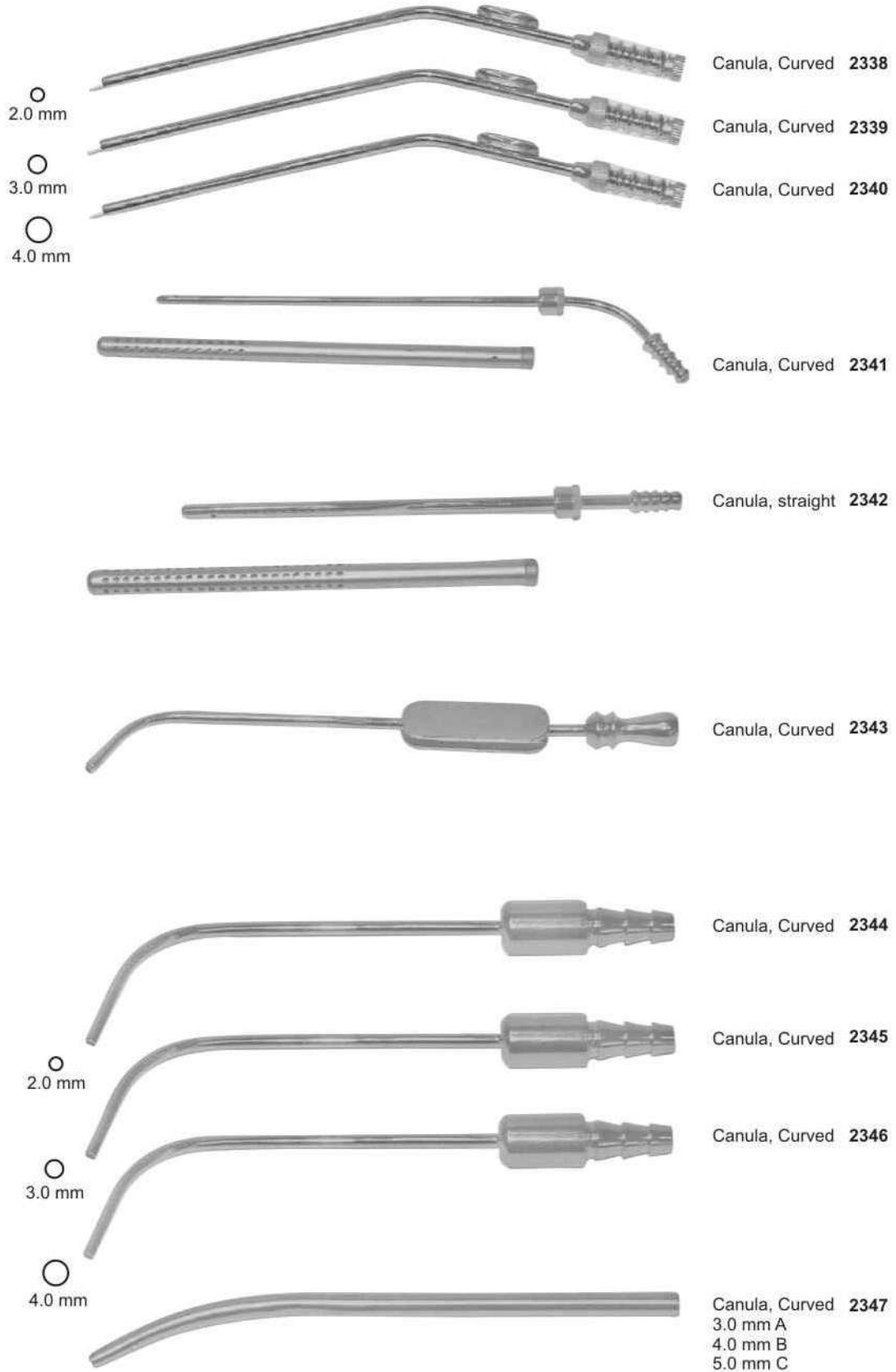

- ﴿ ٲ ﴾ Measuring Instruments
- ﴿ ٲ ﴾ Amalgam Guns & Carriers
- ﴿ ٲ ﴾ Retainers
- ﴿ ٲ ﴾ Rubber Dam Instruments
- ﴿ ٲ ﴾ Syringes
- ﴿ ٲ ﴾ Tweezers
- ﴿ ٲ ﴾ Sterilizing & Lab. Instruments



05

SECTION





2348
BOLEY Gauge



2349
ZURICHER
130 mm



2350
VERNIER
12 cm



2351
VERNIER



2352
VERNIER Gauge



2353
VERNIER Gauge



2355
Finger Ruler



2354
LWANSON
Crown Gauge



2356
LWANSON
Crown Gauge



2357
Sliding Gauge
10 cm



2358
Spring Bow Divider
6" Radius



2359
VERNIER
Gauge



2360
ALBEE



2361
Height Gauge
Wick Type

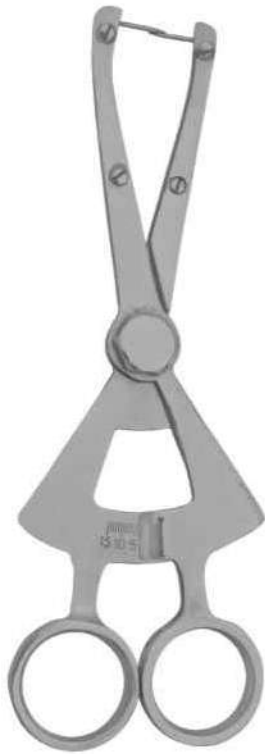

2362
Bone Gauge



2363
Bone Caliper
15 cm



2364
Castroviejo



2365 A
Castroviejo
Curved



2365 B
Straight



2366 C
Castroviejo
Straight

2366 D
Curved



2367
Gauge

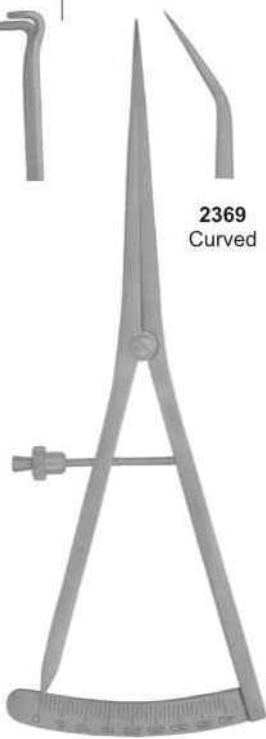

2368
Castroviejo
Straight



2369
Curved

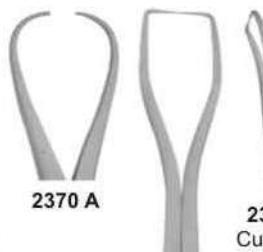

2370 A

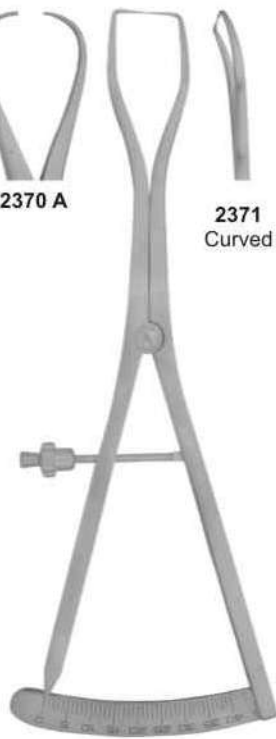

2370
Castroviejo
Straight

2371
Curved



2373
Boone - Gauge



2372
Castroviejo



2374
Curved



2375
Straight



2376
Bracket Gauge. Ant/Post



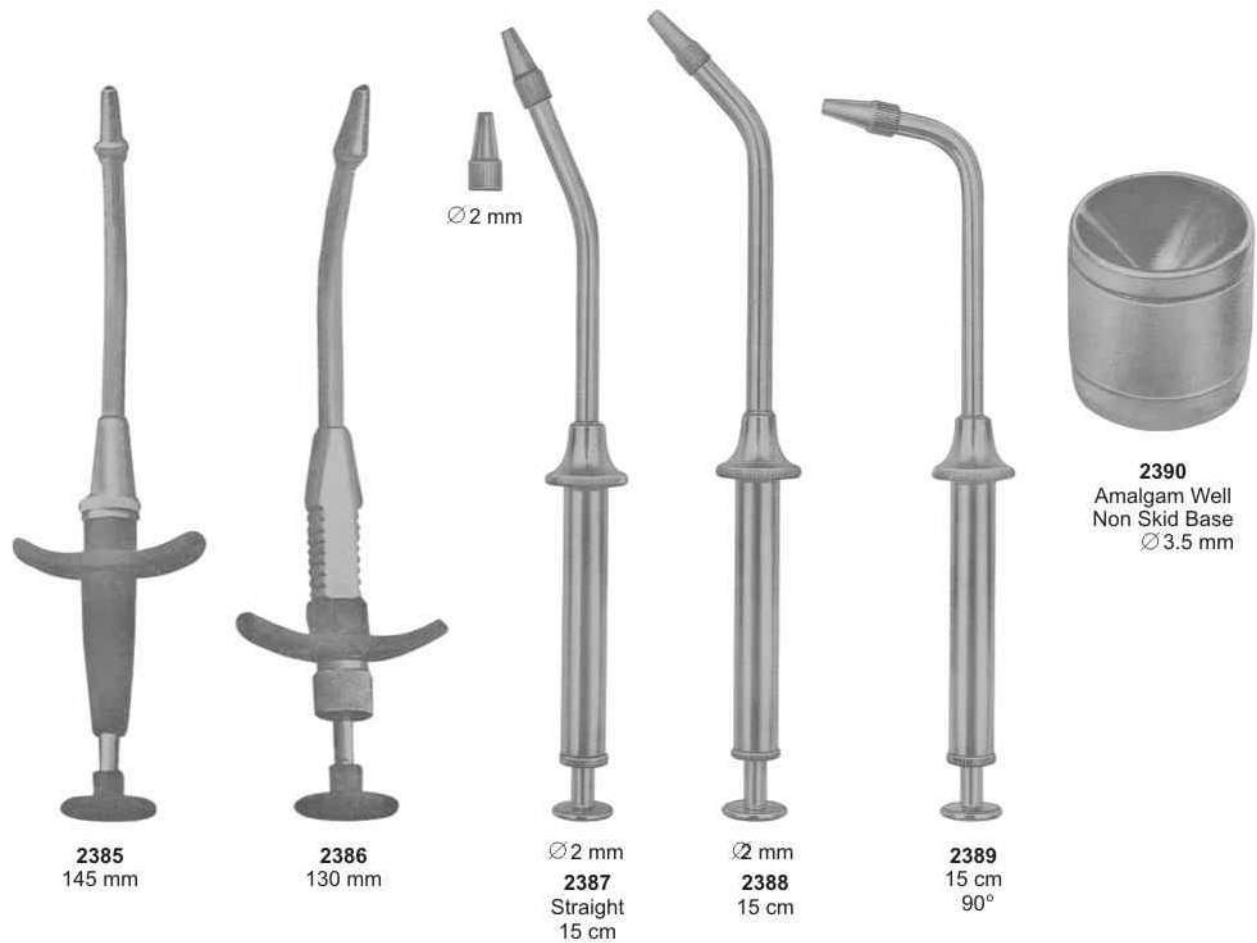
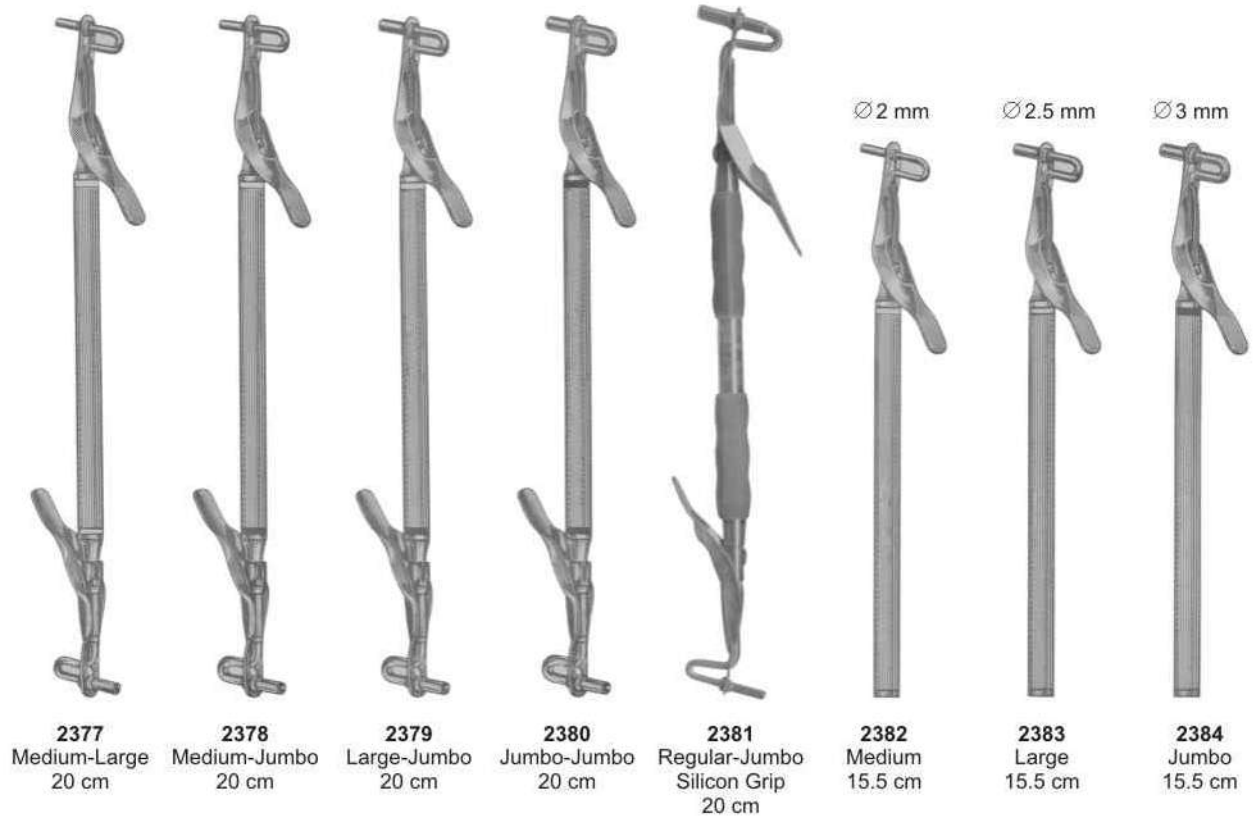

Retainers



2391
No. 1

2392
No. 8

2393
No. 9

"Tofflemire" Type Retainers

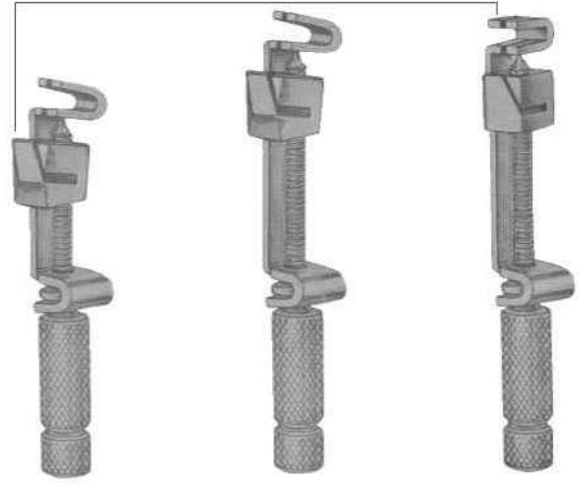

2394
JUNIOR-CA

2395
SENIOR-CA

2396
UNIVERSAL

Tofflemire Bands

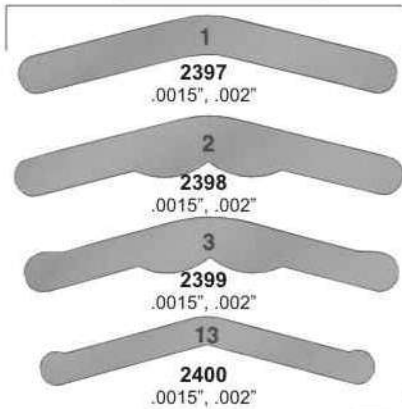

1
2397
.0015", .002"

2
2398
.0015", .002"

3
2399
.0015", .002"

13
2400
.0015", .002"

2401
X-Ray Holder
Small



Set of 10
2402
Film Hanger

Napkin Holders

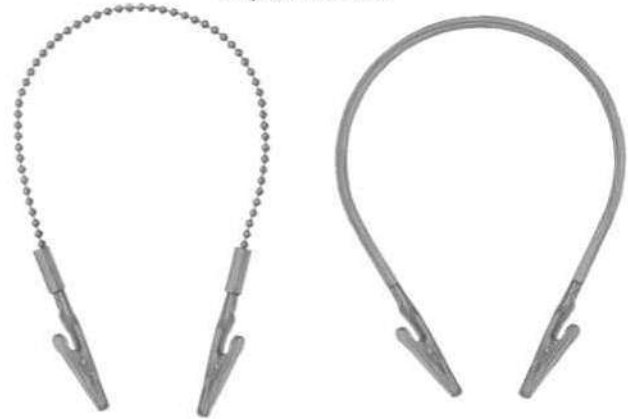

2403
BALL CHAIN

2404
NON-CHILL
Clear Plastic

Strip Holders

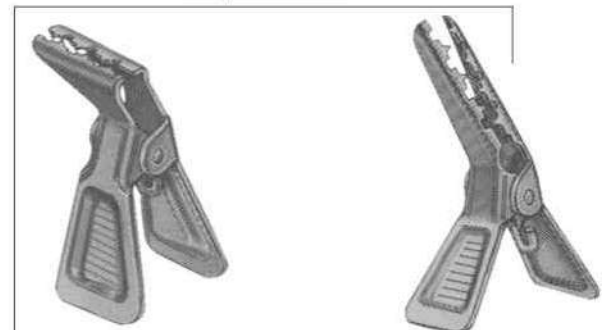

2408
Strip Holder Clip
90°

2409
Strip Holder Clip
45°

2405
Finger Protector
Small

2406
Medium

2407
Large



2410
IRORY
Light weight, 170 mm



2411
BREWER
175 mm



2412
BREWER
175 mm



2413
WHITE
175 mm



2414
IVORY
170 mm



2415
AINSWORTH
Rubber Dam Punch
170 mm



2416
AINSWORTH
Rubber Dam Punch
170 mm



2417
AINSWORTH
Rubber Dam Punch
170 mm

Articulating Paper Forceps



2421
MILLER
Articulating
Forceps
15 cm



2422
MILLER
Articulating
Forceps
15 cm



2418
"IV" Type
Rubber Dam Punch
160 mm



2419
Plastic Rubber Dam
Frame 242

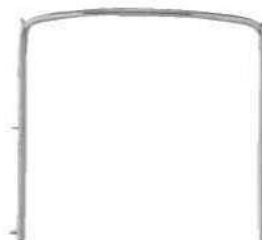

2420
Rubber Dam Holder
Stainless Steel Pins

LOWER MOLARS



2423
76D-W3

2424
76D-3



2429
76D-7A

2430
76D-7



2435
76D-12A

2436
76D-13A



2441
76D-26

2442
76D-28



2445
76D-W8A

2446
76D-8A

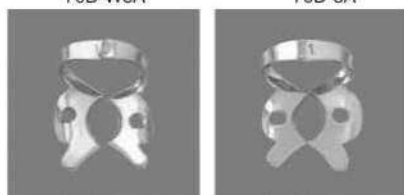

2447
76D-10

2448
76D-11



2451
76D-24

2452
76D-25

UPPER MOLARS



2425
76D-4

2426
76D-5



2431
76D-8

2432
76D-26N



2437
76D-30

2438
76D-31

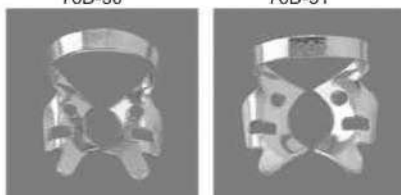

2443
76D-201

2444
205

MOLARS



2449
76D-14

2450
76D-118



2453
76D-27

2454
76D-56



2455
76D-14A

PREMOLARS



2427
76D-0

2428
76D-1



2433
76D-2A

2434
76D-2



2439
76D-27N

2440
76D-29

ANTERIOR



2456
76D-00

2457
76D-1A

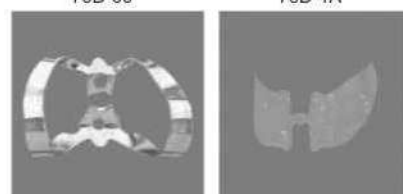

2458
76D-9

2459
76D-212

4969/CO



4969/F



4969/CV

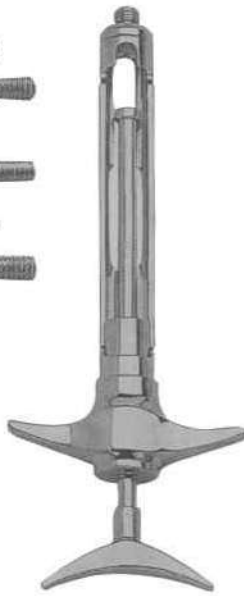

2460
ml 1,8
EU



2461
ml 1,8
EU/AM



2462
ml 1,8
EU/AM



2463
Fig. 1
ml 1,8
EU



2464
Fig. 1
ml 1,8
EU



2465
SS INOX
All inox & autoclavable
black plastic handle
passive automatic
aspiration.



2466
Fig. 1
ml 1,8
EU/Am



2467
Fig. 1
ml 1,8
EU/Am



2468
Fig. 1
ml 1,8
EU/Am



2469
ml 1,2
EU/Am



2470
Water Syringe
complete with
1 cannula (Lure-Lock)



2471
Water Syringe
complete with
1 cannula (Lure-Lock)



2472
Metal Water Syringe
self-filling, with 1
cannula (Lure-Lock)



2473
Sparrel Barrel with
plunger suitable for
syringes



2474
Cannula, only, with
Luer-Lock connector
suitable for syringes



2475
Articulating
Barrel Syringe



2476
ml 1,8



2477
ml 1,8



2478



2479



2480



2481
Fig. 1
ml 1,8 EU



2485
Fig. 1
ml 1,8 EU



2482
Water
point



2483
Water
point



2484
Water
point



2486
ADSON
Curved 14 cm

2487
ADSON
1X2 / 12 cm

2488
ADSON
12 cm

2489
MICRO ADSON
15 cm

2490
STANDARD
14,18,25 cm

2491
CUSHING
18 cm

2492
Curved

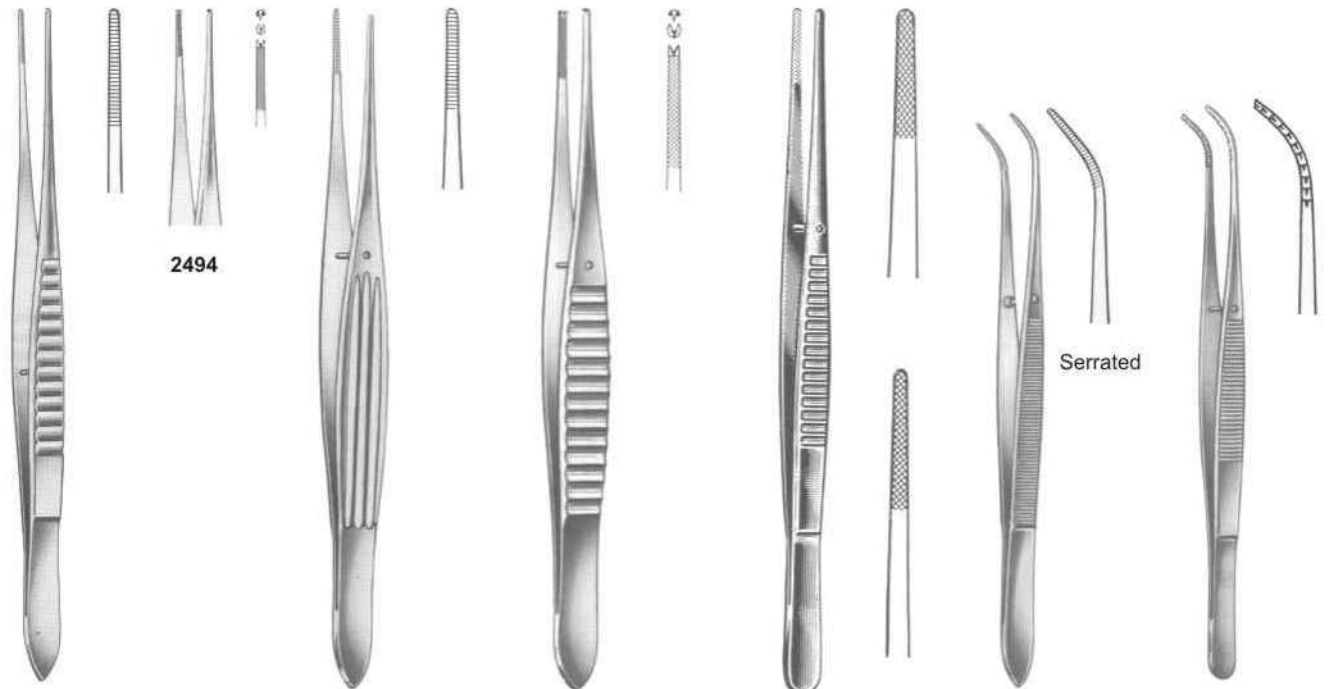

2494

2493
SELECT
15,18,20 cm

2495
MCINDOE
15 cm

2496
GILLIES
15 cm

2497
WAUGH
15,20 cm

2498
PERRY
13 cm

Serrated

2499
KOPP
15.5 cm



2500
COLLEGE
15 cm



smooth



2501
COLLEGE
15 cm



serrated



2502
COLLEGE
15 cm



smooth



2503
COLLEGE
15 cm



serrated



2504
COLLEGE
15 cm



smooth



2505
COLLEGE
15 cm



serrated



2506
COLLEGE
15 cm



smooth



2507
COLLEGE
15 cm



serrated



2508
MERIAM
16 cm



smooth



2509
MERIAM
16 cm



serrated



2510
MERIAM
16 cm



smooth



2511
MERIAM
16 cm



serrated



2512
MERIAM
16 cm



smooth



2513
MERIAM
16 cm



serrated



2514
MERIAM
16 cm



smooth



2515
MERIAM
16 cm



serrated

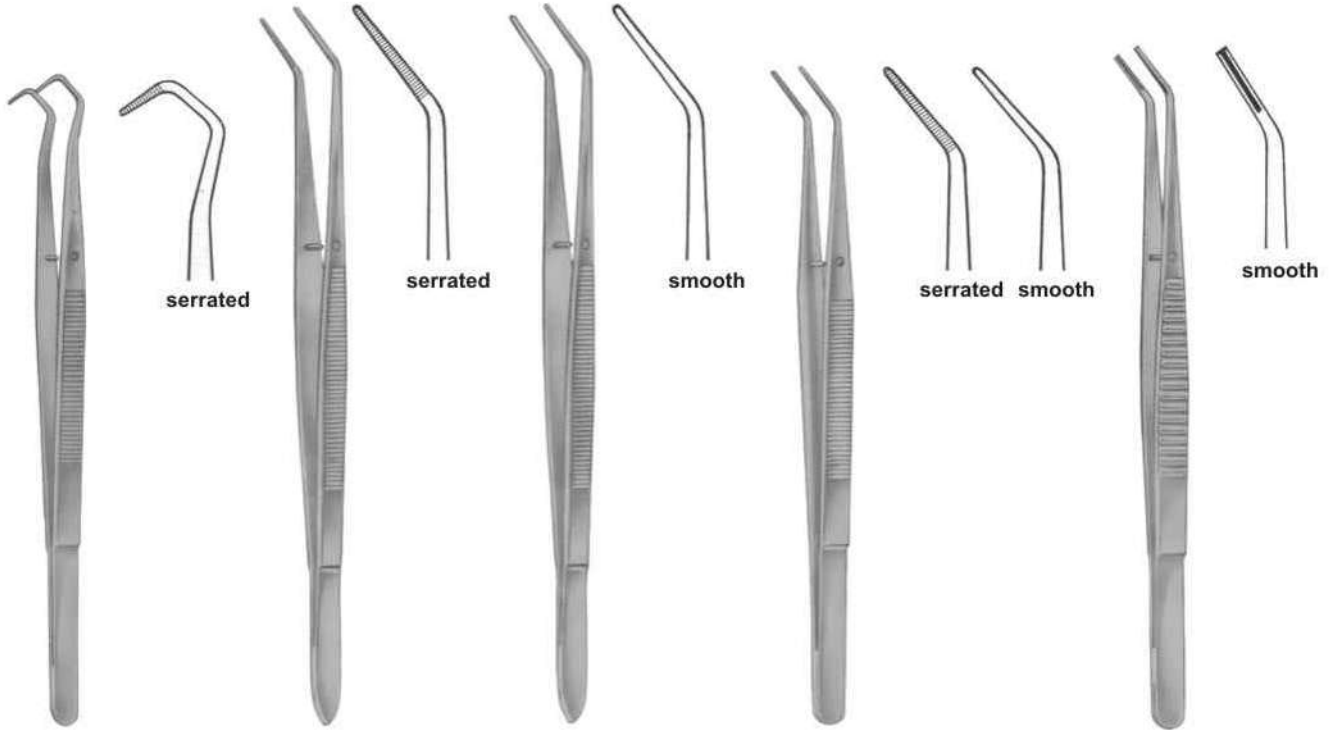

2516
COLLEGE
14.5 cm, 5³/₄"

2517
FLAGG
16 cm, 6¹/₄"

2518
FLAGG
16 cm, 6¹/₄"

2519
LANDGRAF
15 cm, 6"

2520
15.5 cm, 6¹/₈"

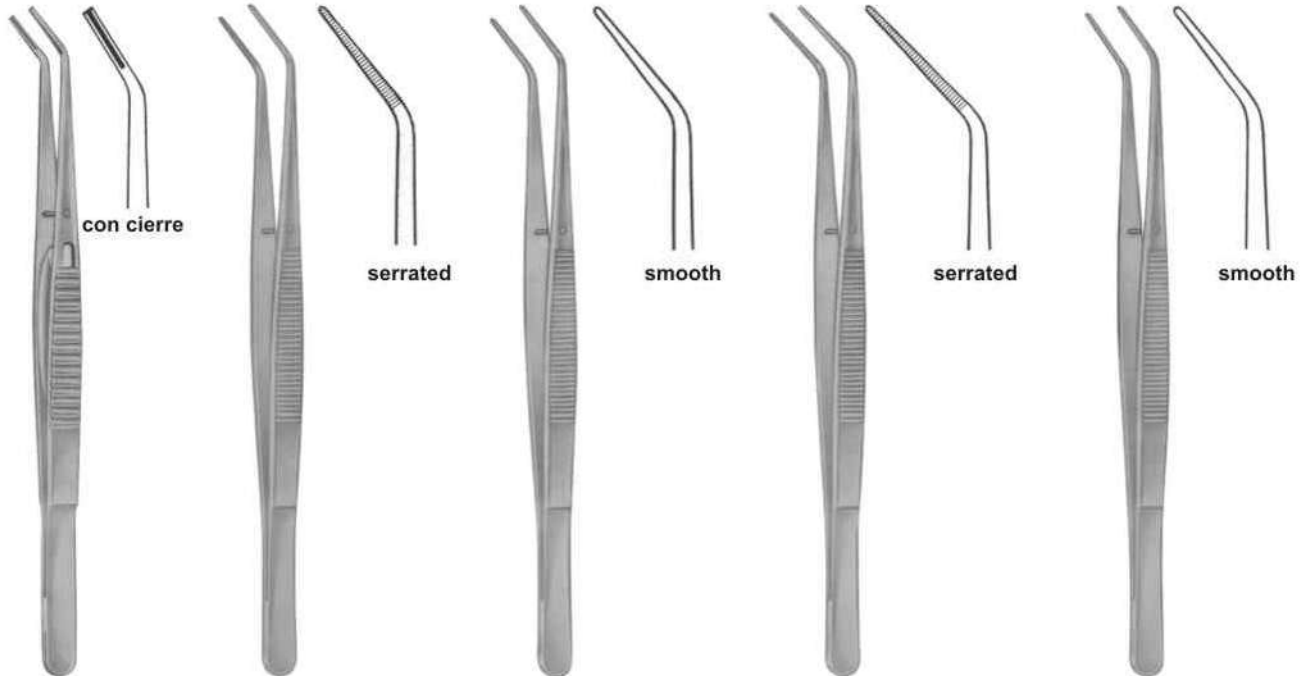

2521
15.5 cm, 6¹/₈"

2522
LONDON-COLLEGE
15 cm, 6"

2523
LONDON-COLLEGE
15 cm, 6"

2524
LONDON-COLLEGE
15 cm, 6"

2525
LONDON-COLLEGE
15 cm, 6"



2526
LONDON-COLLEGE
15 cm, 6"



2527
LONDON-COLLEGE
15 cm, 6"

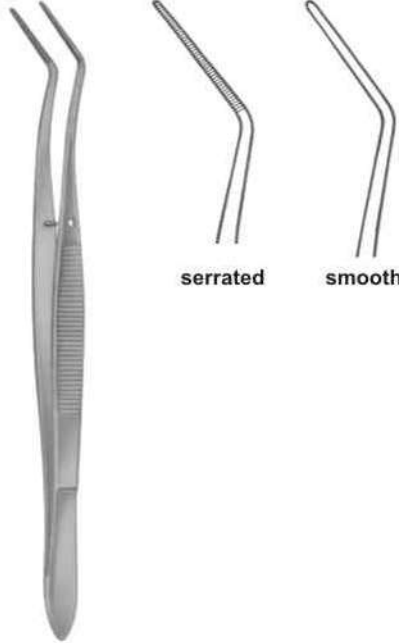

2528
MERIAM
16 cm, 6 1/4"



2529
ALLEN
18 cm, 7 1/8"

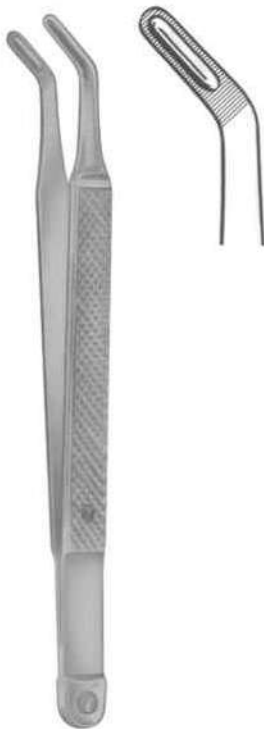

2530
ALBRECHT
16 cm, 6 1/4"



2531
ALBRECHT
16 cm, 6 1/4"



2532
16 cm, 6 1/4"



2533
16 cm, 6 1/4"

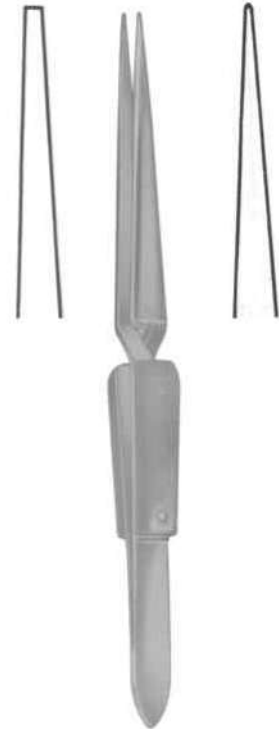

2534
16 cm, 6 1/4"

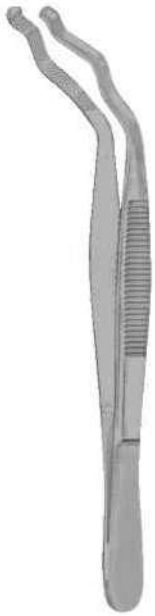

2535
DAVIS
6"



2536
Grasping Forceps
6 1/4"



2537
Mesh Bur & Diamond Holder
Large, 2 1/8" Diameter



2538
Soldering Tweezers
6 1/4"



2539
Narrow Fine
4 3/4"



2540
Super Fine
4 3/8"



2541
Fine Curved
4 1/2"



2542
Bonding Bracket
Holder
136 mm



2543
Bonding Bracket
Holder
135 mm



2544
Bonding Bracket
Holder
135 mm



2545
Bonding Bracket
Holder
140 mm

- ⟨☞⟩ Endodontic Forceps
- ⟨☞⟩ Tissue Forceps
- ⟨☞⟩ Retractors
- ⟨☞⟩ Mouth Gags



06

SECTION





2546
Endo Forceps
4 3/4"



2547
PEETS Forceps
4 3/4", Useful For
Removing Broken
Instruments

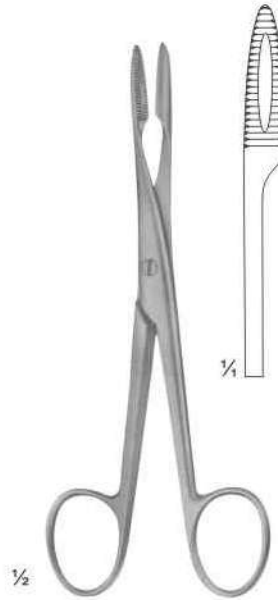

2548
Without Ratchet
145 mm

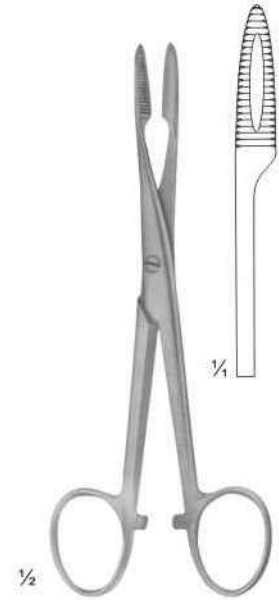

2549
With Ratchet
145 mm

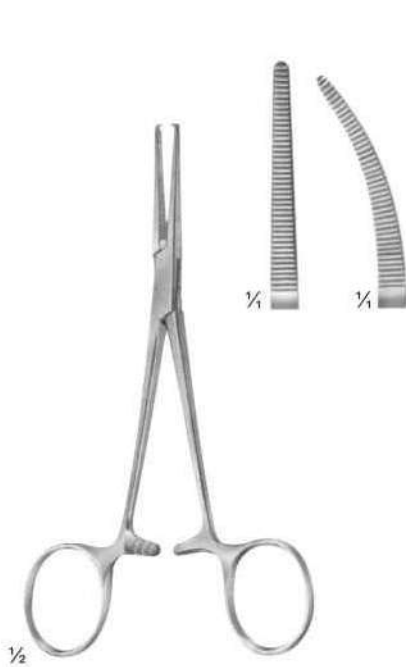

2550
CRILE
140 mm

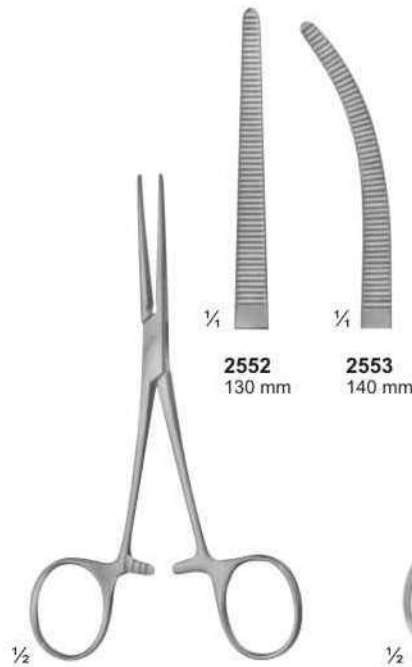

2551
PEAN
Slender type

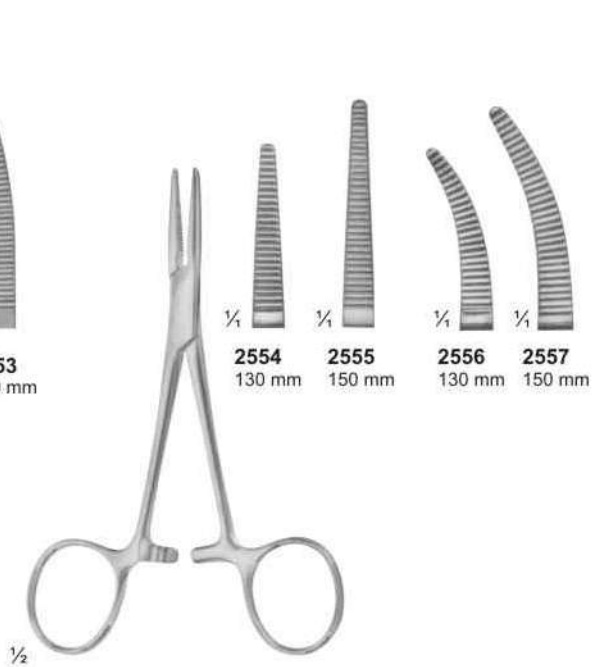

2554
SPENCER-WELLS



2558
BABY-ALLIS
5", Straight
4x5 teeth extra delicate



2559
ALLIS
6", Straight
4x5 teeth extra delicate



2560
ALLIS
6", Straight
4x5 teeth extra delicate



2561
1x2 teeth
6"



2562
SEMKIN
6", Straight,
1x2 teeth



2563
ADSON
4 3/4"
1x2 teeth



2564
BROWN-ADSON
4 3/4"
7x7 teeth



2565
BROWN
6"
8x8 teeth



2566
RUSSIAN
6"
8x8 teeth



2567
Extra-Delicate,
Straight, 4"
1x2 teeth



2568
HALSTED-MOSQUITO
Straight, Curved, 5"



2569
HALSTED-MOSQUITO
Straight, Curved, 5"
1x2 teeth



2570
HALSTED-MOSQUITO
Jaws 45 Angled on Flat, 5"
Extra Delicate



2571
KELLY
5 1/2", Straight



2572
JONES
3 1/2"



2573
BACKHAUS
3 1/2"



2574
BACKHAUS
5 1/4"



2575
LORNA
Non Perforated
3 1/2"



2576
DENHART



$\frac{1}{2}$
2577
DENHART
Mouth Gag With
Silicon Inserts,
Interchangeable
Size: 125 mm

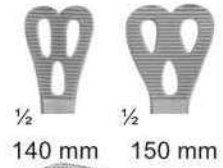

$\frac{1}{2}$ $\frac{1}{2}$
140 mm 150 mm



$\frac{1}{2}$

2578
WIEDER
Tongue depressor
2579 140mm
2580 150mm

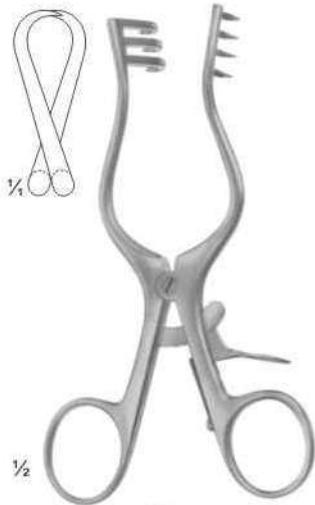

$\frac{1}{4}$

$\frac{1}{2}$

2583
WEITLANER
Sharp
130 mm

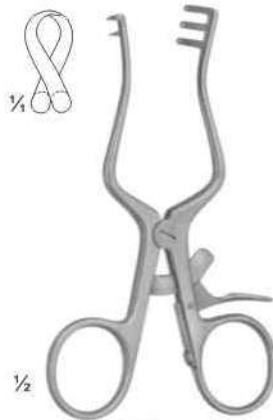

$\frac{1}{4}$

$\frac{1}{2}$

2584
WEITLANER
Sharp
110 mm

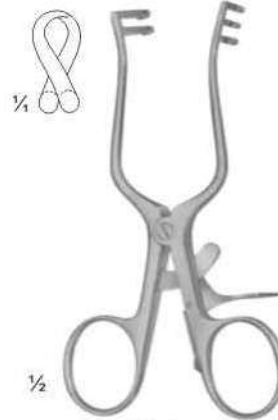

$\frac{1}{4}$

$\frac{1}{2}$

2585
WEITLANER
Semi-Sharp
110 mm



$\frac{1}{2}$

2581
TOBOLD
Tongue depressor
Size: 145 mm



$\frac{1}{2}$

2582
ANDREW
Tongue depressor
Size: 110 mm



2586
MOLT
Pediatric



2587
MOLT
Child



2588
MOLT
Adult



$\frac{1}{2}$

2589
FERGUSON-ACKLAND
Mouth Gag
Size: 145 mm



$\frac{1}{2}$

2590
ROSER KOENIG
Mouth Gag
Size: 160mm / 185mm

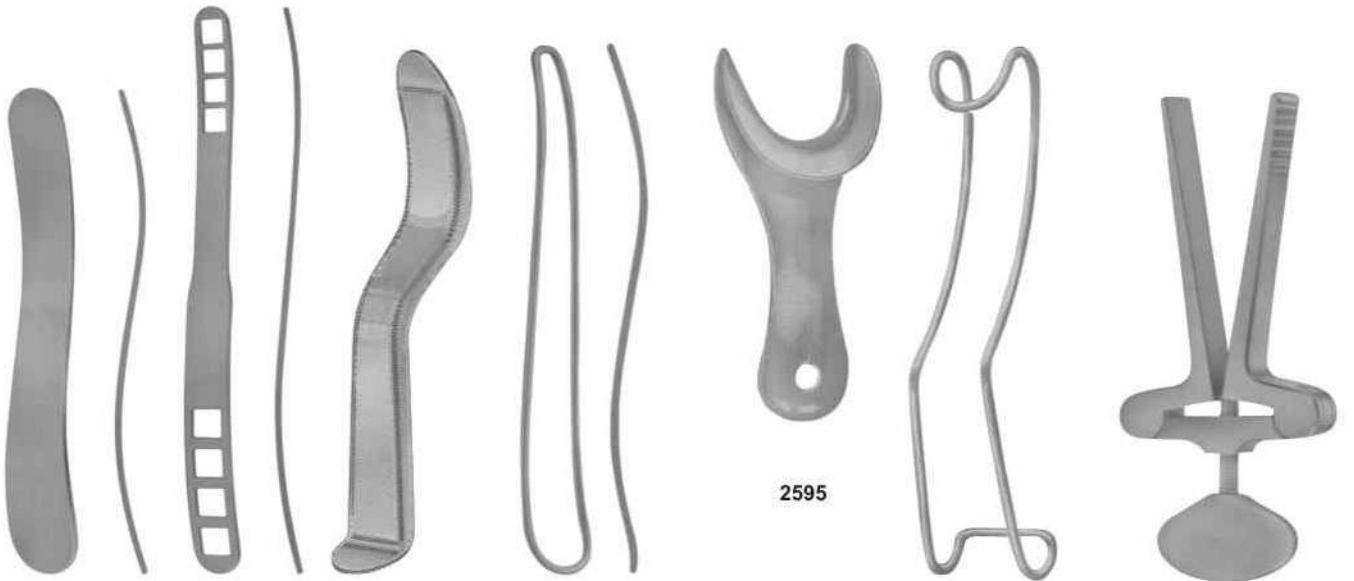

2591
140 mm

2592
BRUENINGS
190 mm

2593

2594

2595

2596

2597

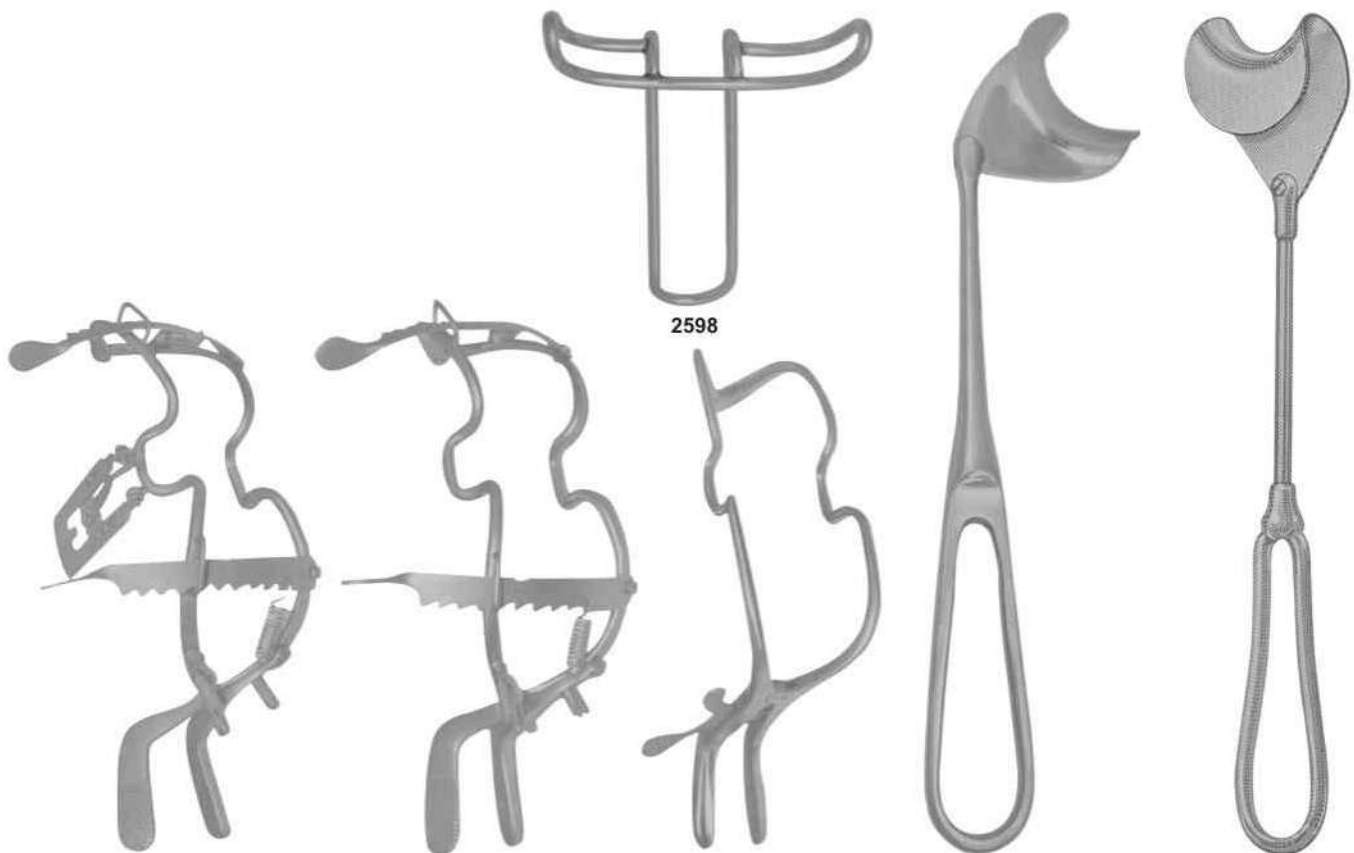

2598

2599
Mouth Gag with
Tongue Depressor
11.0 cm
13.0 cm
15.0 cm

2600
Mouth Gag without
Tongue Depressor
11.0 cm
13.0 cm
15.0 cm

2601
Jennings, Mouth Gag
11.0 cm
13.0 cm
15.0 cm

2602

2603

- 30 x 4 mm A
- 23 x 7 mm B
- 24 x 11 mm C
- 29 x 10 mm D
- 30 x 11 mm E
- 32 x 14 mm F
- 40 x 11 mm G
- 42 x 10 mm H
- 50 x 11 mm I
- 55 x 11 mm J
- 60 x 11 mm K
- 70 x 11 mm L
- 70 x 14 mm M

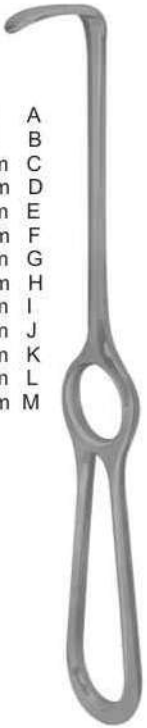

2604
LANGENBECK
210 mm



2605
KOCHER-LANGENBECK
215 mm



2606
BUCHS
205 mm



38 x 18 mm



2607
KOCHER
230 mm



2608
MIDDELDORPF



2609
15 x 15 mm
220 mm



2610
20 x 22 mm
215 mm



2611
28 x 28 mm
235 mm



2612
KOCHER
230 mm



2613
COLLIN
150 mm



2614
ROUX
Set
165 mm



2615
Sterilizing Forcep Curved
20 cm A
25 cm B
30 cm C



2616
Sterilizing Forcep Straight
20 cm A
25 cm B
30 cm C



2617
Sterilizing Forcep
30 cm



2618
Becht Tweezer



2619
Sterilizing Forcep
23 cm A
30 cm B



2620
Sterilizing Forcep
20 cm





2621
3 sharp prongs



2622
2 sharp prongs
6"



2623
2 sharp prongs
6"



2624
FOMON
145 mm



2625
ALM
70 mm



2626
SENN
3 sharp prongs
6 3/8"



2627
TOENNIS
Dura Retractor
150mm



2628
JOSEPH
165 mm



2629
GILLIES
180 mm

- Orthodontic Pliers
- Orthodontic Cutters
- Rongeurs
- Needle Holders



07

SECTION





2630
Light Wire Cutter



2631
Wire Cutter



2632
Posterior Band Remover
Long



2633
Posterior Band Remover
Short



2634
Jarabak Plier
Short



2635
Distal End Cutter
Safety End Cutter



2636
Distal End Cutter



2637
Kim's Plier



2638
Loop Forming Plier



2639
Tweed Arch Bending Plier



2640
Utility Plier



2641
Bonding Bracket Remover



2642
Lingual Arch Plier



2643
Light Wire Plier



2644
Wire Cutter
12.5 cm



2645
Fig. 101
Wire Bending

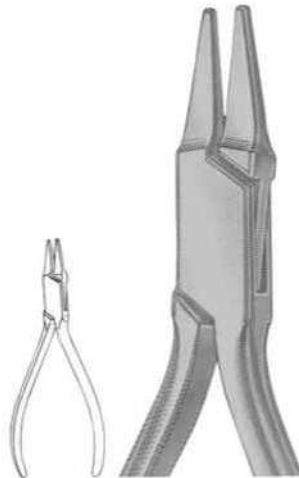

2646
Fig. 118
PEESO
Collar



2647
Fig. 417
Crown Shell

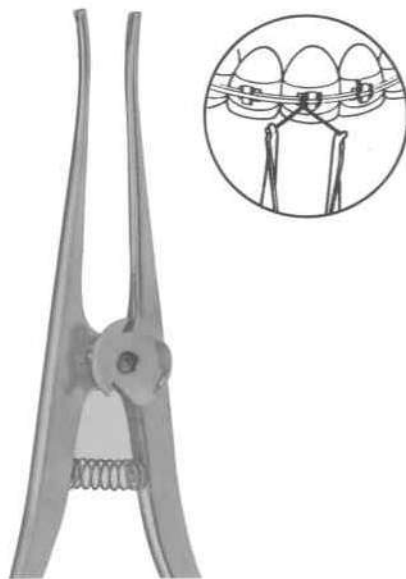

2648
STEINER
150 mm
Ligature Pliers

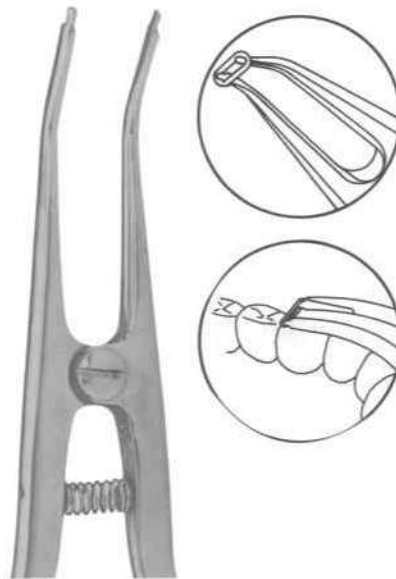

2649
Separating Pliers Elastics
150 mm

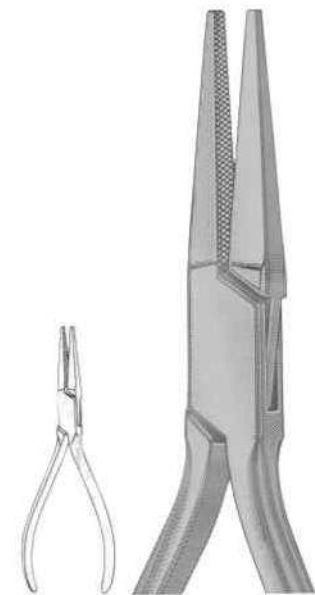

2650
121-Lab & Office



2651
How Plier-Titanium Alloy
With special coated beaks

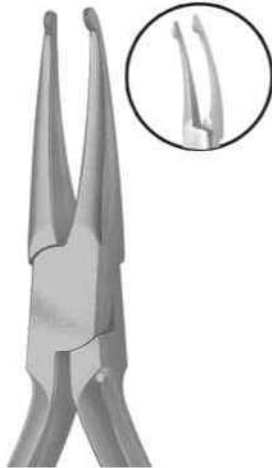

2652
How Plier
Tips are 1/8" (3.2mm)
diameter



2653
How Plier
Tips are 1/8" (3.2mm)
diameter



2654
How Plier-Small
Tips are 3/32" (2.4mm)
diameter



2655
How Plier-Offset
Tips are 1/8" (3.2mm)
diameter



2656
Weingart Utility Plier
-Titanium Alloy
with special coated beaks

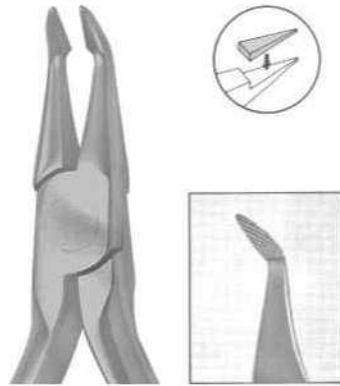

2657
Weingart Utility Plier
New type of the Weingart Utility Plier
designed for a more precise operation.



2658
Weingart Utility Plier

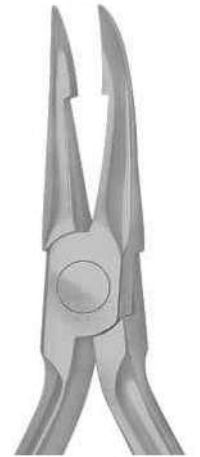

2659
Weingart Utility Plier

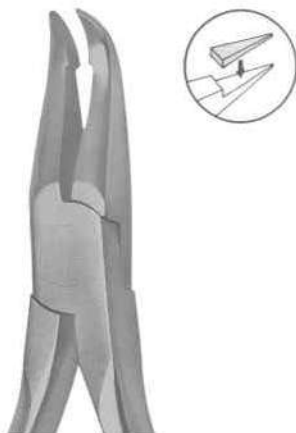

2660
Weingart Utility Plier

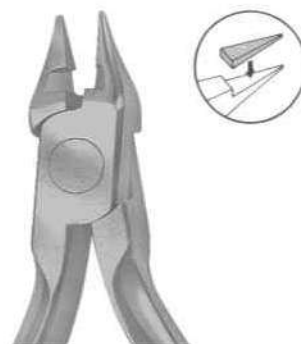

2661
Bird Beak Plier With Cutter
**Maximum Bending &
Cutting Capacity:**
Wires up to .032"

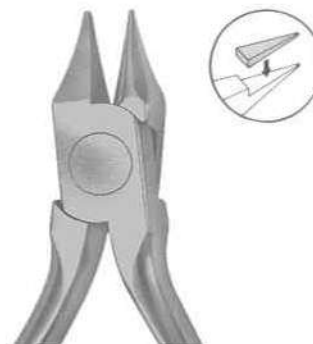

2662
Bird Beak Plier
Maximum Bending Capacity:
Wires up to .032"



2663
Bird Beak Plier
**Maximum Bending
Capacity:**
Wires up to .030"



2664
TWEED (Fig. 98)
13 cm, 5 1/8"
Tweed Loop Omega Pliers.



2665
TWEED - (Fig. 90)
14 cm, 5 1/2"



2666
O'BRIEN - (Fig. 97)
14 cm, 5 1/2"



2667
TWEED (Fig. 96)
14 cm, 5 1/2"

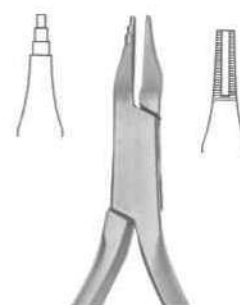

2668
TWEED (Fig. 95)
13.5 cm, 5 1/4"

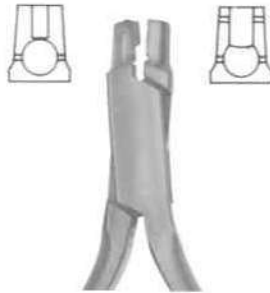

2669
SCHWARZ (Fig. 29)
12.5 cm, 5"



2670
NANCE (Fig. 80)
13 cm, 5 1/8"

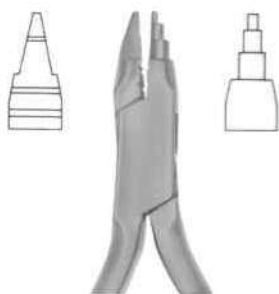

2671
YOUNG (Fig. 55)
13 cm, 5 1/8"



2672
SCHWARZ (Fig. 30)
13 cm, 5 1/8"

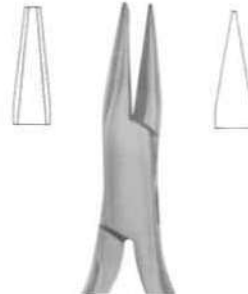

2673
Optical Plier (Fig. 53)
14 cm, 5 1/2"

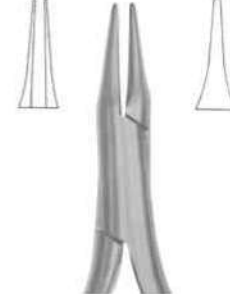

2674
Schwarz (Fig. 79)
13.5 cm, 5 1/4"



2675
NANCE (Fig. 56)
12.5 cm, 5"
Wire bending Pliers



2680
14.0 cm
Goslee Contouring Plier



2676
JOHNSON (Fig. 59)
13.5 cm, 5 1/4"
Contouring Plier.



2678
De La Rosa (Fig. 34)
12.5 cm, 5"
Contouring Plier, Non-Grooved

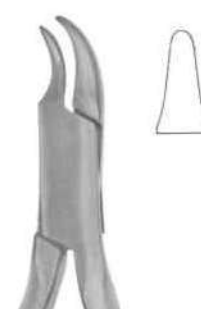

2677
REYNOLDS (Fig. 61)
13 cm, 5 1/8"
Contouring Plier.



2679
De La Rosa (Fig. 35)
12.5 cm, 5"
Contouring Plier, Grooved



2681
14.0 cm
Goslee Contouring Plier



2682



2683
Fig. 58
12.5 cm, 5"
Lingual Arch Bending Plier



2684
Frevert/Tweed (Fig. 51)
12.5 cm, 5"
Tweed Arch Plier/Standard Jaw

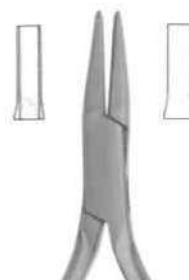

2685



2686
ANGLE (Fig. 52)
13 cm, 5 1/8"
Arch Forming Plier



2687
Fig. 60
13 cm, 5 1/8"
Wire & Clasp Bending Pliers



2688
Fig. 60
13 cm, 5 1/8"
Wire & Clasp Bending Pliers

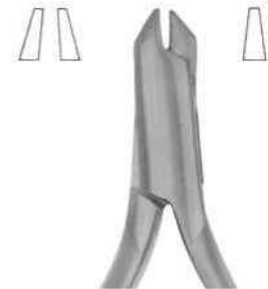

2689
Aderer (Fig. 57)
12 cm, 4 3/4"
Wire & Clasp Bending Pliers



2690
49 e 49 TC
14 cm, 5 1/2"
Band Removing Plier, short pad



2691
50 e 50 TC
14 cm, 5 1/2"
Band Removing Plier, long pad



2692
Fig. 84
14.5 cm, 5 3/4"
Band pinshing & ligature
locking plier, serrated



2693
Fig. 72
14 cm, 5 1/2"
Band pinshing & ligature
locking plier, serrated



2694
BRACKET (Fig. 82)
13.5 cm, 5 1/4"
Direct Bonding Bracket Remover



2695
BRACKET (Fig. 83)
13.5 cm, 5 1/4"
Direct Bonding
Bracket Remover



2696
38c, 38TC
13.5 cm, 5 1/4"
Contouring closing loop pliers,
wire bending, cutter.

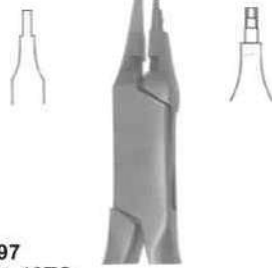

2697
40c, 40TC
13.5 cm, 5 1/4"
Contouring pliers light wire pliers
grooved with cutter.

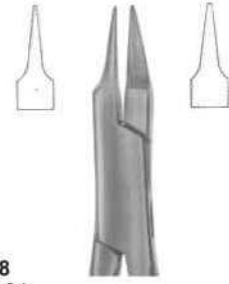

2698
Fig. 81
12.5 cm, 5"
Sling clasp & wire bending plier



2699
Fig. 28
14 cm, 5 1/2"
Sling clasp & wire bending plier.

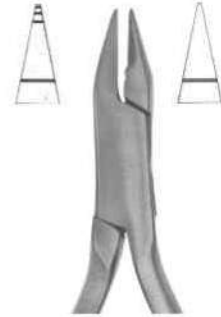

2700
Fig. 21
13 cm, 5 1/8"
Light wires pliers, grooved



2701
ADAMS, 23, 23TC
12.5 cm, 5"
Sling clasp & wire bending plier.



2702
ADAMS (Fig. 33)
12.5 cm, 5"
For retaining elements.



2703
ADAMS (Fig. 44)
12.5 cm, 5"
Sling clasp & wire bending plier.

2704
46c - 46 TC
ADAMS - N. 139c
12.5 cm, 5"
Bird beak with cutter.



2705
Universal Wire Bending
Pliers (ADAMS) 47 TC, N.64
12.5 cm, 5"
Sling clasp & wire bending plier.



2706
86c, 86 TC
Angle Bird Beak - N.138
12.5 cm, 5"
Sling clasp & wire bending plier.



2696
38c, 38TC
13.5 cm, 5 1/4"
Contouring closing loop pliers,
wire bending, cutter.

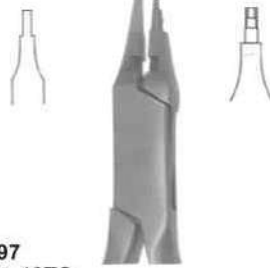

2697
40c, 40TC
13.5 cm, 5 1/4"
Contouring pliers light wire pliers
grooved with cutter.

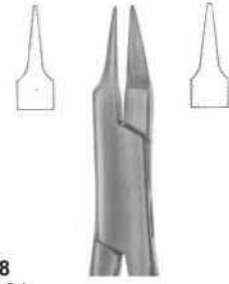

2698
Fig. 81
12.5 cm, 5"
Sling clasp & wire bending plier



2699
Fig. 28
14 cm, 5 1/2"
Sling clasp & wire bending plier.



2700
Fig. 21
13 cm, 5 1/8"
Light wires pliers, grooved



2701
ADAMS, 23, 23TC
12.5 cm, 5"
Sling clasp & wire bending plier.



2702
ADAMS (Fig. 33)
12.5 cm, 5"
For retaining elements.



2703
ADAMS (Fig. 44)
12.5 cm, 5"
Sling clasp & wire bending plier.

2704
46c - 46 TC
ADAMS - N. 139c
12.5 cm, 5"
Bird beak with cutter.



2705
Universal Wire Bending
Pliers (ADAMS) 47 TC, N.64
12.5 cm, 5"
Sling clasp & wire bending plier.



2706
86c, 86 TC
Angle Bird Beak - N.138
12.5 cm, 5"
Sling clasp & wire bending plier.



Ø 1.0 mm
(0.40")

2707
Fig. 18 TC
15 cm, 6"



Ø 1.0 mm
(0.40")

2708
Fig. 92 TC
14 cm, 5 1/2"



Ø 0.4 mm
(0.16")

2709
Fig. 91 TC
13 cm, 5 1/8"



Ø 0.4 mm
(0.16")

2710
Fig. 99 TC
13 cm, 5 1/8"



Ø 0.4 mm
(0.16")

2711
Fig. 94 TC
13 cm, 5 1/8"
Angled at 15° with or
without spring on \
the handles.



2712
Fig. 85 TC
13 cm, 5 1/8"



2713
Fig. 87 TC
13 cm, 5 1/8"



2714
Fig. 85 TC
Angled at 15°
13 cm, 5 1/8"



2715
ADAMS 87 TC
Angled at 15°
13 cm, 5 1/8"



Ø 1.0 mm
(0.40")

2707
Fig. 18 TC
15 cm, 6"



Ø 1.0 mm
(0.40")

2708
Fig. 92 TC
14 cm, 5 1/2"



Ø 0.4 mm
(0.16")

2709
Fig. 91 TC
13 cm, 5 1/8"



Ø 0.4 mm
(0.16")

2710
Fig. 99 TC
13 cm, 5 1/8"



Ø 0.4 mm
(0.16")

2711
Fig. 94 TC
13 cm, 5 1/8"
Angled at 15° with or
without spring on \
the handles.



2712
Fig. 85 TC
13 cm, 5 1/8"



2713
Fig. 87 TC
13 cm, 5 1/8"



2714
Fig. 85 TC
Angled at 15°
13 cm, 5 1/8"



2715
ADAMS 87 TC
Angled at 15°
13 cm, 5 1/8"

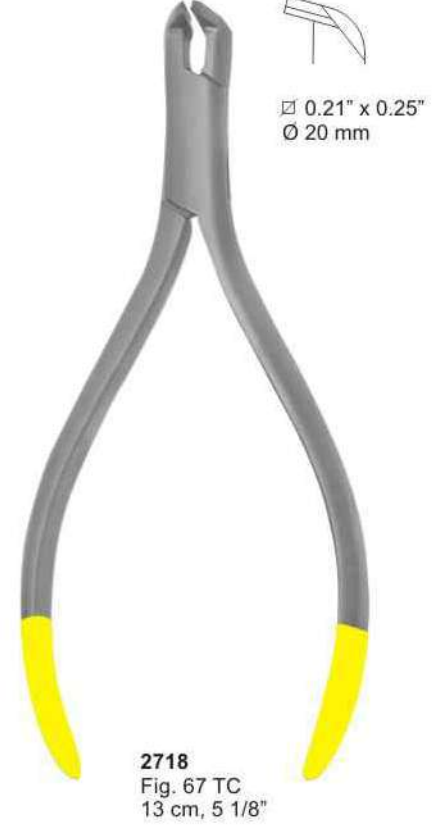
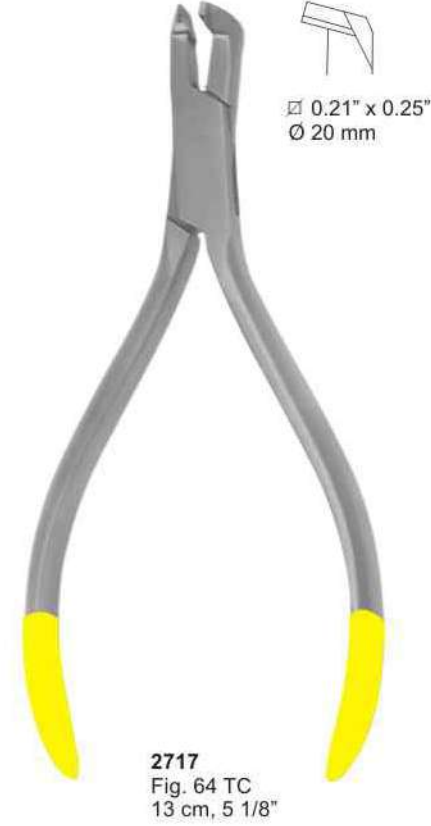
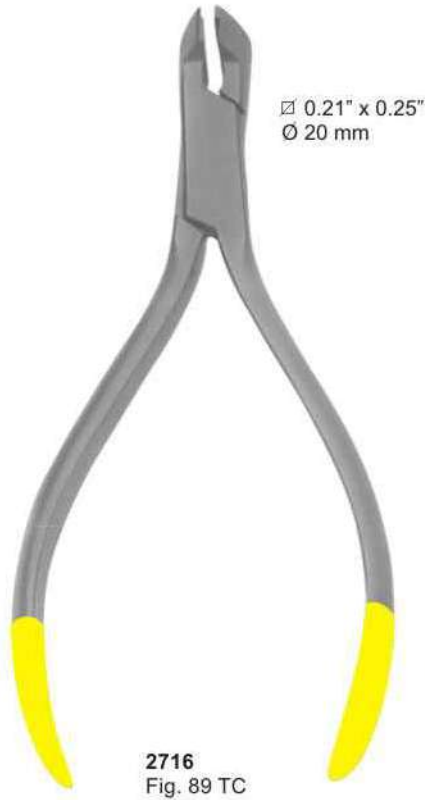



2721
UNIVERSAL
150 mm

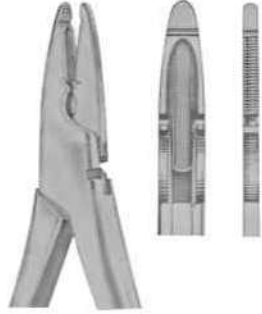

2722
WALDSACHS
155 mm



2723
ADERER
125 mm

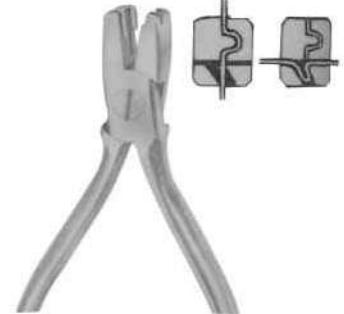

2724
NANCE
125 mm

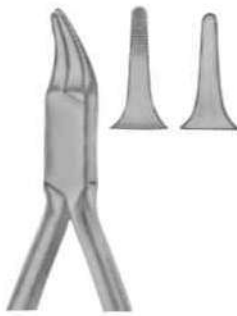

2725
REYNOLDS
125 mm



2726
HOW
145 mm



2727
HOW
140 mm



2731
FURRER
150 mm



2728
WALDRON
125 mm

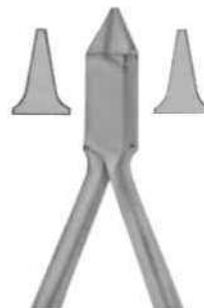

2729
ADAMS
125 mm

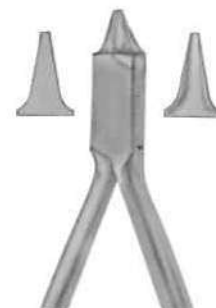

2730
ANGLE
125 mm

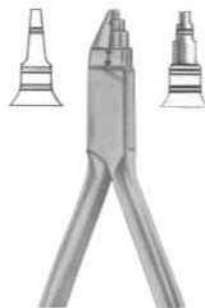

2732
YOUNG
130 mm

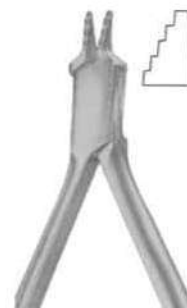

2733
NANCE
130 mm



2734
LANGEBECK
125 mm



2735
LANGEBECK
140 mm



2736
LANGEBECK
130 mm

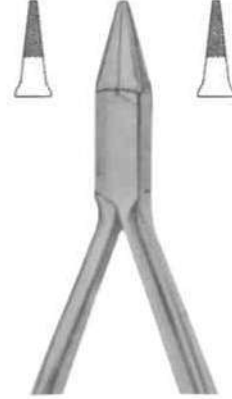

2737
PEESO
125 mm



2738
GOSLEE
125 mm

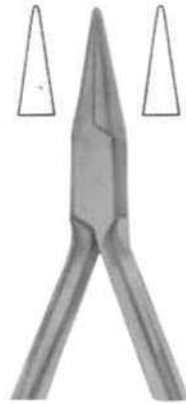

2739
FISCHER
140 mm



2740
FISCHER
140 mm



2741
JOHNSON
130 mm



2742
MSY
130 mm



2743
MC KELLOPS
155 mm



2744
ANDRESEN
130 mm

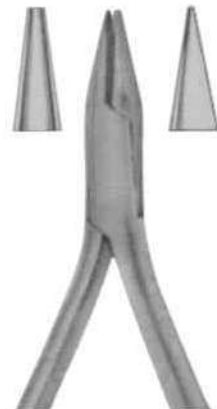

2745
SCHWARZ
130 mm



2746
BLUMENTHAL
6", 30°, Standard

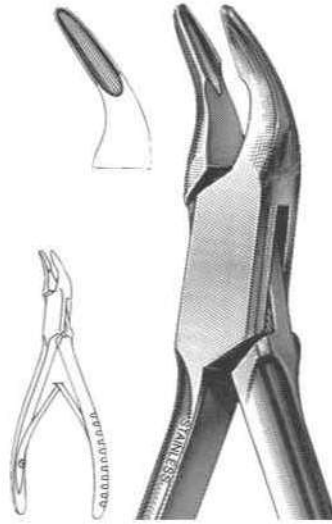

2747
MINI-BLUMENTHAL
6", 45°

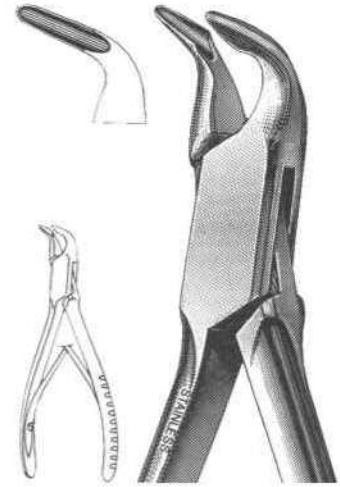

2748
MINI-BLUMENTHAL
6", 90°

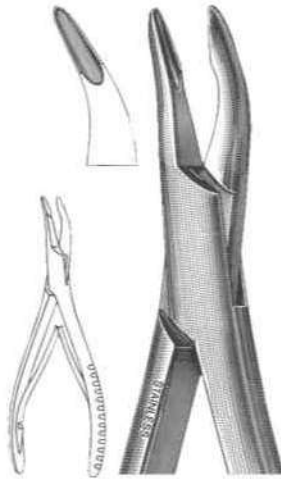

2749
BLUMENTHAL
7", 30°

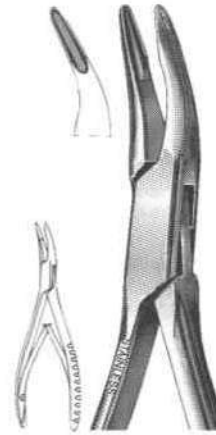

2750
MINI-BLUMENTHAL
4 1/2", 30°

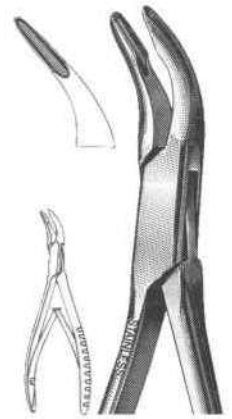

2751
MINI-BLUMENTHAL
4 1/2", 45°



2752
CLEVELAND
No. 5-Side Cutting,
6 3/4"

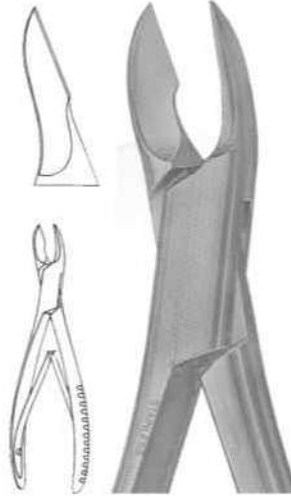

2753
CLEVELAND
No. 5A-Side Cutting,
6 1/2"

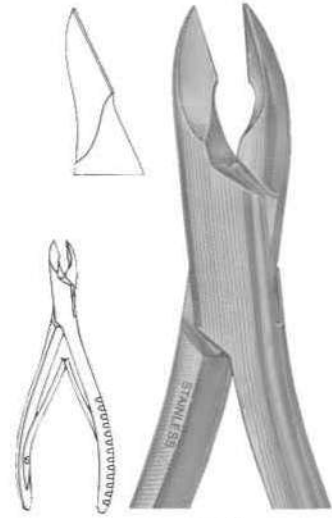

2754
CLEVELAND
No. 5S-Side Cutting,
6"

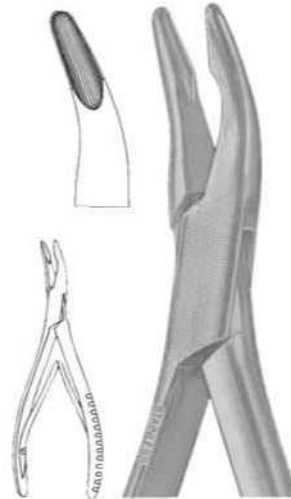

2755
No. 1A-MEAD
6 1/2"

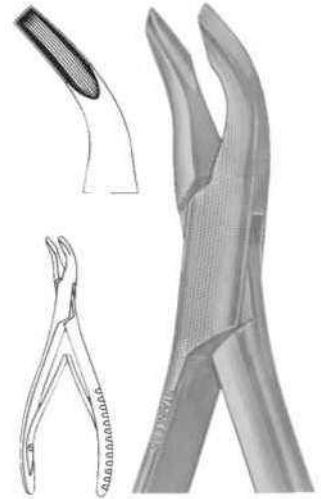

2756
MEAD, Square
No. 2A
Tips, 6 1/2"

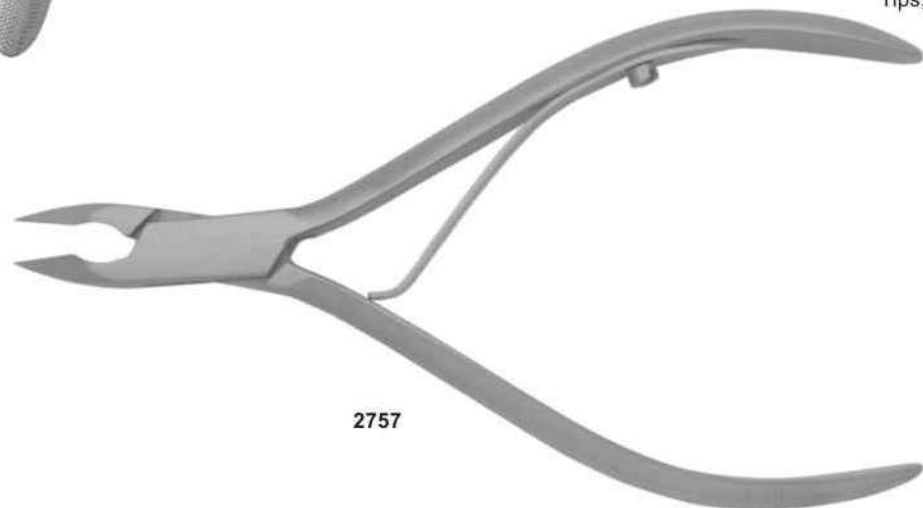

2757



2757
FRIEDMAN
5 ½"

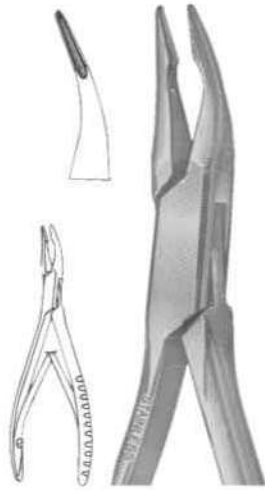

2758
MICRO-FRIEDMAN
5 ½", 15° Curved Jaws

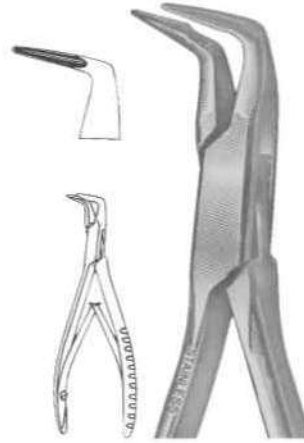

2759
MICRO-FRIEDMAN
Perio Rongeur, 5 ½"

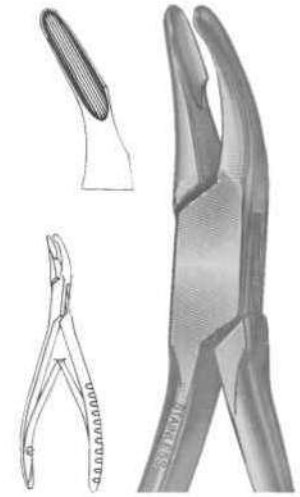

2760
CLEVELAND
No. 4 - 5 ½"

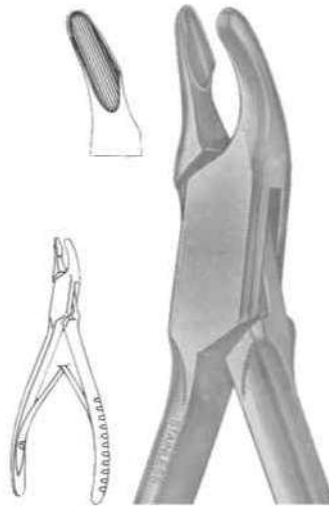

2761
CLEVELAND
No. 4A - 6 ½"

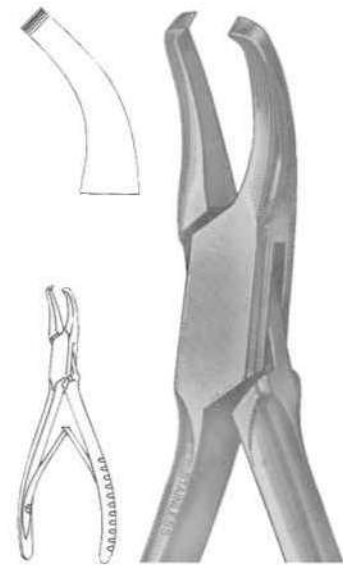

2762
GARDNER
No. 6A, End Cutting
6 ½"



2763
BEYER
Double Action,
16,18 cm



2764
No. 1
6 1/2"

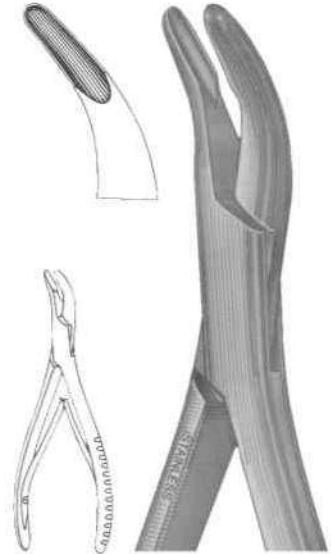

2765
HARTMAN
5 3/4"
Strong Curve

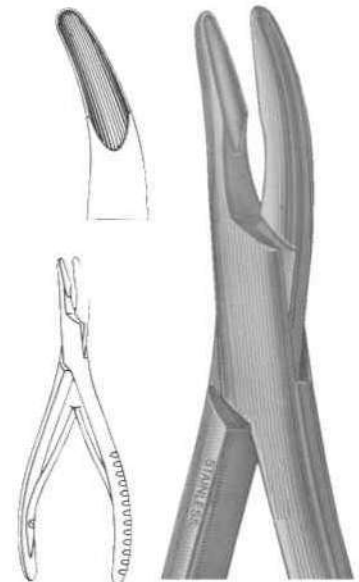

2766
BANE
Slight Curve
7"



2767
COLLIER
5", Fenestrated Jaws



2768
DERF
4 3/4"



2769
WEBSTER
Delicate Smooth Jaws
5"



2770
NEIVERT
One Offset Ring
5"



2771
OLSEN-HEGAR
5 1/2"



2772
BAUMGARTNER
5 1/2"



2773
CRILE-WOOD
6"



2774
GARDNER
5"

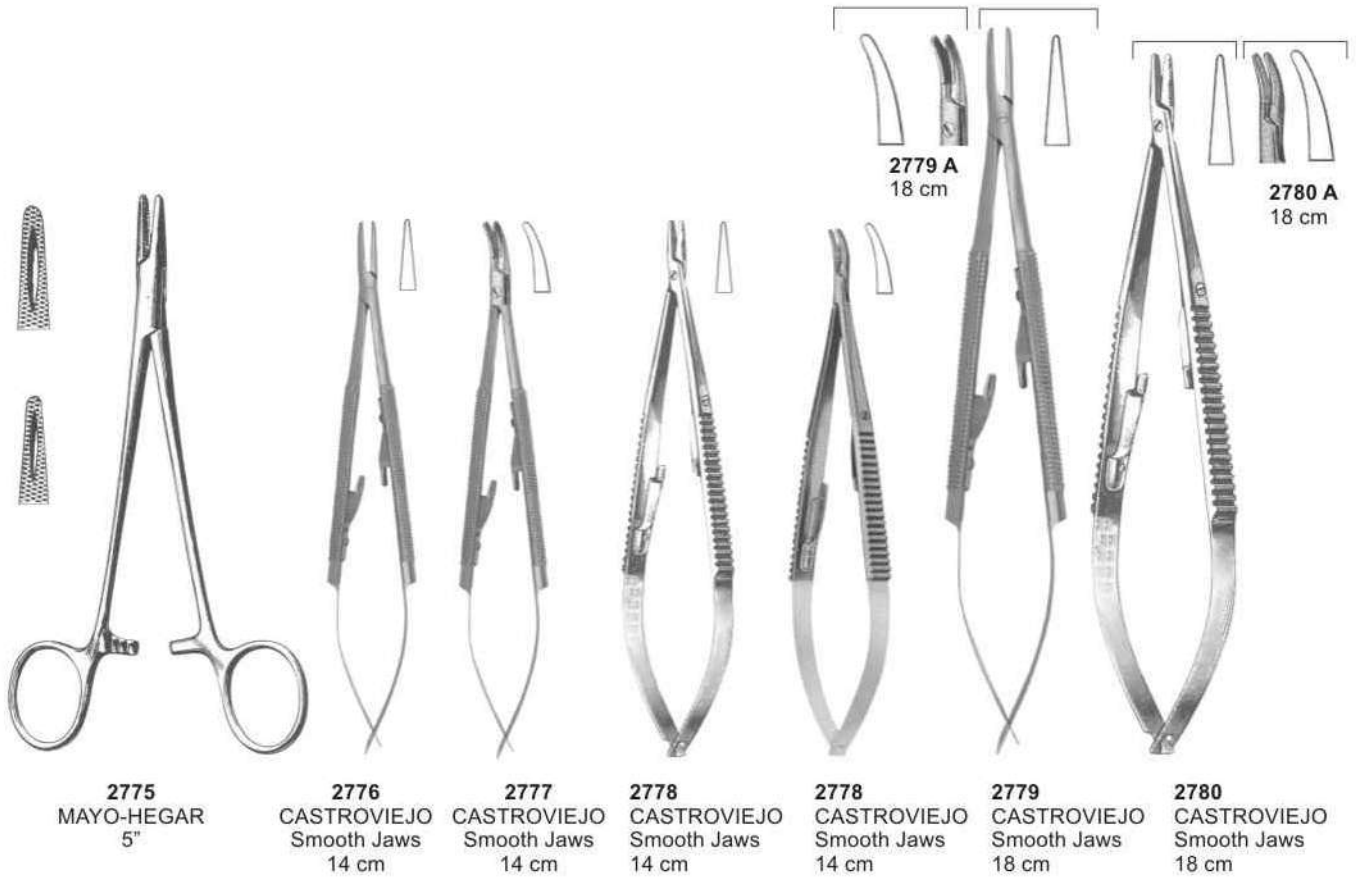

2775
MAYO-HEGAR
5"

2776
CASTROVIEJO
Smooth Jaws
14 cm

2777
CASTROVIEJO
Smooth Jaws
14 cm

2778
CASTROVIEJO
Smooth Jaws
14 cm

2778
CASTROVIEJO
Smooth Jaws
14 cm

2779
CASTROVIEJO
Smooth Jaws
18 cm

2780
CASTROVIEJO
Smooth Jaws
18 cm

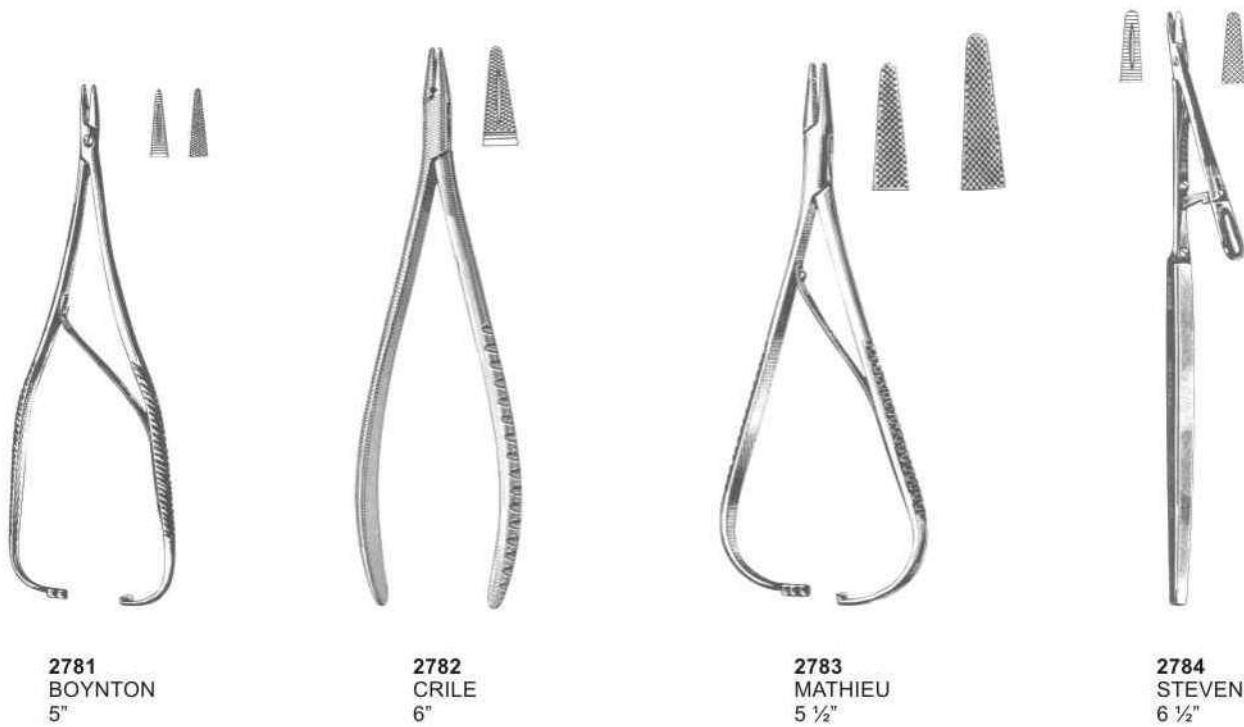

2781
BOYNTON
5"

2782
CRILE
6"

2783
MATHIEU
5 ½"

2784
STEVENS
6 ½"



2785
Micro Scissor
Straight, 155 mm



2786
Micro Scissor
Straight, 150 mm



2787
Micro Scissor
Curved, 150 mm



2788
Micro Scissor
Curved, 155 mm



2789
CASTROVIEJO
T.C.
Straight, 180 mm



2790
Retractor
Fig.3
165 mm



2791
Micro Adson
120 mm



2792
GERALD
Curved,
180 mm



2793
GERALD
Straight,
175 mm



2794
Micro Adson
160 mm

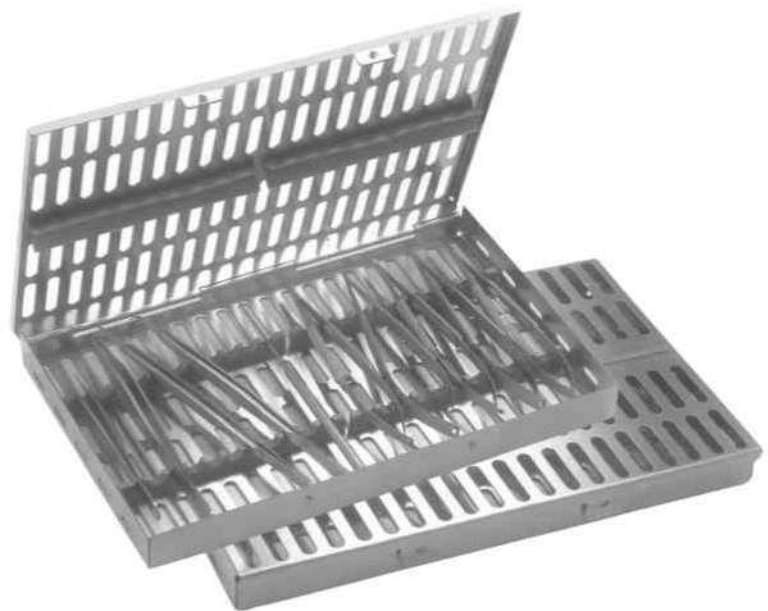

2795
Micro Surgery Set 10 Pieces.

- ✦ Scissors
- ✦ Impression Trays
- ✦ Articulators
- ✦ Hollow Wares
- ✦ T.C. Instruments



08

SECTION



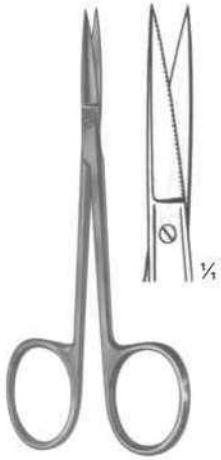

2796
IRIS (Standard)
Straight
11.5 cm, 4 1/2"

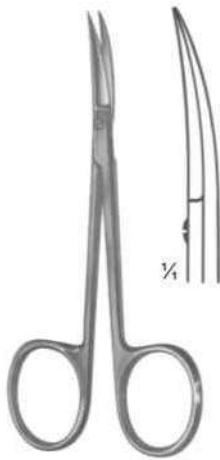

2797
IRIS (Standard)
Curved
11.5 cm, 4 1/2"



2798
STEVENS
Dissecting Scissors
Size: 115 mm



2799
Sharp



2800
Sharp



2801
Blunt



2802
Blunt



2803



2804
JOSEPH
Size: 150 mm

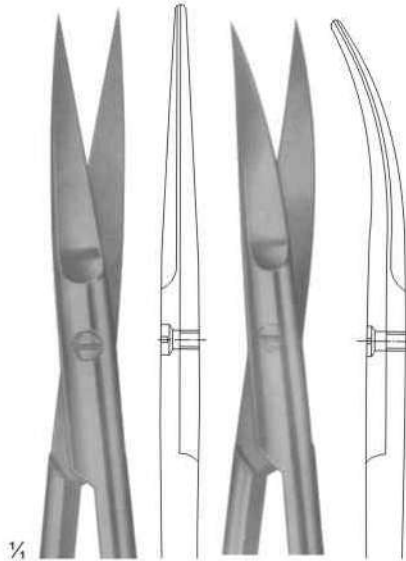

2805

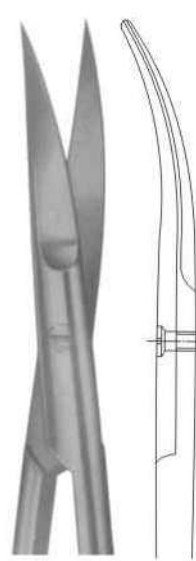

2806

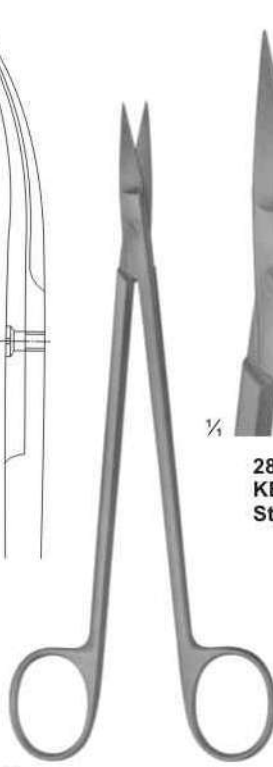

2807
KELLY
Size: 175 mm

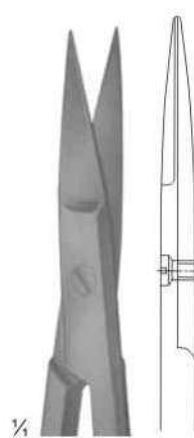

2808
KELLY
Straight

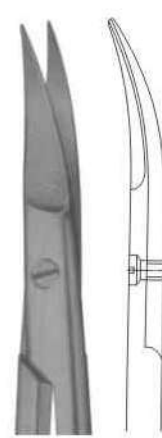

2809
KELLY
Curved

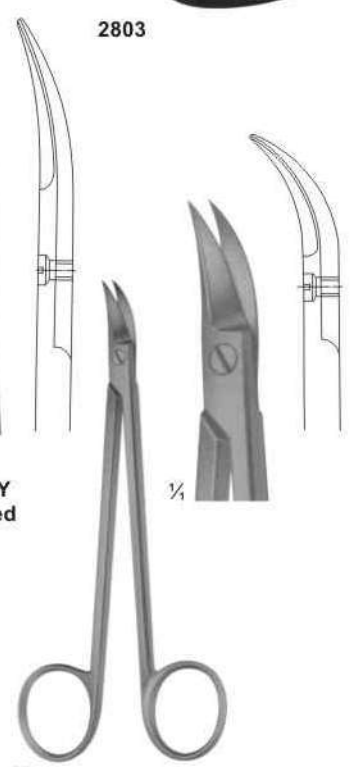

2810
QUINBY
Size: 130 mm

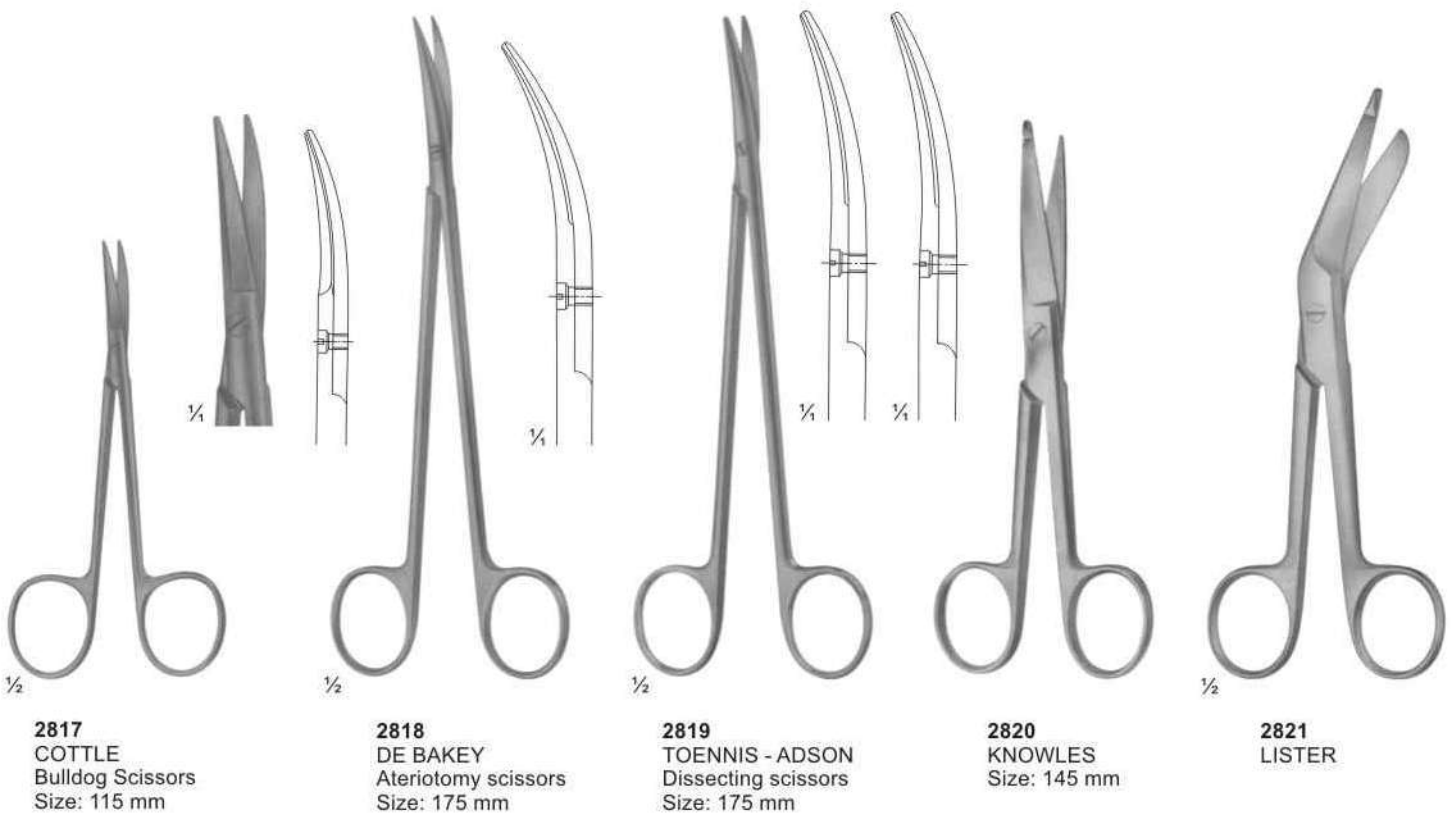
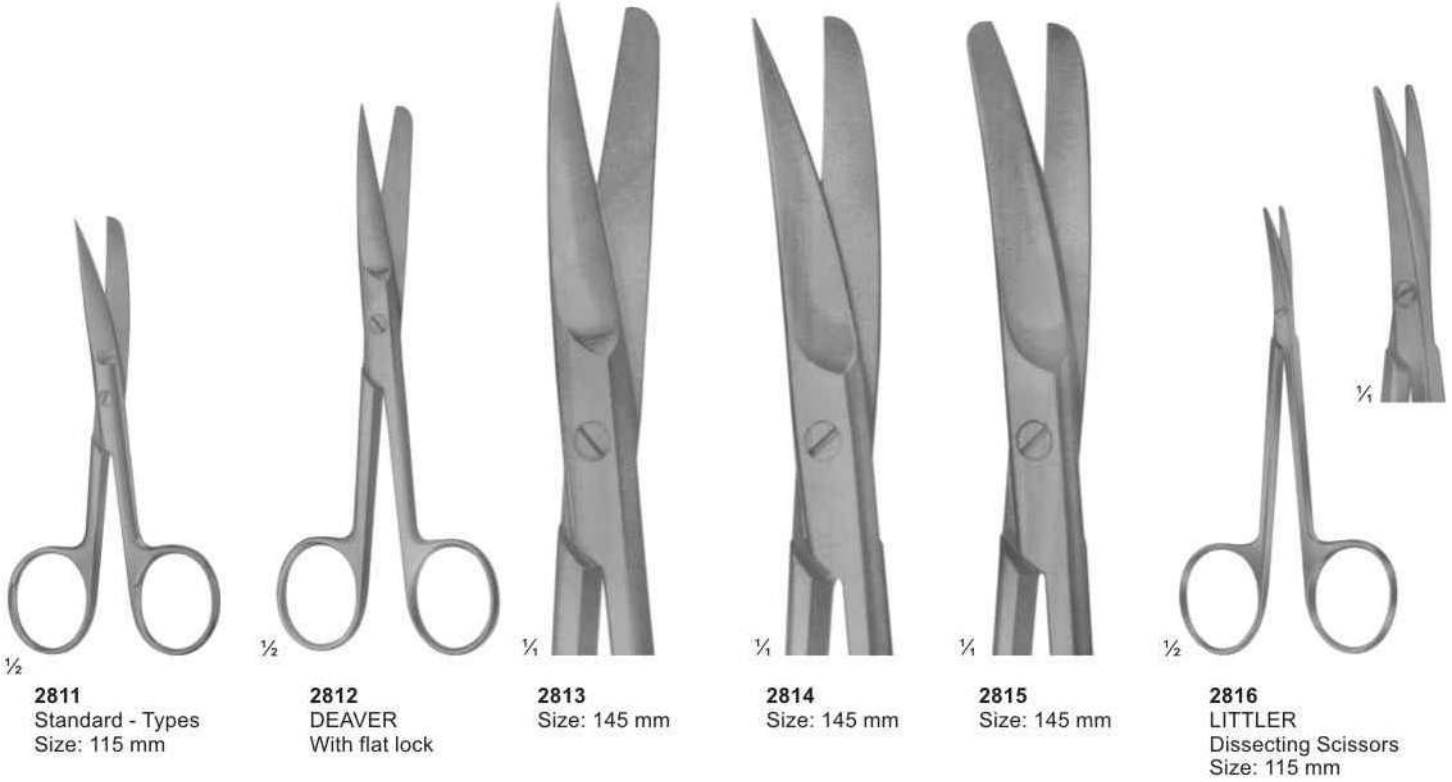

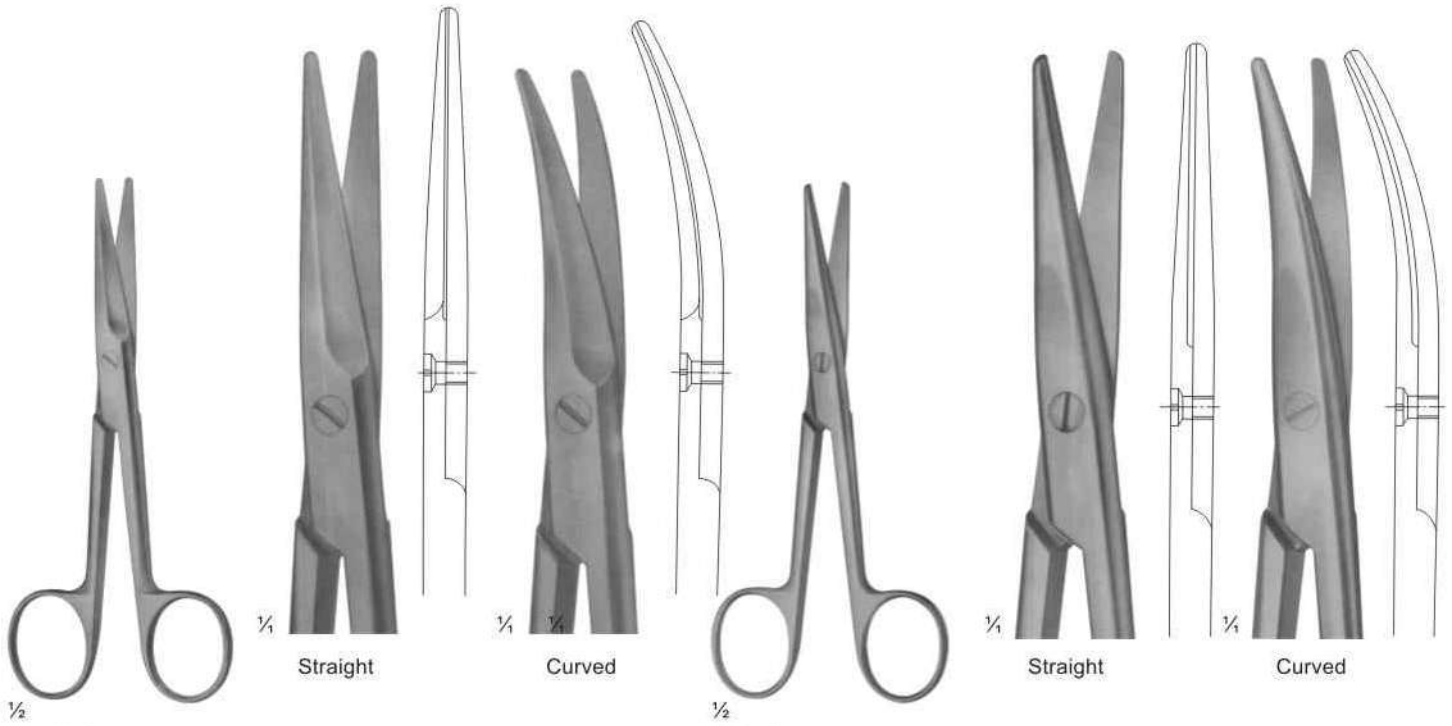

2822
MAYO (straight)
Size: 140 mm

2823
MAYO-STILLE (straight)
Size: 140 mm

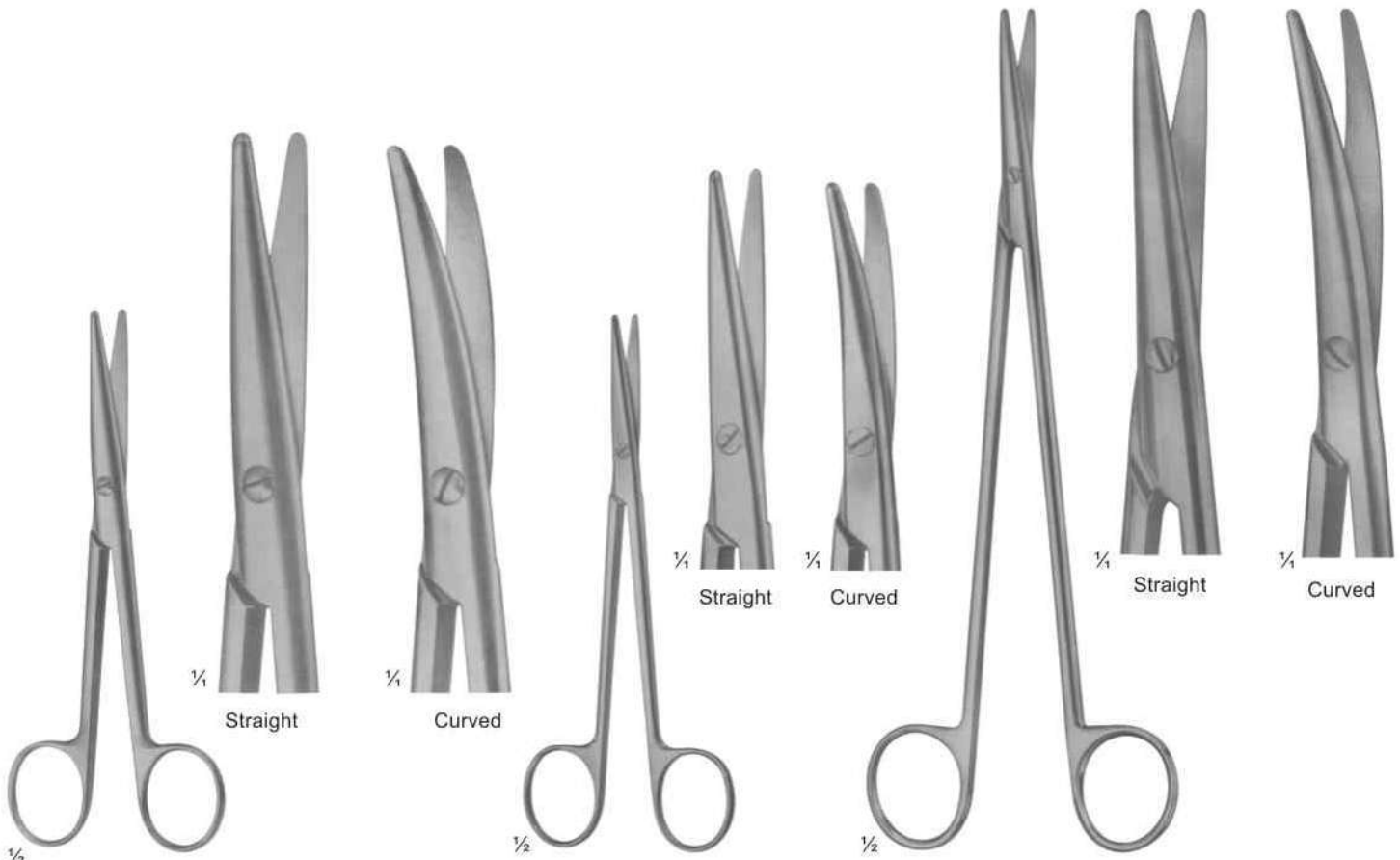

2824
STILLE
Size: 140 mm

2825
METZENBAUM
Size: 145 mm

2826
NELSON-METZENBAUM
Size: 230 mm

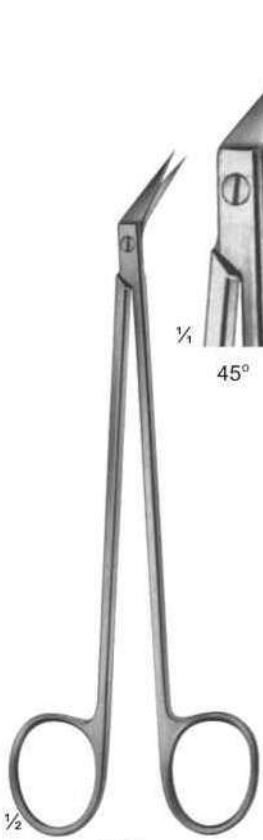

2827
DE BAKEY
Size: 155 mm

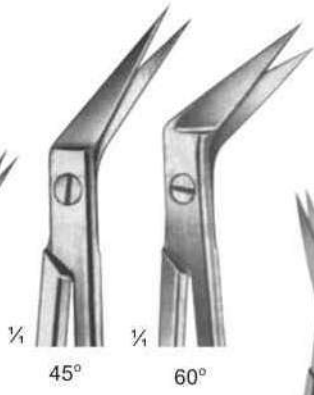

2828
LOCKLIN
Curved Sideways,
1 Toothed Blade
Size: 155 mm



2829
LaGrange
Double-Curved
11.5 cm



2830
Goldman-Fox
Double-Curved
13cm



2831
SPENCER
Size: 90 mm

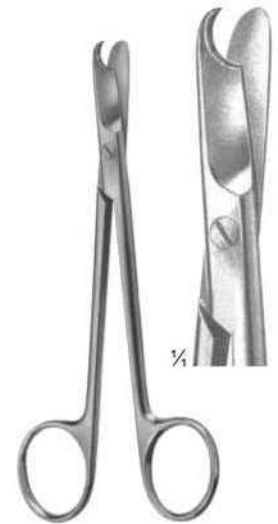

2832
LITTAUER
Size: 135 mm



2833
BEEBE
Size: 110 mm



2834

2835

2836

2837



2838
Dean
17cm

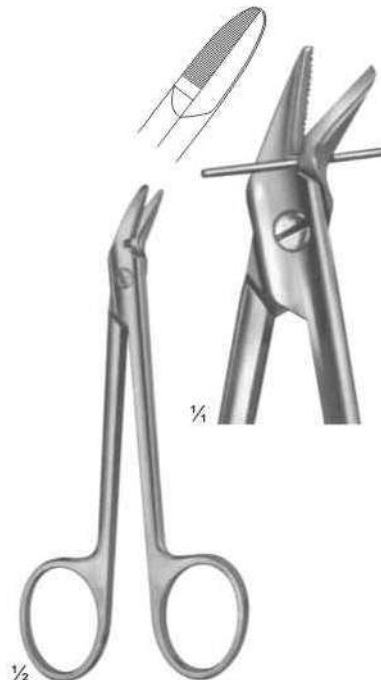

2839
1 Blade Serrated
Size: 120 mm

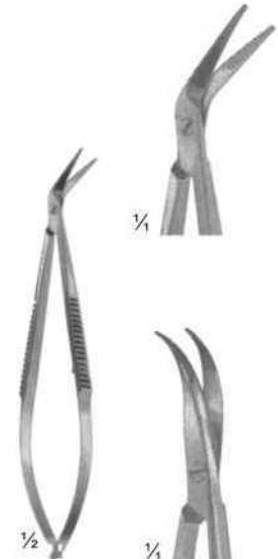

2840
CASTROVIEJO
Size: 90 mm

Made of 18/8 Stainless Steel, Solid, Set of 10

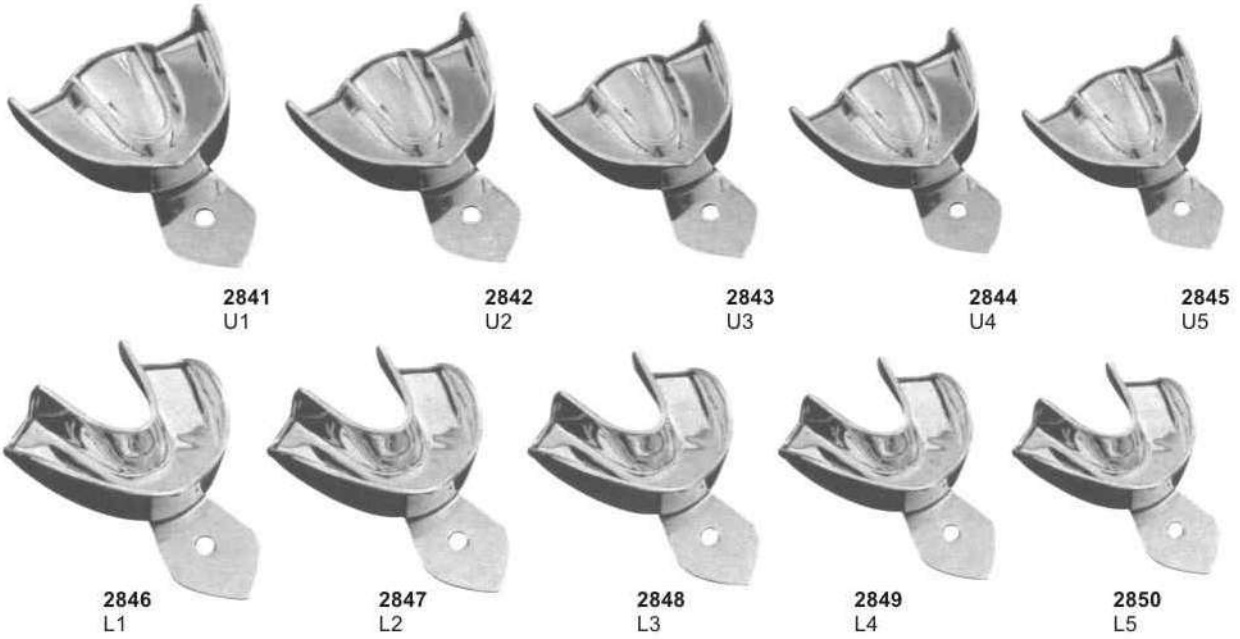

All The Above Impression Trays are Available in These 5 Sizes

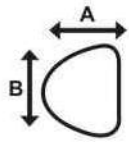

UPPER		U1	U2	U3	U4	U5
	A	62	60	53	54	52
B	83	75	73	69	68	

All Dimension are in mm

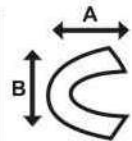

LOWER		L1	L2	L3	L4	L5
	A	63	61	57	60	53
B	82	81	78	74	71	

All Dimension are in mm

Perforated, Set of 10

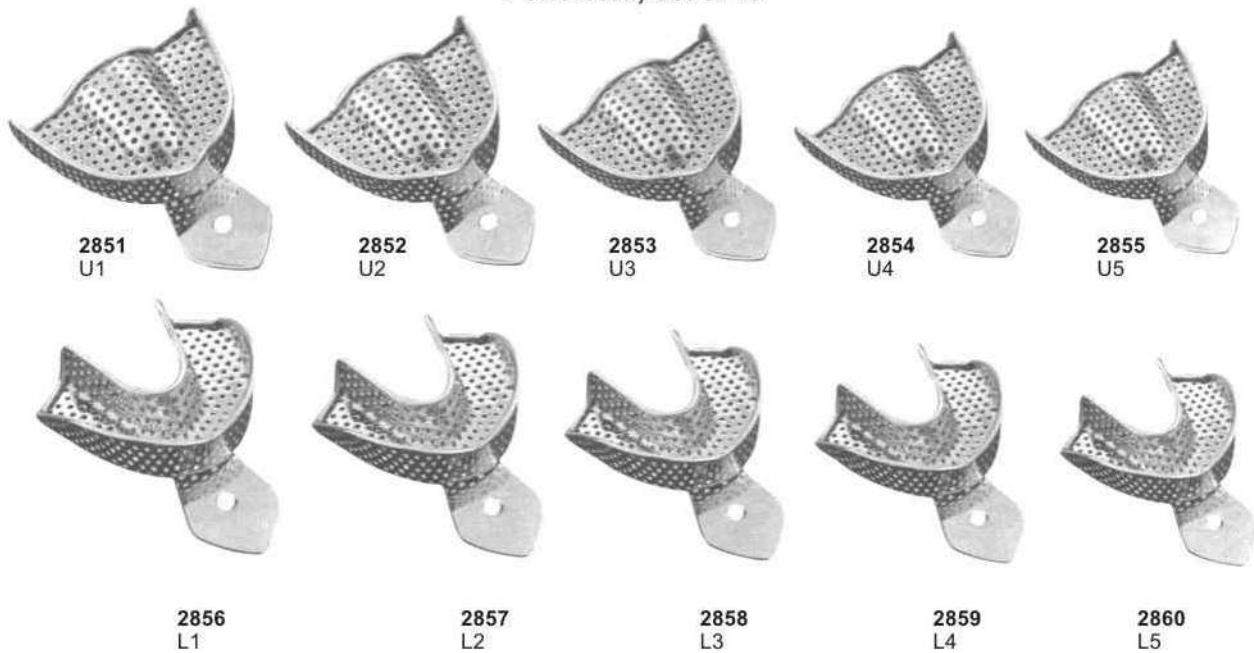

Made of 18/8 Stainless Steel, Solid Full Denture Set of 8

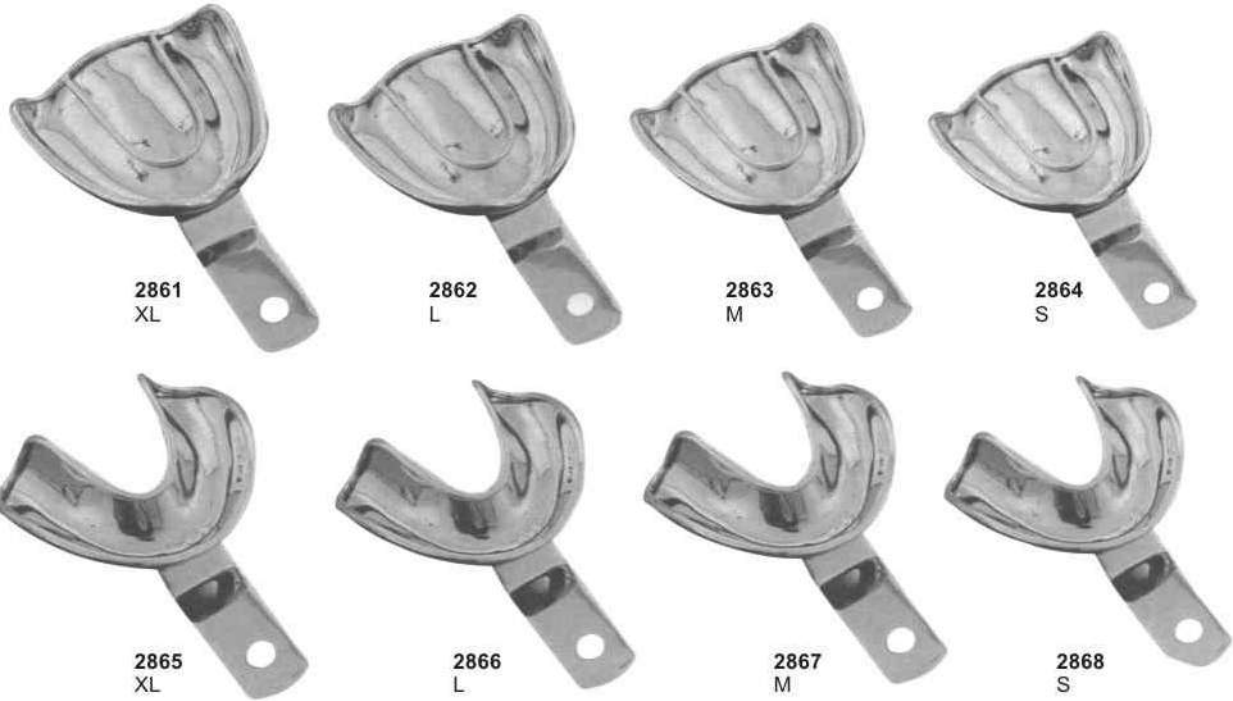

All The Above Impression Trays are Available in These 4 Sizes

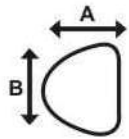

UPPER		XL	L	M	S
	A	70	67	64	60
B	79	76	70	73	

All Dimension are in mm

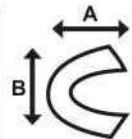

LOWER		XL	L	M	S
	A	64	64	60	57
B	86	70	73	70	

All Dimension are in mm

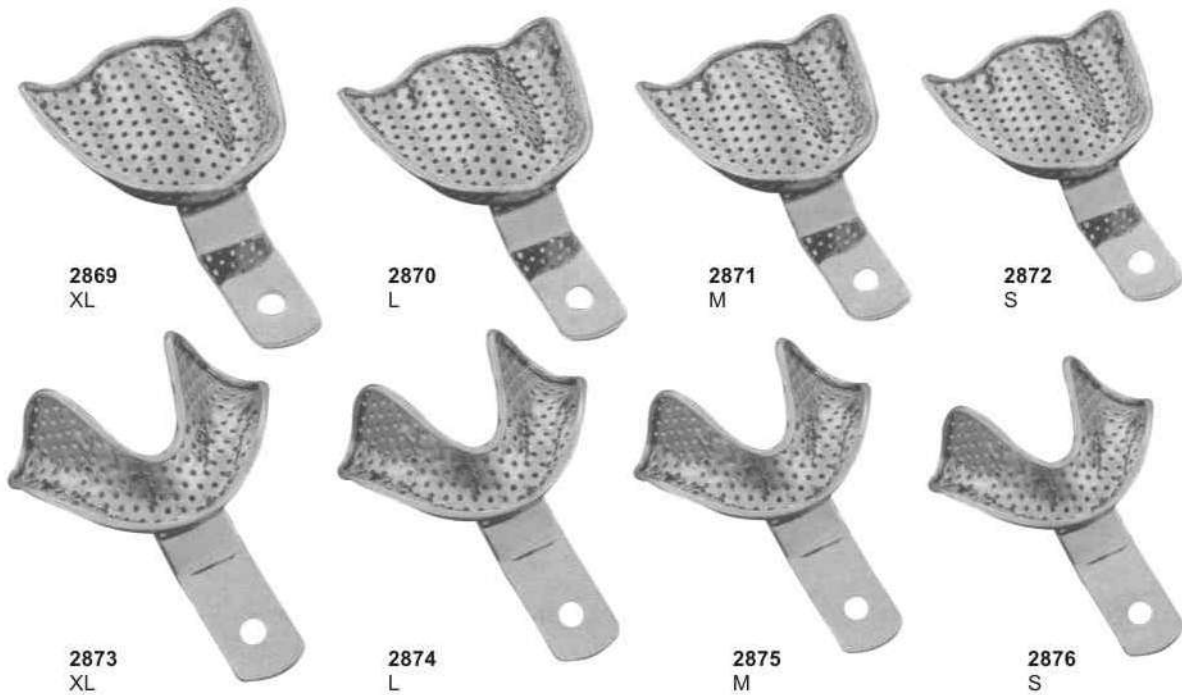

Perforated Full Denture Set of 8

Made of 18/8 Stainless Steel, Solid Set of 6

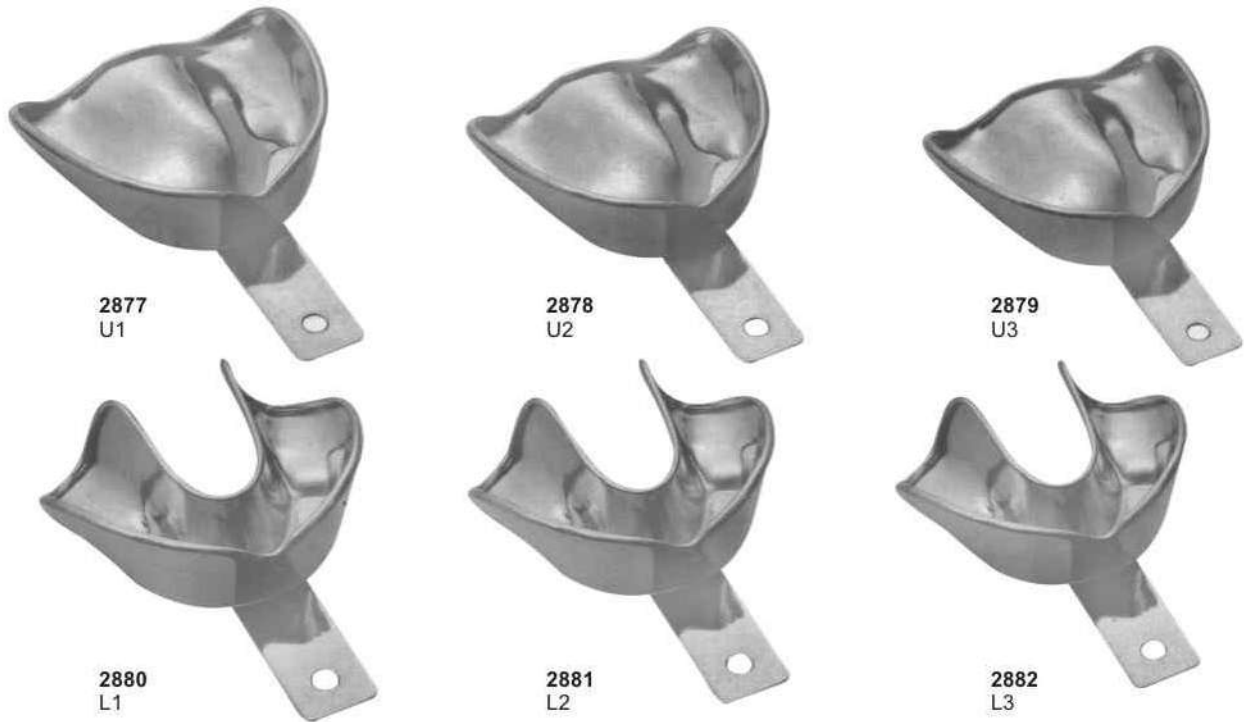

2877
U1

2878
U2

2879
U3

2880
L1

2881
L2

2882
L3

All The Above Impression Trays are Available in These 4 Sizes

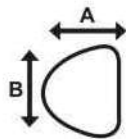

UPPER		U1	U2	U3
	A	67	64	57
B	81	71	70	

All Dimension are in mm

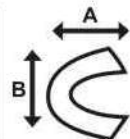

LOWER		L1	L2	L3
	A	60	57	54
B	81	79	76	

All Dimension are in mm

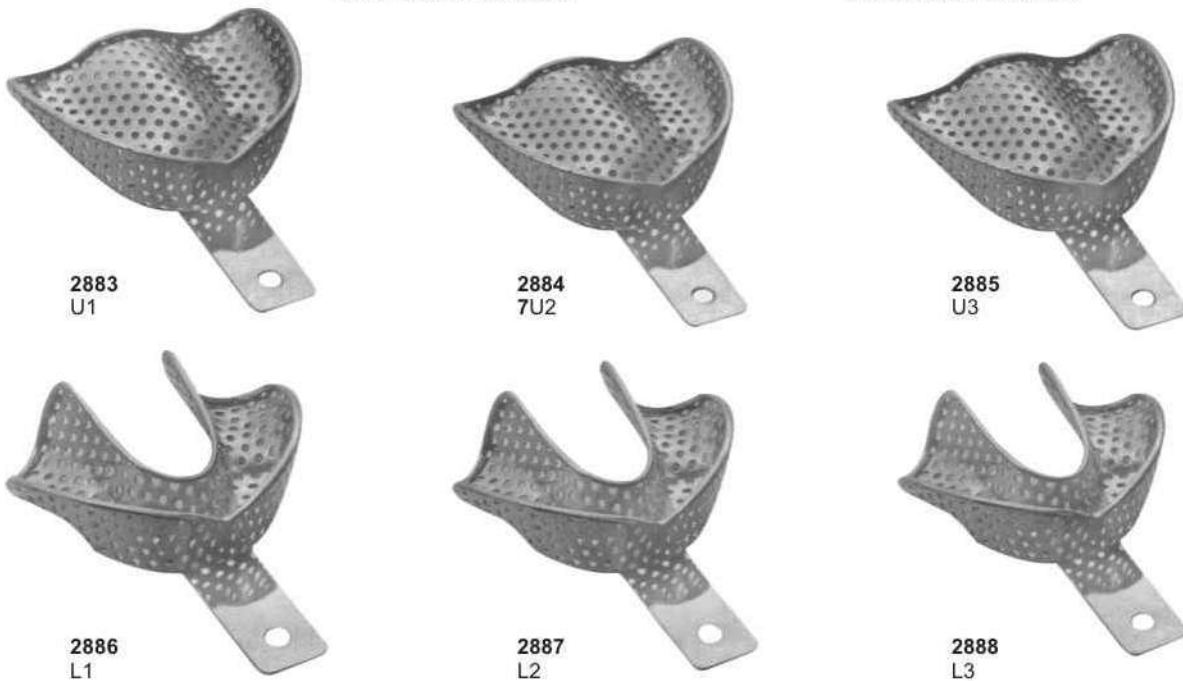

2883
U1

2884
U2

2885
U3

2886
L1

2887
L2

2888
L3

Perforated Set of 6

Made of 18/8 Stainless Steel, English Pattern Set of 8



2889
Lower



2890
Upper



2891
Lower



2892
Upper



2893
Lower



2894
Upper

All The Above Impression Trays are Available in These 4 Sizes

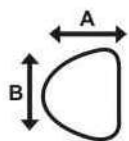

UPPER	Size	A	B	C
	0	67	50	12
	1	72	51	13
	2	78	55	15
	3	80	58	15

All Dimension are in mm

LOWER	Size	A	B	C
	0	70	50	14
	1	77	51	15
	2	79	55	15
	3	80	60	17

All Dimension are in mm

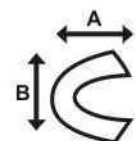

Made of 18/8 Stainless Steel, Solid Full Denture Set of 8

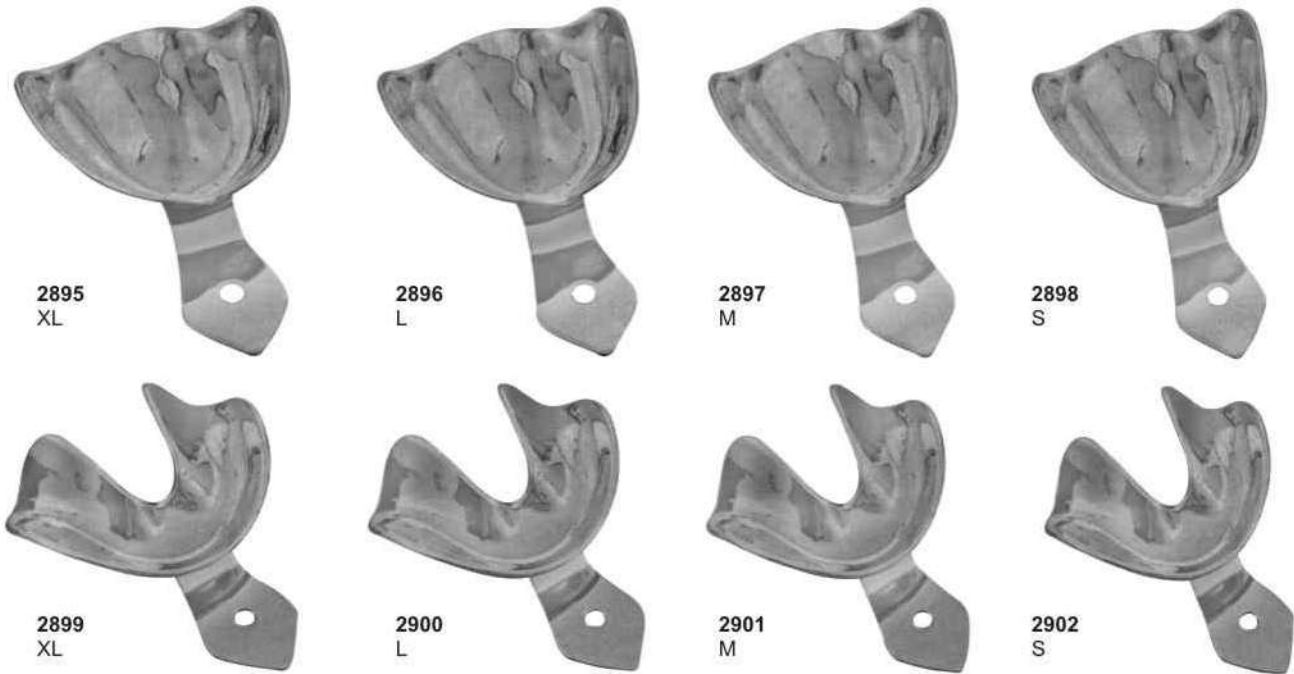

All The Above Impression Trays are Available in These 4 Sizes

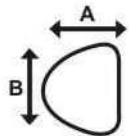

UPPER		XL	L	M	S
	A	70	67	64	60
B	79	76	70	73	

All Dimension are in mm

LOWER		XL	L	M	S
	A	64	64	60	57
B	86	70	73	70	

All Dimension are in mm

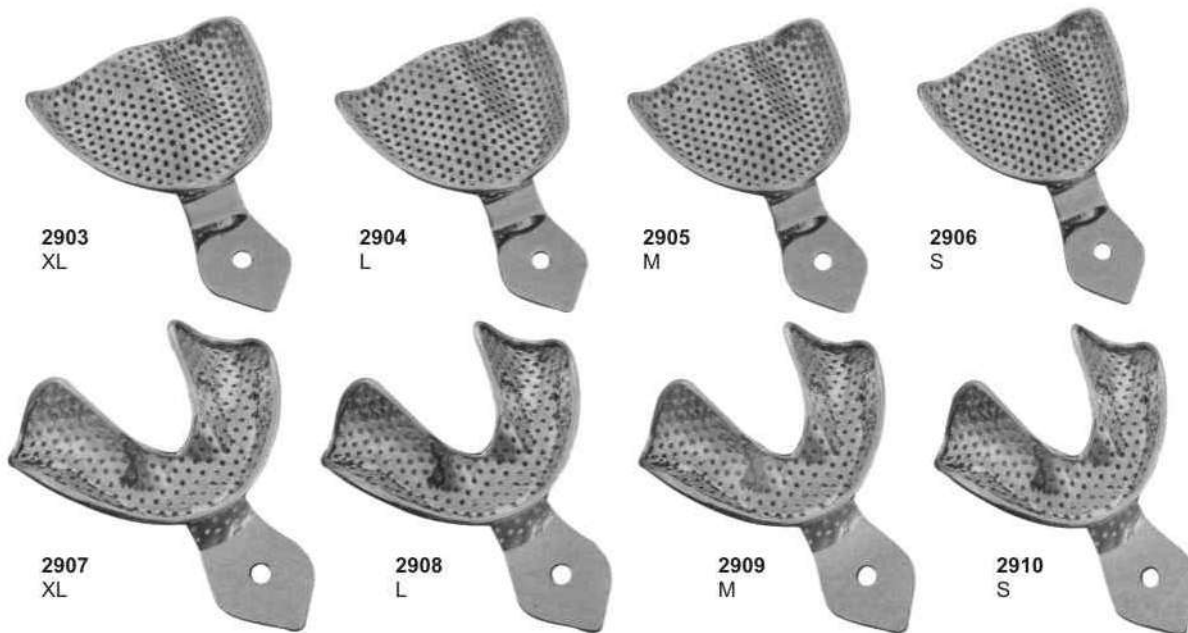

Made of 18/8 Stainless Steel, Perforated Full Denture Set of 8

Made of 18/8 Stainless Steel, Solid Full Denture Set of 8

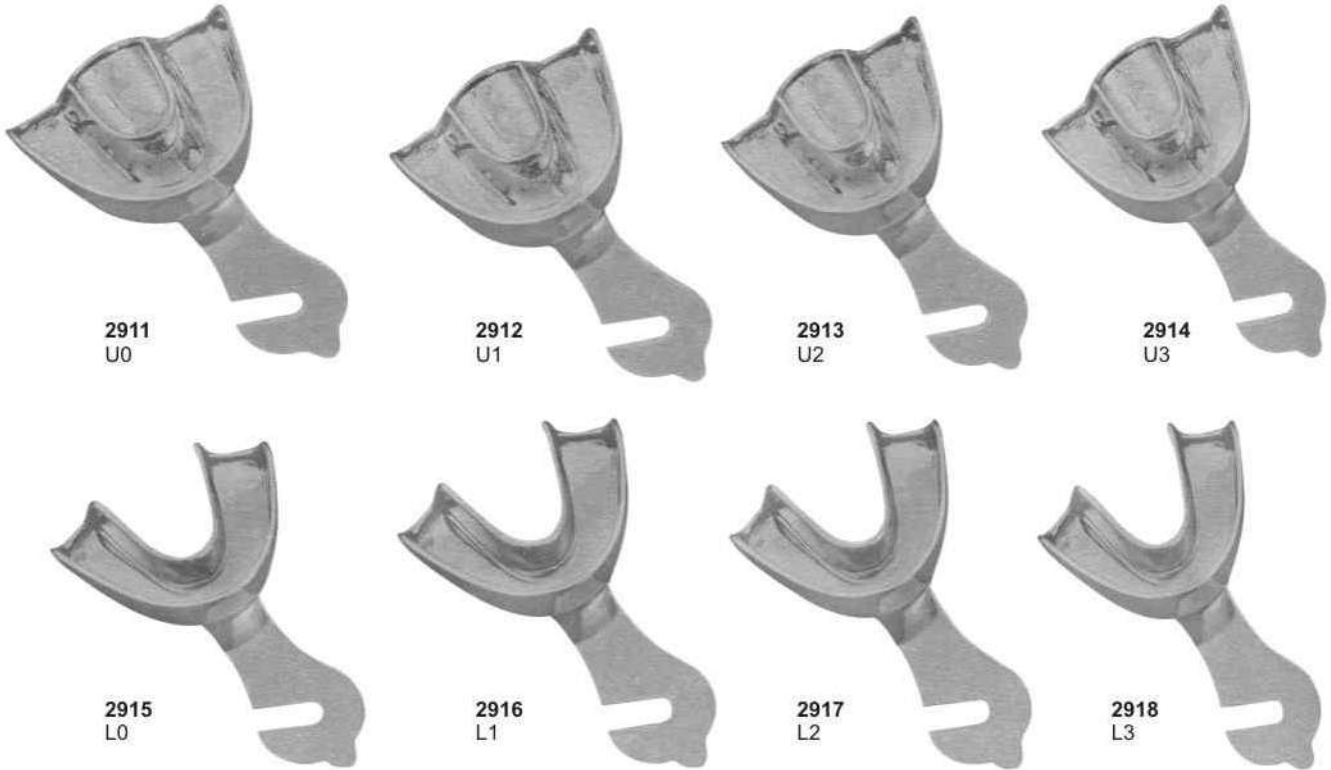

Upper Sizes: 0,1,2,3

Depth of Tray: 15,9 mm, Height of Plate: 12,5 mm

Lower Sizes: 0,1,2,3

Depth of Tray: 12,9 mm

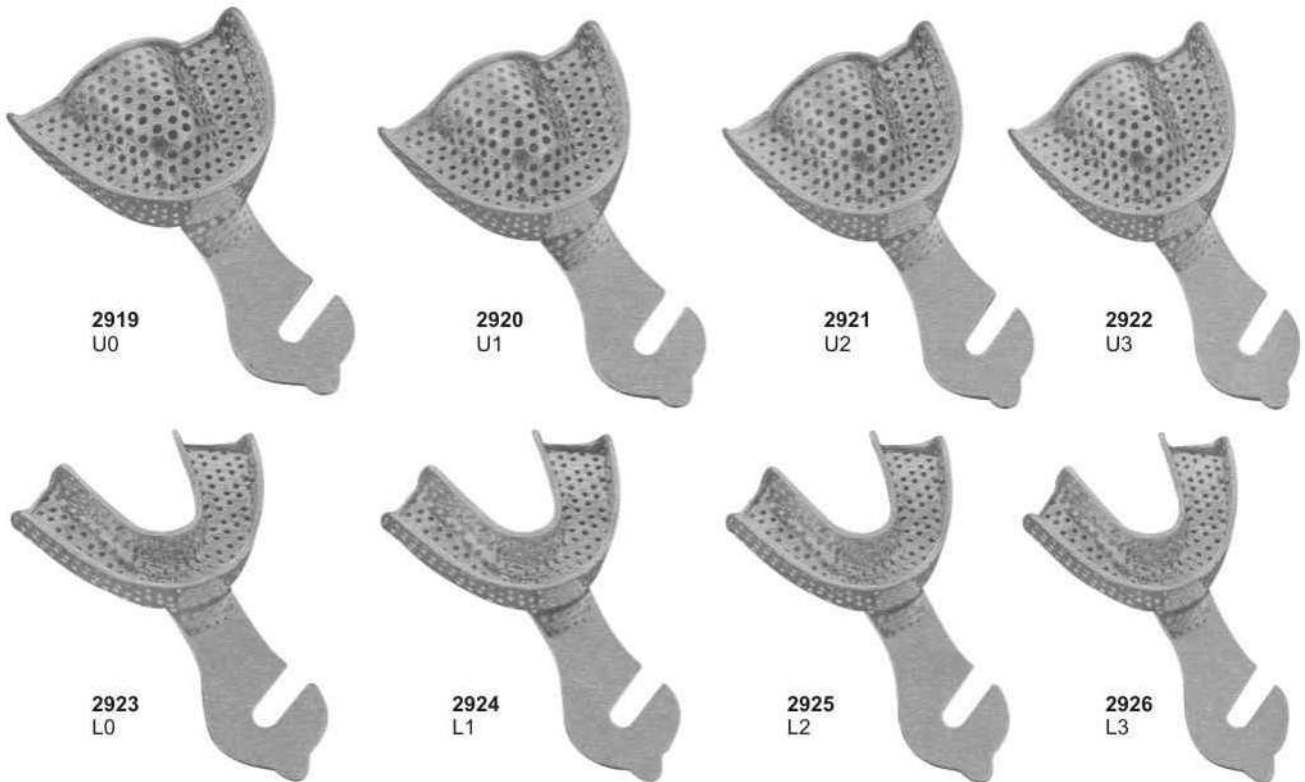

Made of 18/8 Stainless Steel, Perforated Full Denture Set of 8

Impression Trays For Crown & Bridge Work

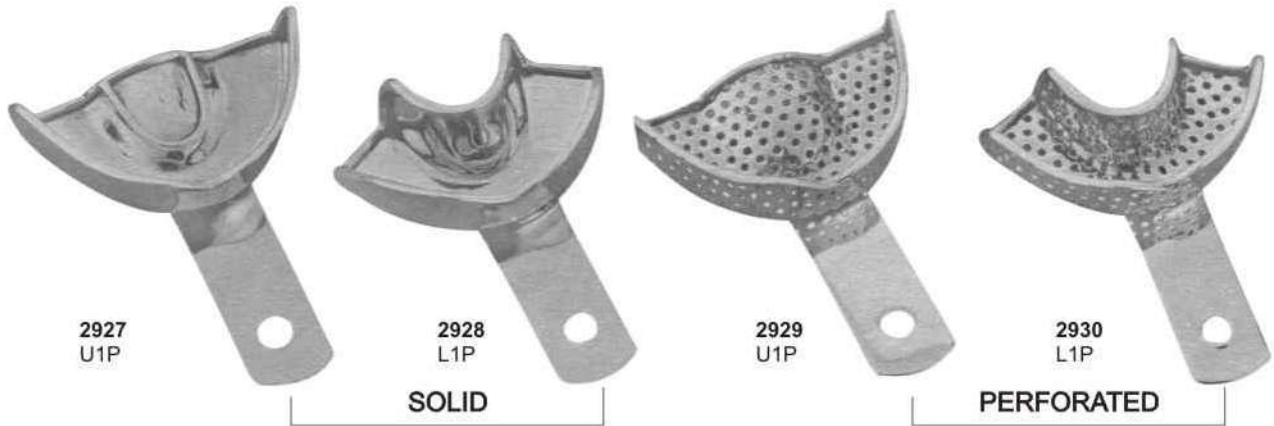

PERFORATED

SOLID



2931-A
For upper right jaw
For lower left jaw

2931-B
For upper left jaw
For lower right jaw



2931-C
For upper right jaw
For lower left jaw

2931-D
For upper left jaw
For lower right jaw

Available in 4 sizes

- 1.....44 mm
- 2.....55 mm
- 3.....60 mm
- 4.....65 mm

Available in 4 sizes

- 1.....44 mm
- 2.....55 mm
- 3.....60 mm
- 4.....65 mm



2934



2935



2936



2937



2939



2938



2940



2941



2942



2943



2944



2945



2946



2947



2948
Instruments Tray of 20 Pcs

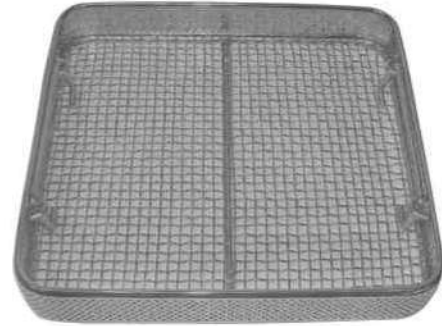

2951
Instruments Riddle



2949
Instruments Tray of 7 Pcs



2949-A
Instruments Tray of 10 Pcs



2950
Instruments Tray of 5 Pcs

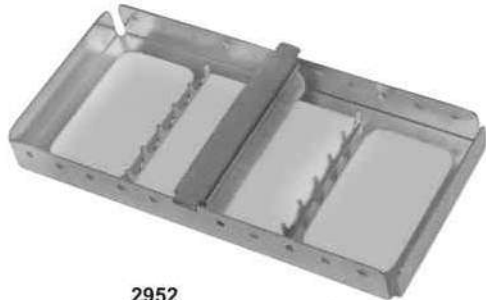

2952
Instruments Tray of 5 Pcs

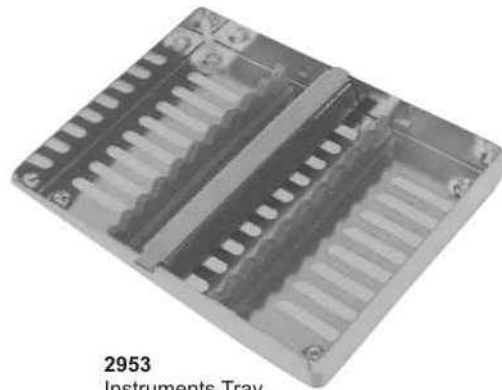

2953
Instruments Tray



2954
Instruments Tray
Perforated



2955
Instruments Tray
Perforated Base



2956
Instruments Tray
Solid Base



2957
Pulpectomy Tray



2958
Sterilizing Box
Available Sizes:
17x17x3 cm
20x10x6 cm
30x14x6 cm



2959
Endo Tray Box



2960
Finger Cup



2961
Bur Box

2962
Sterilizing Drum
150x150mm
175x175mm
190x190mm
200x140mm
200x200mm
240x120mm
225x225mm
240x240mm
290x160mm



2963
Sterilizing Drum
280x240mm
230x150mm
300x250mm
340x160mm
350x250mm
390x200mm
380x300mm
100x100mm
150x120mm



2964
Instruments Box



2965
Instruments Box



2966
Instruments Box



2967
Instruments Sterilizer
150x75 mm



2968
Endodontic Box



2969
Sterilizing Box
320x120 mm



2970
Instruments Tray



2971
Instruments Tray



2972
Instruments Tray
(Perforated)



2973
Instruments Tray
Shallow(Mayo)



2974
Scaler Tray
20.0 x 10.0 x 1.5 cm



2975
Scalers Tray



2976
Scalers Tray



2982
Spitten Mug



2983
Spirit Burner With Wick
Stainless Steel 18/10
Capacity: 150 ml, 60 ml



2984
Spirit Burners With Wick
Stainless Steel 18/10
Capacity: 70ml



2985
Dressing Jar



2986
Dressing Jar



2987
Irrigator (Douch Can)



2988
Measuring Jug



2989
Sponge Bowl



2990
Wash Basin
300mm-350mm-400mm



2994
Kick Bucket With Trolley



2991
Sponge Bowl



2992
Gallipot



2993
Medicine Cup



2995
Kidney Tray Shallow
150mm-200mm-240mm-300mm



2996
Kidney Tray Without Lid
150mm-200mm-250mm-300mm



2997
Kidney Tray With Lid
150mm-200mm-250mm-300mm

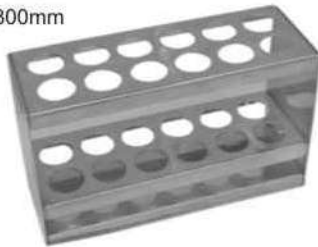

2998
Tube Rack, Stainless Steel 18/10



2999
Needle Case Rectangle
Needle Case Round With Cover
90x15



3000
Dustbin Without Stand
6-10-12 Ltr



3001
Tube Rack, Round Model
Stainless Steel 18/10



3002
Dustbin Without Stand & Cap
6-10-12 Ltr

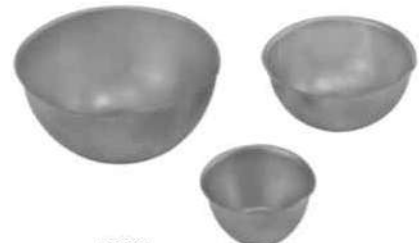

3003
Lotion Bowl With Lip
40-60-80-100-120-150-180-200mm



3004
Standard

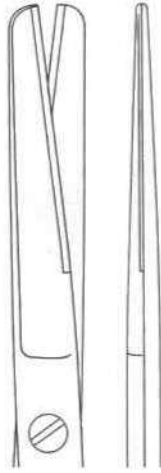

14,5cm
16,5cm
18,5cm



3005
Standard

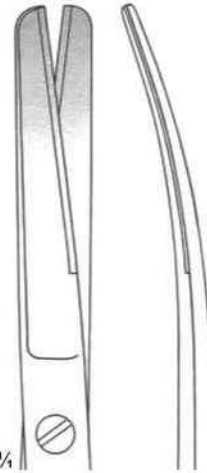

14,5cm
16,5cm
18,5cm



3006
Standard

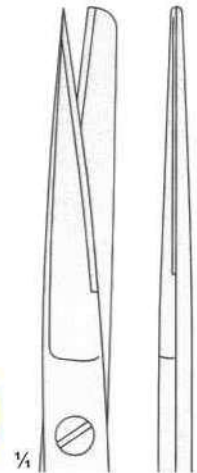

14,5cm
16,5cm
18,5cm



3007
Standard

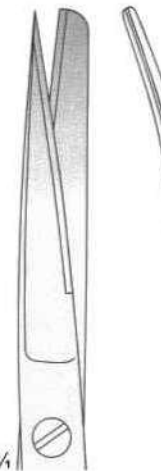

14,5cm
16,5cm
18,5cm



3008
Standard

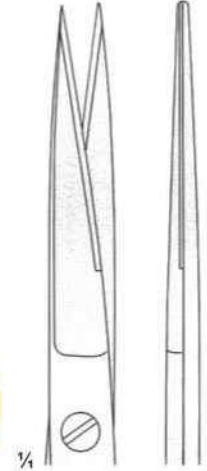

14,5cm
16,5cm
18,5cm



3009
Standard

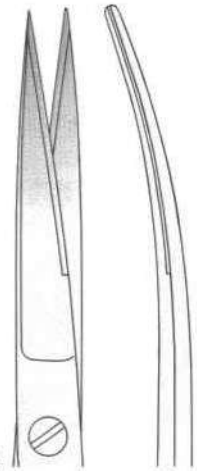

14,5cm
16,5cm
18,5cm

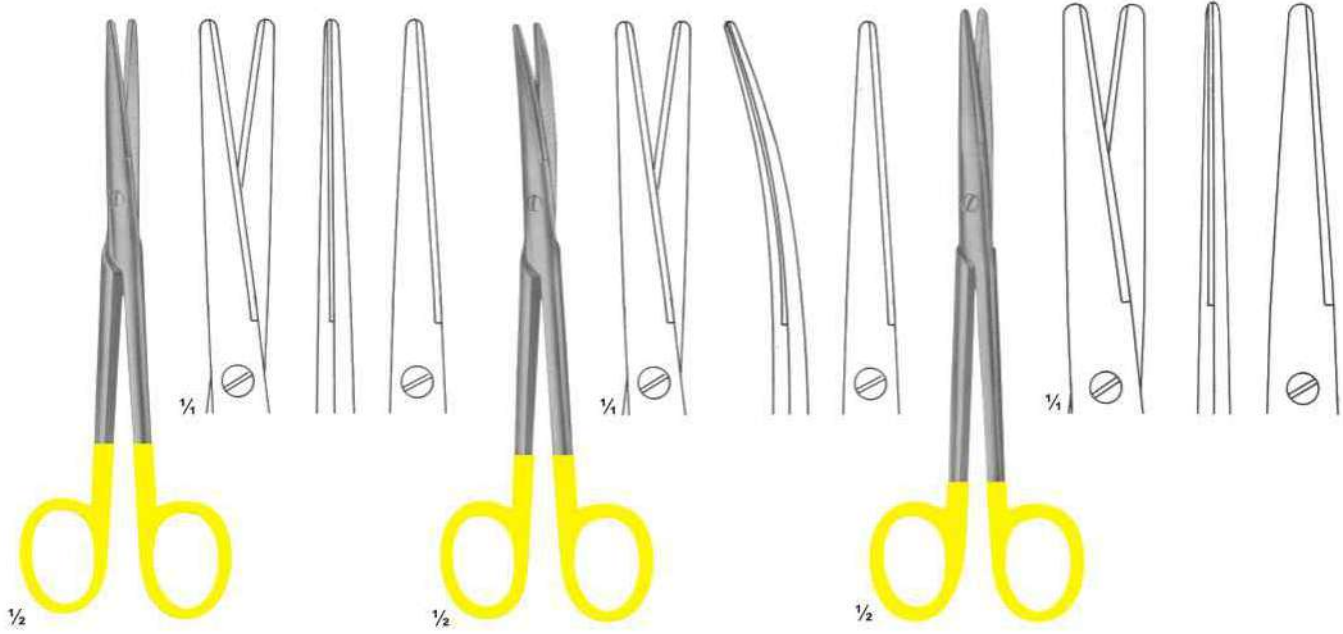

3010
MAYO-LEXER
Straight
16 cm

3011
MAYO-LEXER
Curved
16 cm

3012
LEXER
Straight
16, 21 cm

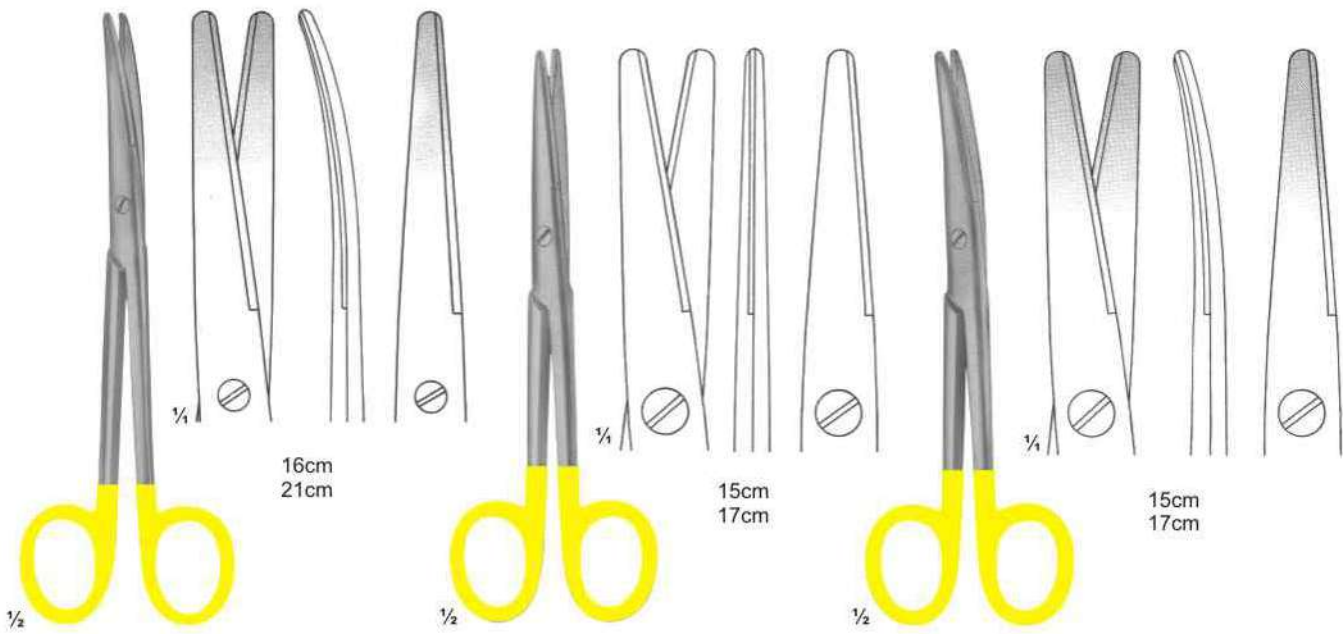

3013
LEXER
Curved
16, 21 cm

3014
MAYO-STILLE
Straight
15, 17 cm

3015
MAYO-STILLE
Curved
15, 17 cm



18cm 11,5cm
20cm 14,5cm
28cm 23,5cm
30cm 25,5cm

3016
METZENBAUM
Straight

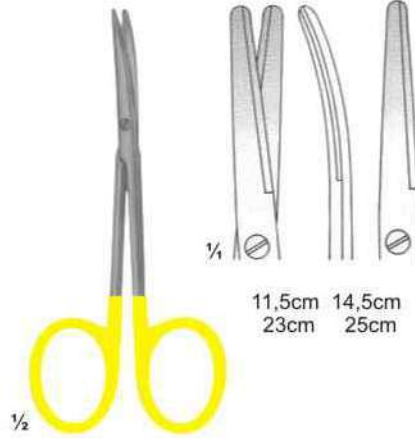

11,5cm 14,5cm
23cm 25cm

3017
METZENBAUM
Curved

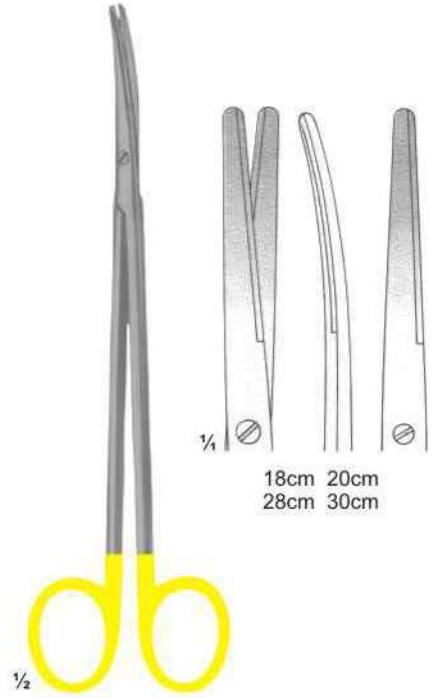

18cm 20cm
28cm 30cm

3018
METZENBAUM
Curved



14cm 18cm 20cm
23cm 25cm 28cm

3019
METZENBAUM FINO
Straight



14cm 18cm 20cm
23cm 25cm 28cm

3020
METZENBAUM FINO
Curved

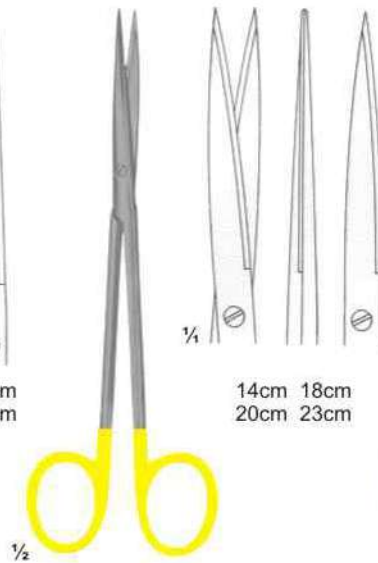

14cm 18cm
20cm 23cm

3021
METZENBAUM FINO
Sharp

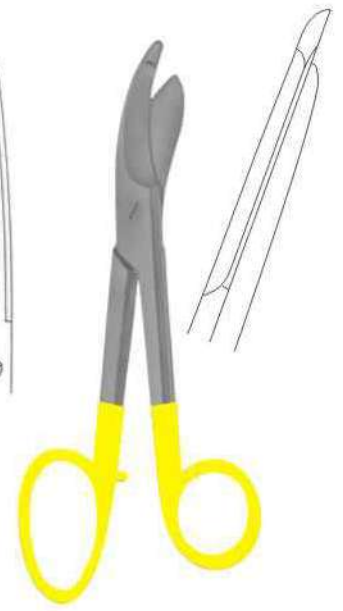

3022
BRUNS
235 mm

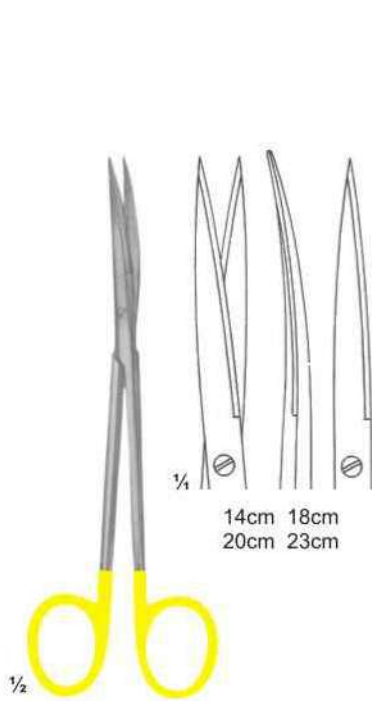

3023
METZENBAUM FINO

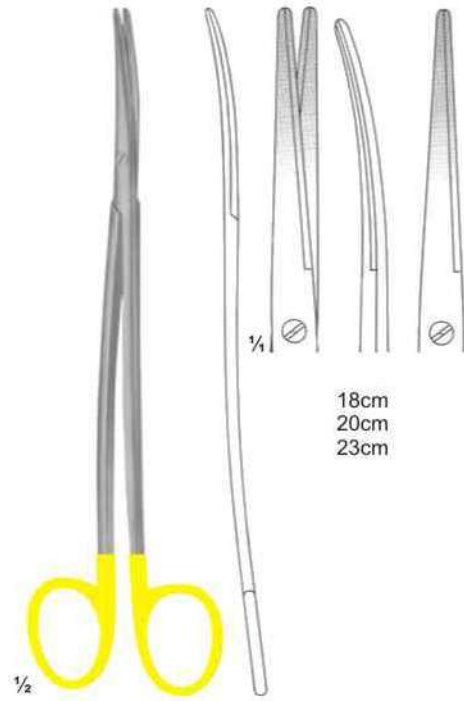

3024
METZENBAUM FINO

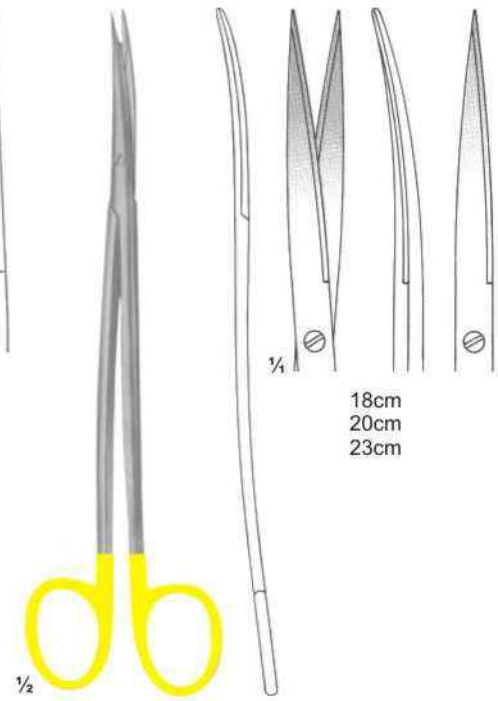

3025
METZENBAUM FINO

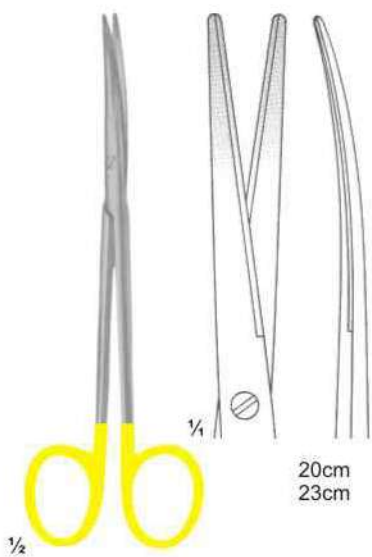

3026
METZENBAUM FINO

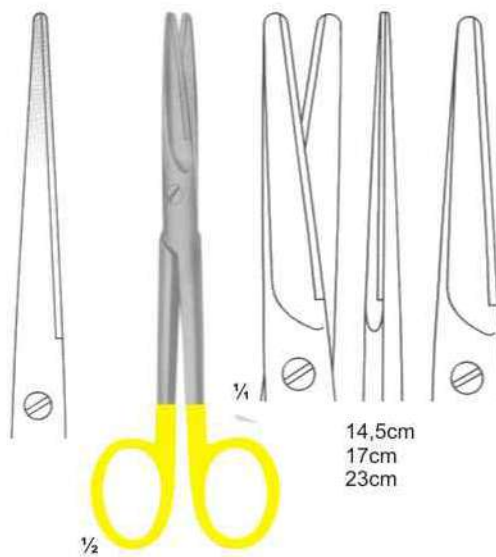

3027
MAYO
Straight

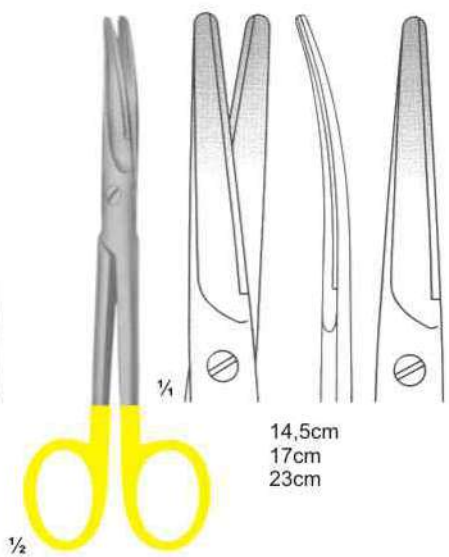

3028
MAYO
Curved

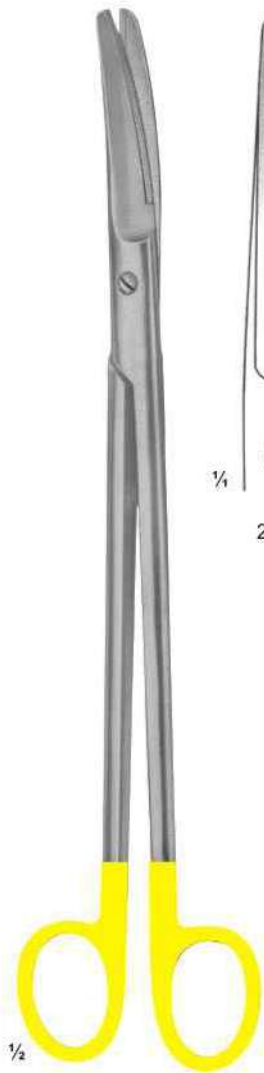

3029
SIMS

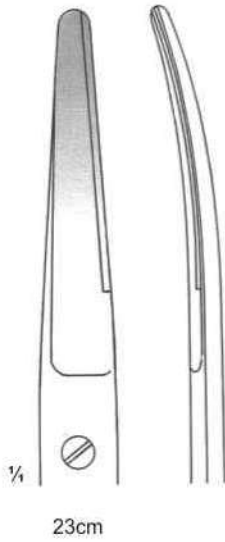

23cm

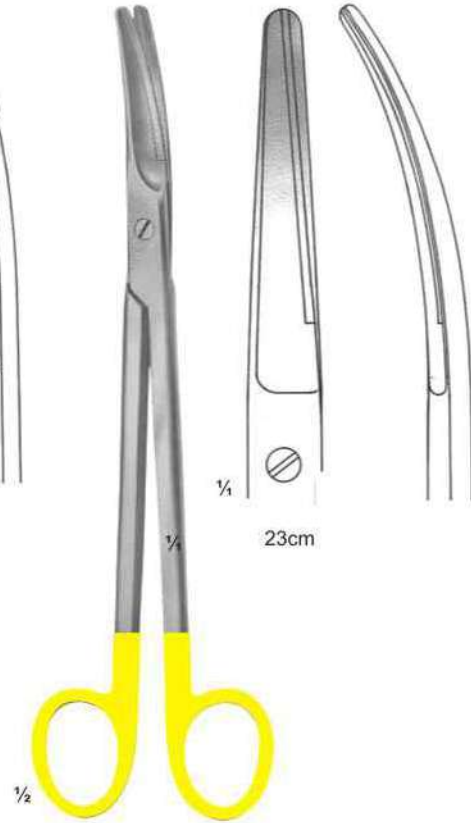

3030
PARAMETRIUM

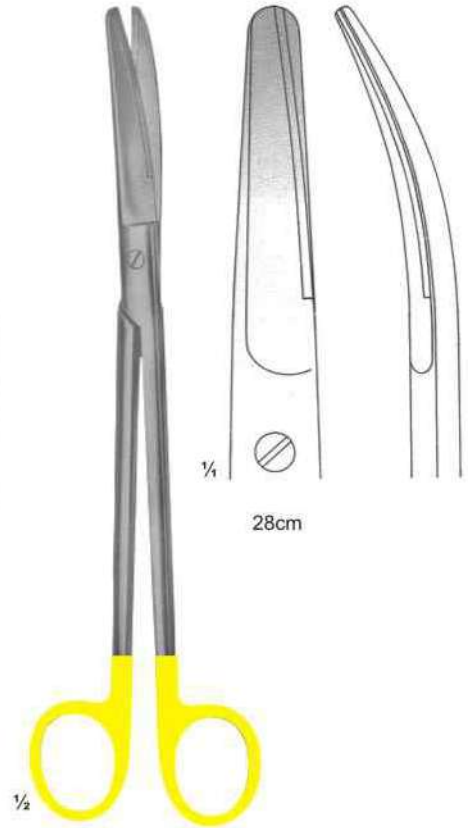

3031
MAYO-HARRINGTON



3032
KELLY
Straight 16 cm



3033
KELLY
Curved 16 cm



3034
DEAN
17 cm



3035
LAGRANGE
Double-Curved
11.5 cm



3036
DE-BAKEY



3037
DE-BAKEY

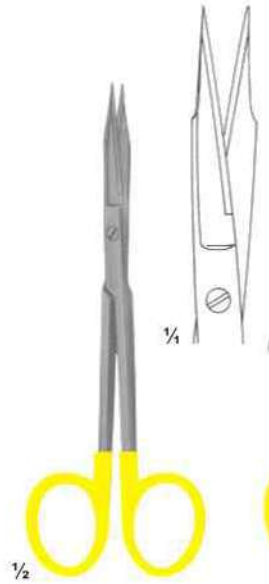

3038
GOLDMAN FOX
13 cm



3039
GOLDMAN FOX
Double-Curved
13 cm

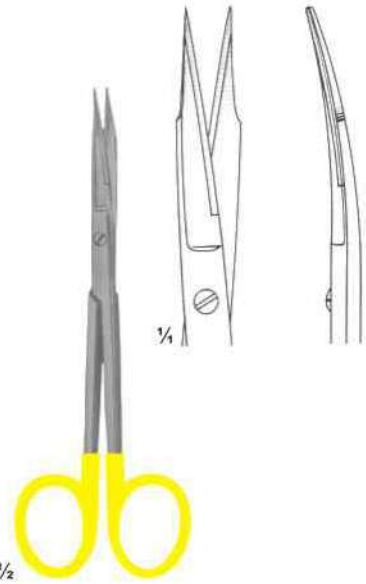

3040
GOLDMAN FOX
13 cm

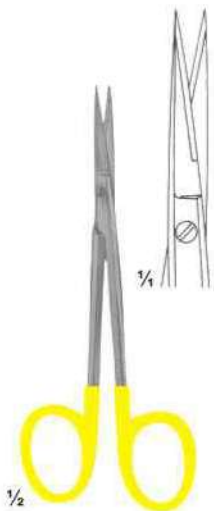

3041
Fine Scissors
Straight
11, 5 cm

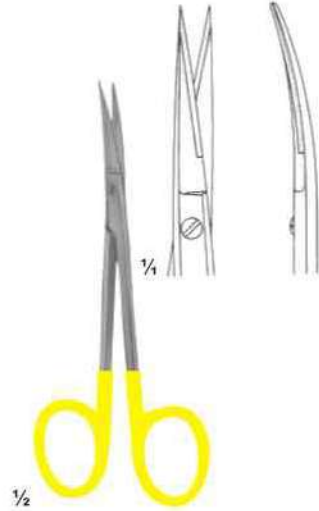

3042
Fine Scissors
Curved
11, 5 cm

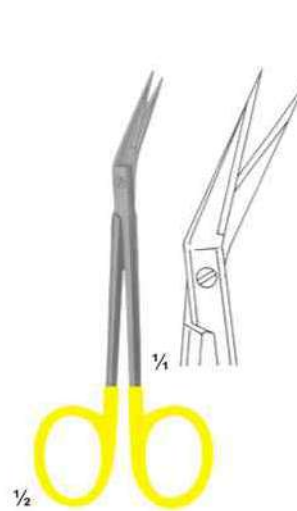

3043
Fine Scissors
Angled
11, 5 cm

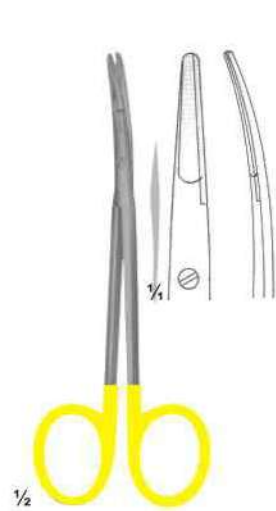

3044
RAGNELL
Curved
12 cm

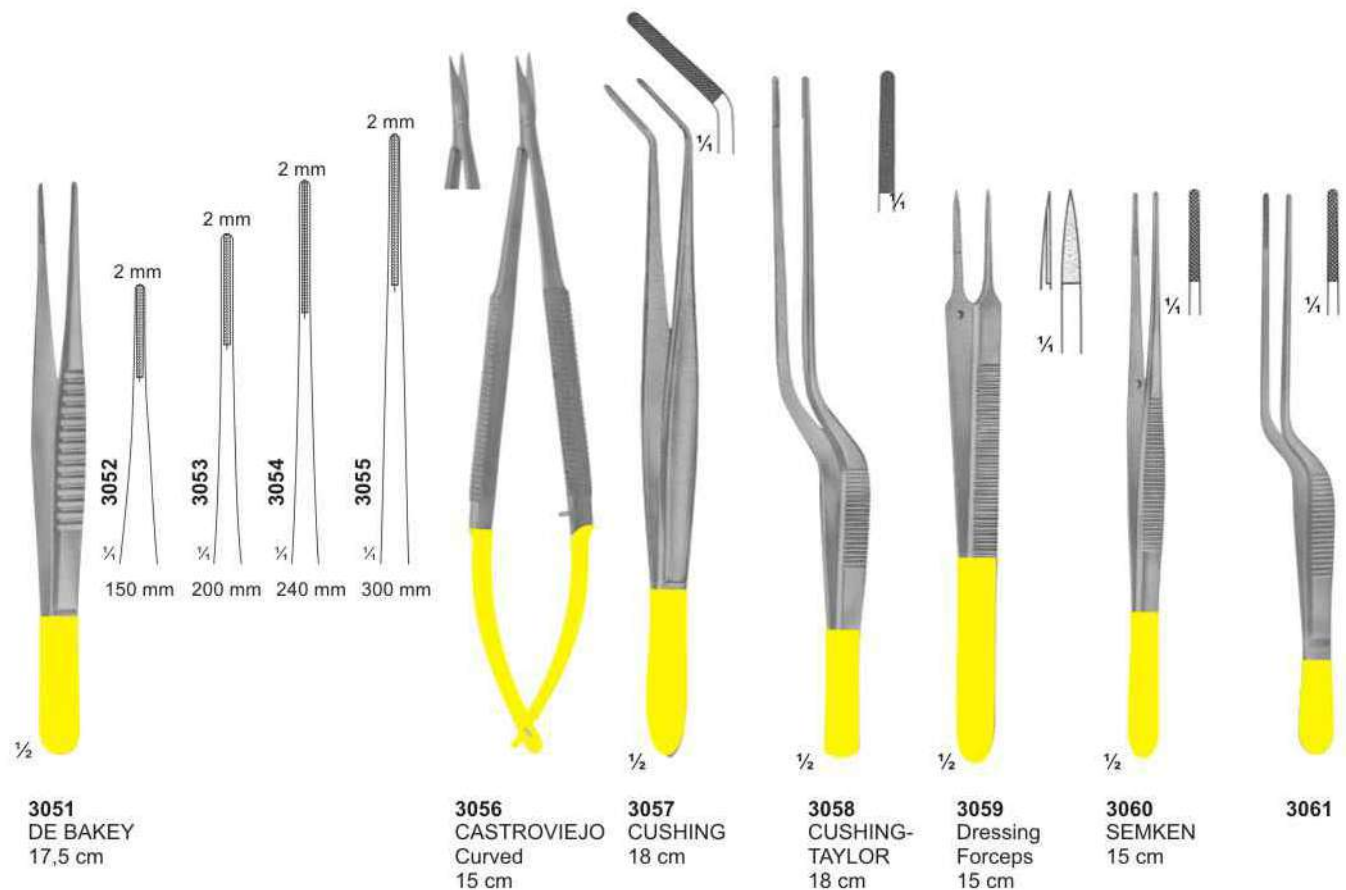
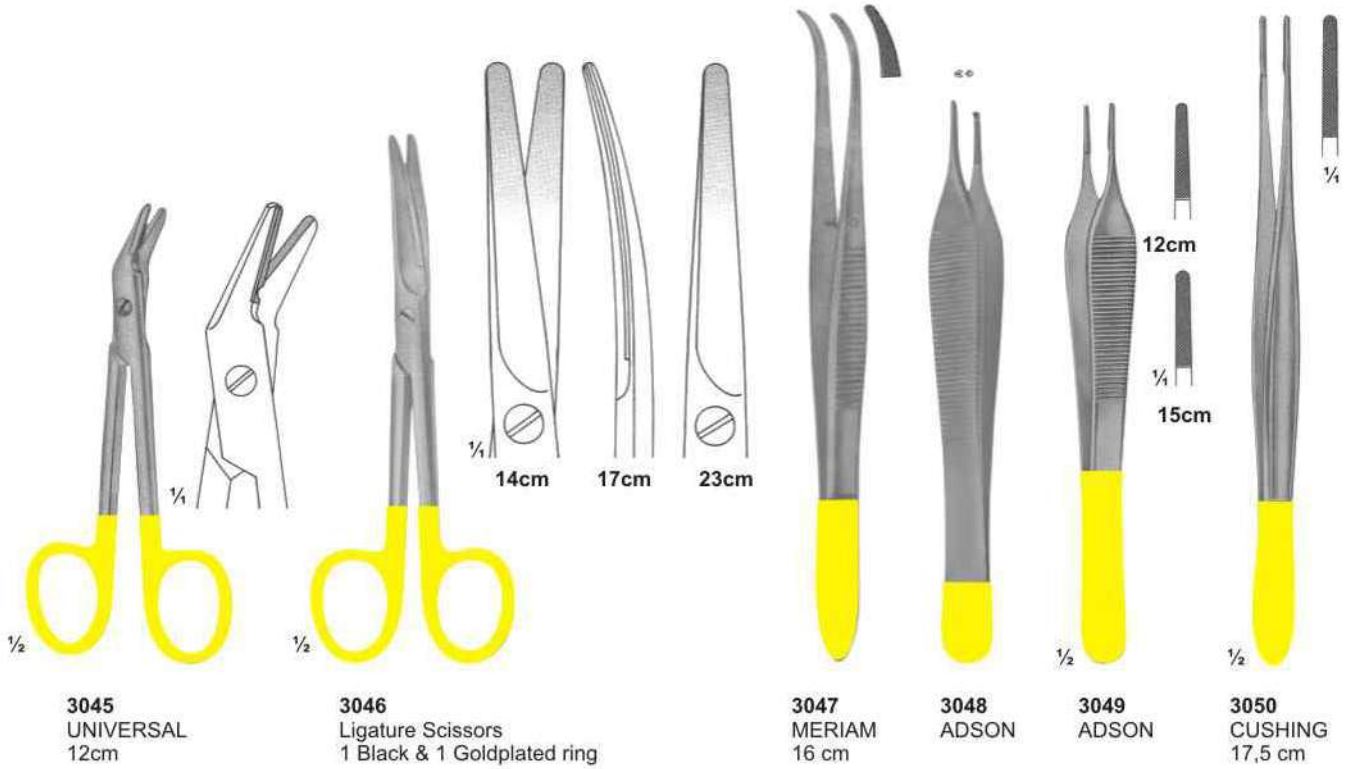

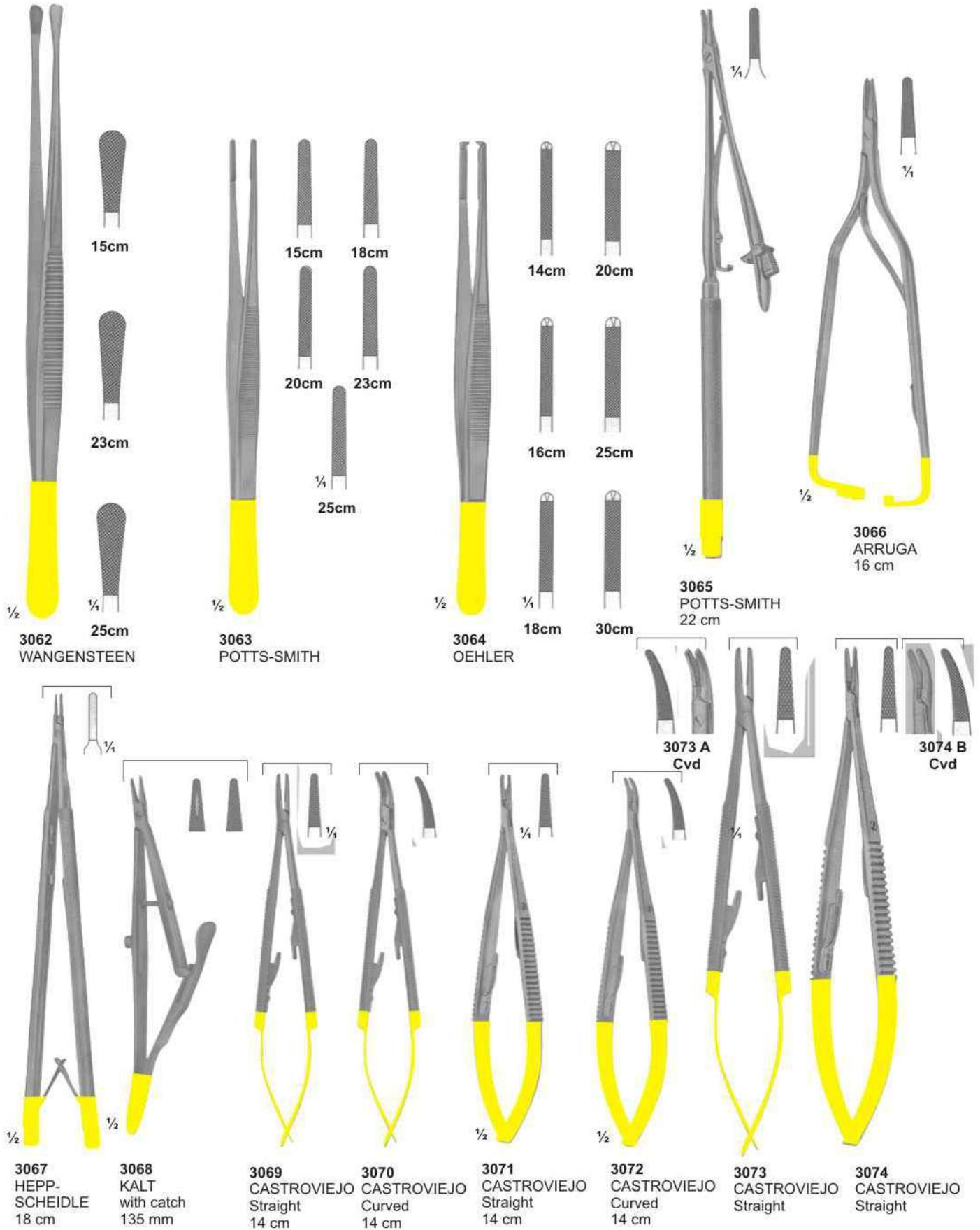

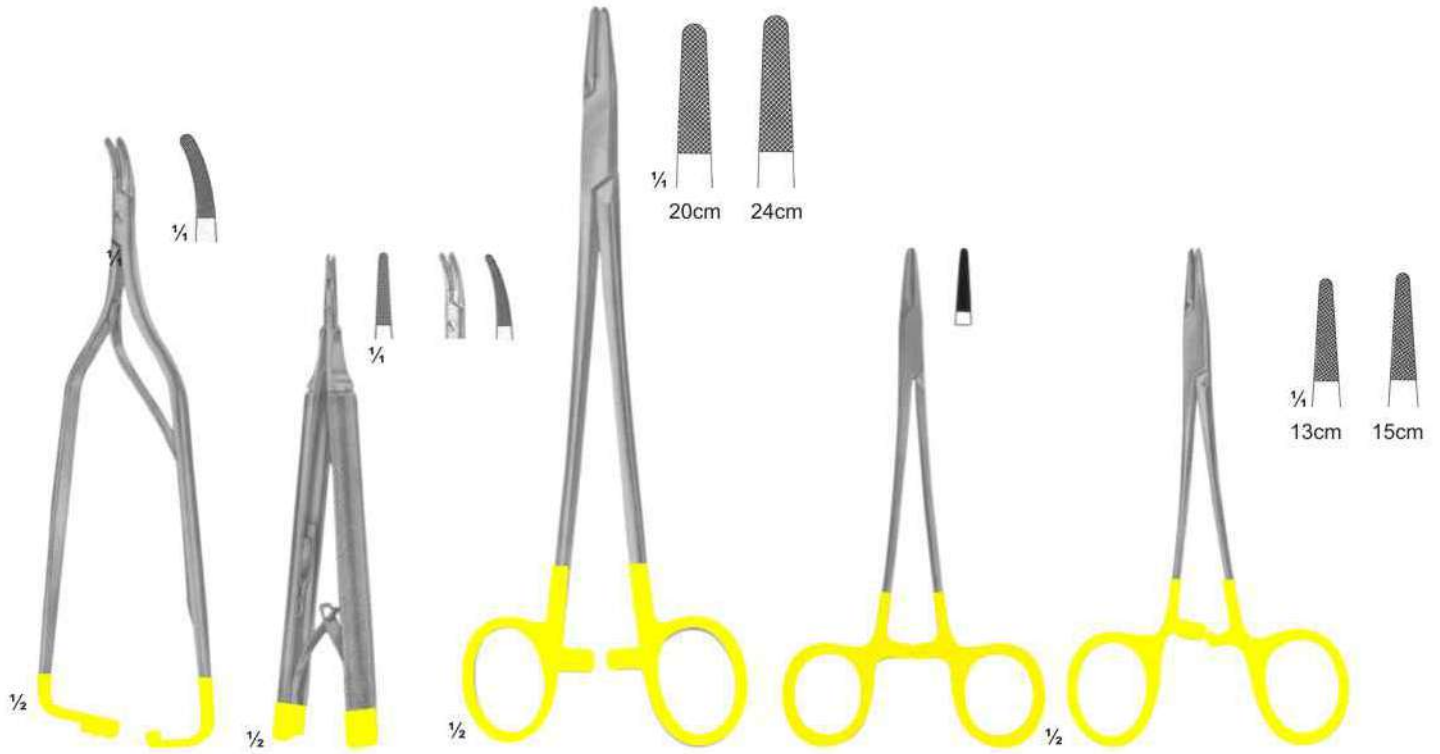

3075
ARRUGA
Curved
16 cm

3076
CASTROVIEJO
13 cm

3077
HEGAR
20,24 cm

3078
SMOOTH TIP
15 cm

3079
HALSEY
13,15 cm

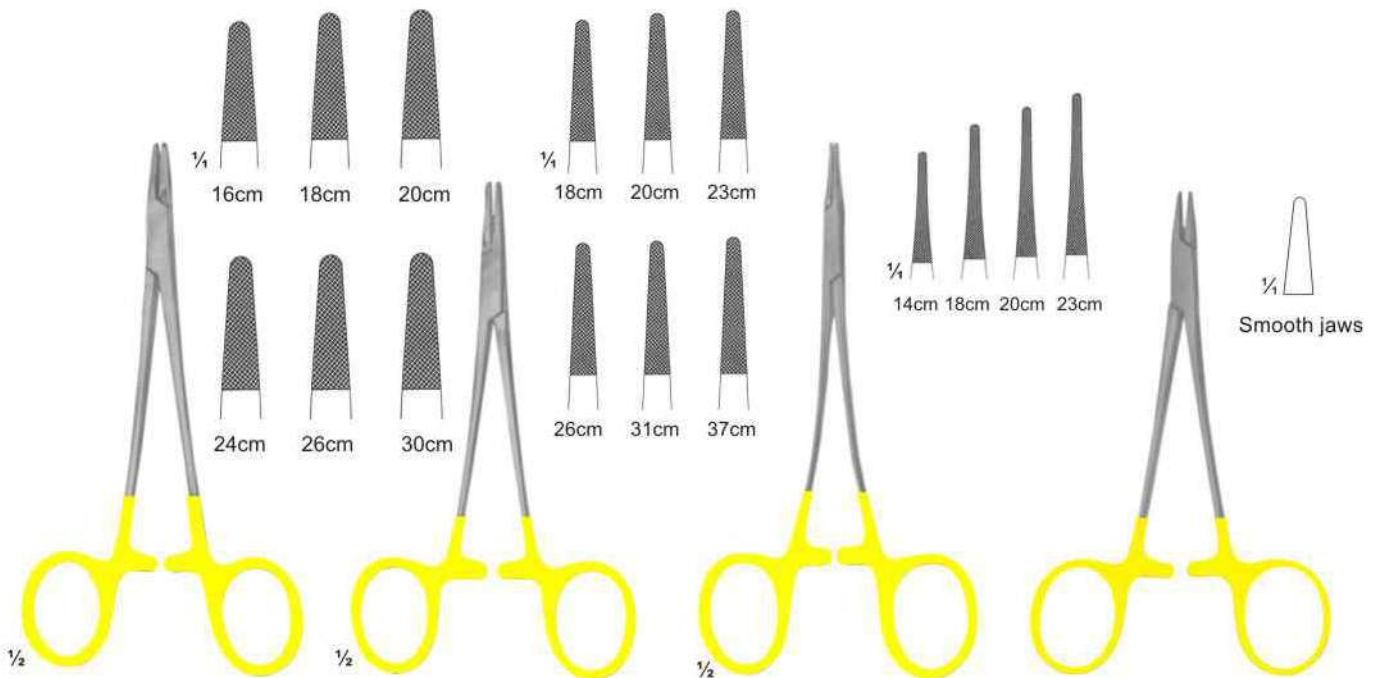

3080
MAYO-HEGAR

3081
DE BAKEY

3082
HEGAR-VASCULAR

3083
WEBSTER
125 mm

Needle Holders With Tungsten Carbide Inserts

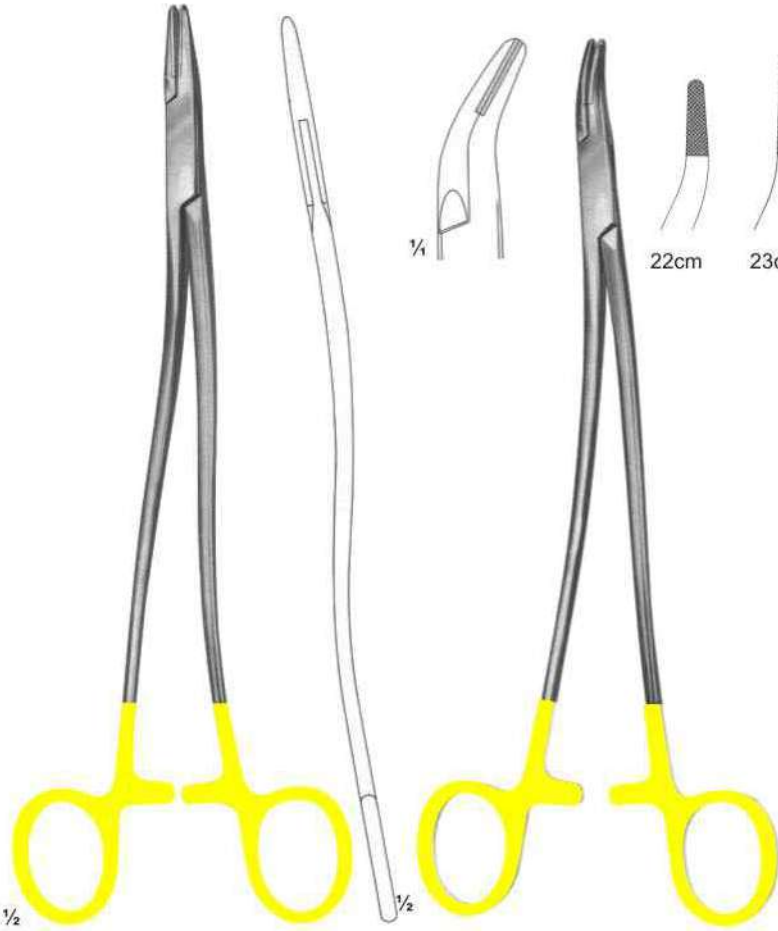

3084
BOZEMANN-WERTHEIM
20, 24, 26 cm

3085
STRATTE

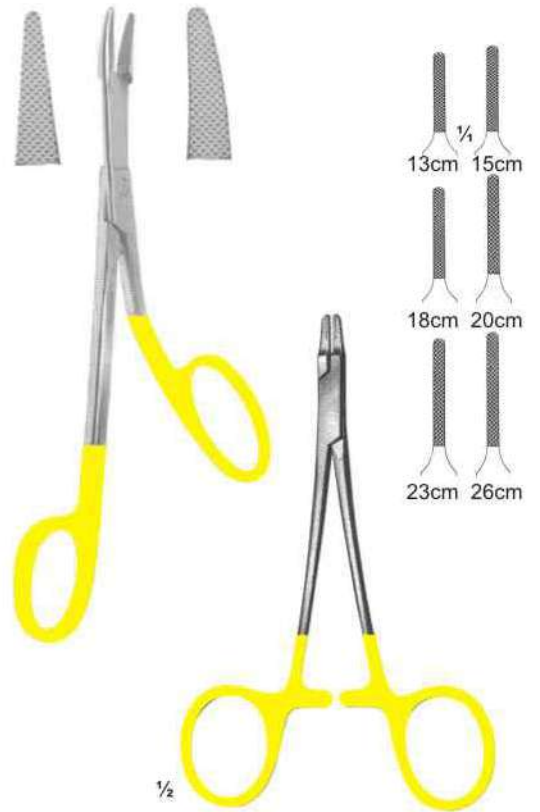

3086
RYDER

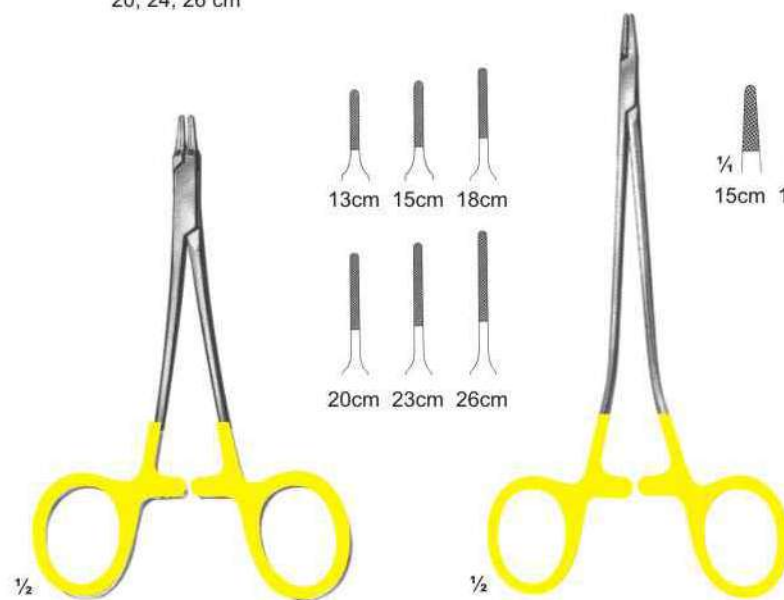

3087
RYDER-VASCULAR

3088
MARTIN

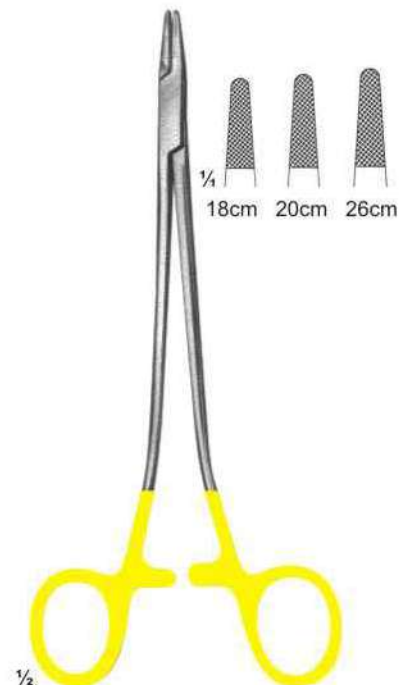

3089
SAROT

Needle Holders With Tungsten Carbide Inserts

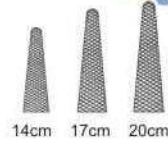

3090
FINOCHIETTO
27 cm

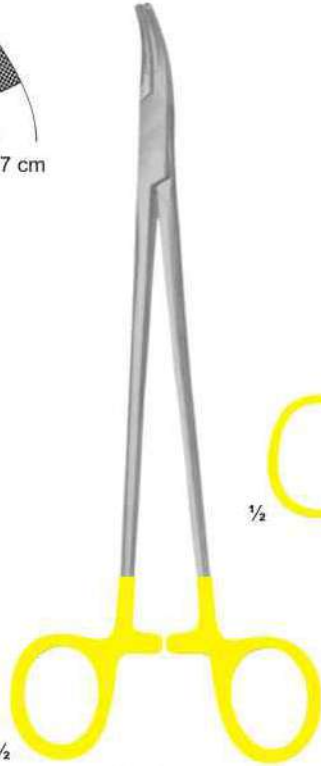

3091
HEANEY
27,24 cm



3092
BAUMGARTNER
145 mm



3093
CRILE-WOOD
15 cm



3094
MATHIEU
17,20 cm



3095
MATHIEU
14,17,20 cm



3096
MATHIEU-KOSHER
14,17,20,24 cm



3097
MATHIEU-KOSHER
17,20,24 cm



3098
MATHIEU-VASCULAR
17,20,24 cm



3099
MATHIEU-VASCULAR
Hosel
17,20 cm



3100
MATHIEU-RYDER
17,20,24 cm



3101
Hosel
Curved
20 cm



3102
LICHTENBERG
20 cm



3103
LANGHALS
20,25 cm



3104
LICHTENBERG
20,25 cm



3105
LUEHTY-BECK
20,25 cm



3106
LUEHTY-BECK
20,25 cm



3107
LANGENBECK
18,20,23 cm

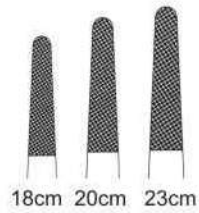

3108
LANGENBECK
18,20,23 cm



3109
TOENNIS
Elastic pattern for
dura-or intestinal suture
180 mm

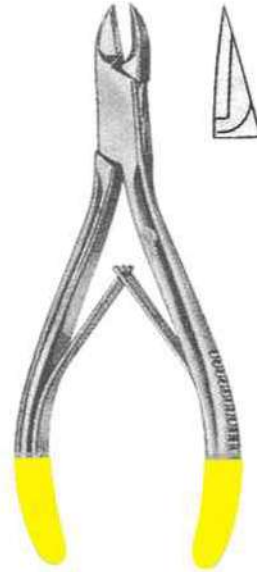

3110
Cutting Plier
12 cm

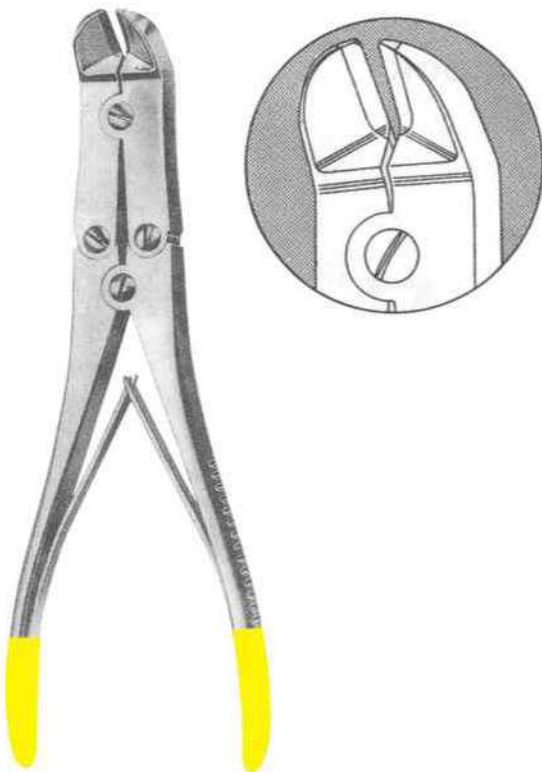

3111
MULLAR CLAUS
22 cm

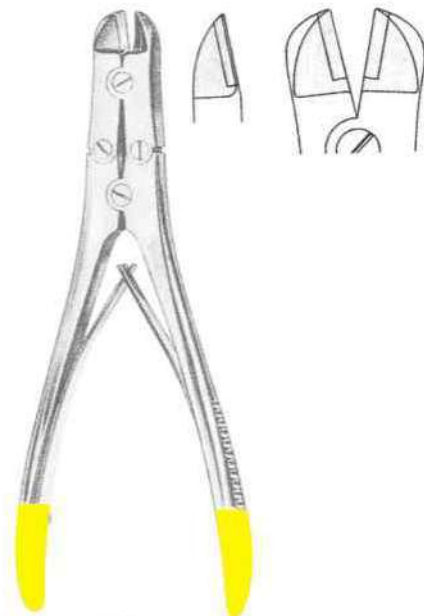

3112
Plier
17.5 cm



3201
Root Elevator



3202
Root Elevator



3203
Osteotomes
Pointed



3204
Osteotomes
Pointed



3205
Osteotomes Convex
Rounded Set of Five



3206
Luxator Set 7 Pcs

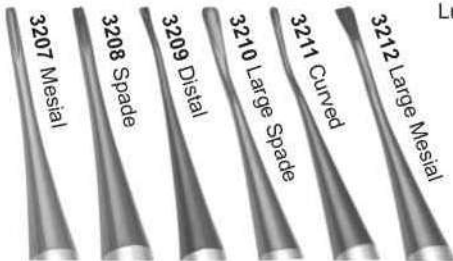

3213
Periodontal chisel
5mm / 3mm



3214
Sinus lift # 1
Set of Five

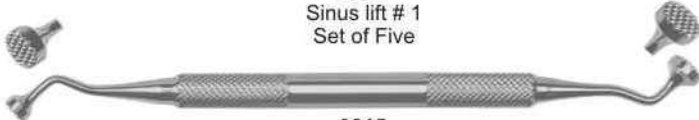

3215
Large Bone Packer
Serrated 5mm 7mm



3216
Labanca



3217
Sinus lift instruments



3218
Sinus lift instruments



3219
Replacement blade bone scraper
(curved) Three Type



3220
Adjustable-angle
Scalpel Blade Handle



3221
Replacment Blade
Bone Screper (streight)



3222
Bone Tamper 4mm
Searted Tip



3223
Bone Chisel



3224
Double Ended
Explorer



3225
Scaler



3226
Scaler



3227
Scaler



3228
Scaler



3229
Frazier Suction tube
2.5 mm diameter



3230
luxator set 7 pcs
mesial curved



3231
luxator set 7 pcs
mesial curved



3232
Bone Grafting
Syringe



3233
inter-ligmental
Syringes



3234
inter-ligmental
Syringes



3235
Adjustable Torque
Wrench



3236
Mucotomes
(straight)



3237
Bone Miller

3238
Bone Well



3239A
3239
Implant Torque Wrench with
Hex Rivet Nut 1.25 mm

3239B
3239C **3239D**
Drill Bits



3240
Fig. 1 / Hemingway



3241
Fig. 2 / Hemingway



3242
Fig. 3 / Hemingway



3243
Fig. 3

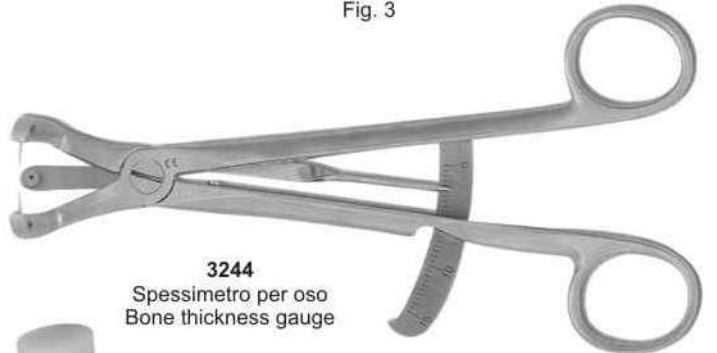

3244
Spessimetro per oso
Bone thickness gauge



3245
MALLET



3246
Dental implant fixture
removal kit

>trepines
>drivers
>end cutters

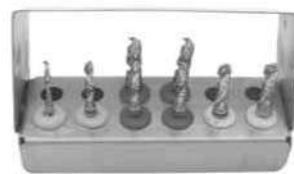

3247
Dental Trepine Drills
Set of Seven



3248
Dental Trepine Drills
Set of Ten



3249
Set of 8 Pcs



3250
Set of 5 Pcs



3251
Set of 5 Pcs



3252
Set of 7 Pcs



3253
Tooth Extracting Forceps Kit (Set of 12 pcs)
Fig #: 1,7,13,17,18,51A,67A,73,74N,86,89,90



3254
Pedo Forceps Kit (Set of 7 pcs)
Fig #: 560,561,562,563,565,566,567

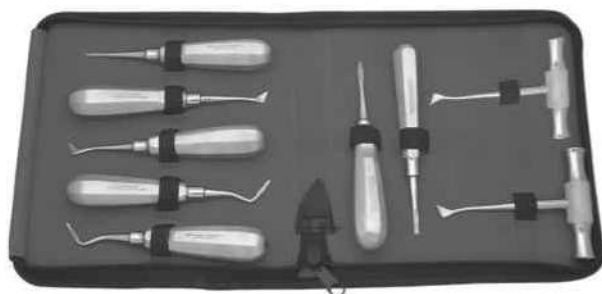

3255
Root Elevators Kit (Set of 9 pcs)
A) Cross Bar Elevator #775/7
B) Cross Bar Elevator # 775/8
C) Elevator, Str. Hospital Pattern (Semi-Pointed)
D) Elevator-Coupland Back Crurver #2 (Lindoleven)
E) Elevator # 720/10
F) Elevator # 120/11
G) Elevator # 720/27
H) Elevator # 720/28



3256
Oral Surgical Instruments Kit
A) B.P. Handle # 3 - Round, Str.
B) Artery Forceps, Str. 5.5"
C) Needle Holder, Str. 6"
D) Gum Scissors # 1
E) Gum Scissors # 2
F) Moons Probe, (Flat Beak)
G) Bone Curettes # 780 (Lucas)
H) Bone Nibbler, Large with Hole
J) Periosteal Elevator



3257
Crown Remover Set
Full Automatic



3258
Rubber Dam
Instruments Set



3259
Gracey Curettes, (Set of 8 pcs)
Fig # 1/2,3/4,5/6,7/8,9/10,
11/12,13/14,15/16



3260
Subgingival Scalers
(Set of 8 pcs S/E)



3261
Titanium Coated Filling Instruments
Hollow Handle (Set of 6 pcs)



3262
Titanium Coated Filling Instruments
(Set of 6 pcs)

A

Adams, Pliers	174
Aderer, Pliers	174
Adson, Forceps	158,207
Adson, Tweezers	151
Ainsworth, Rubber Dam Punch	147
Albee	143
Albrecht, Tweezers	155
Allen, Tweezers	155
Allis, Tissue Forceps	158
Amalgam Applicators	97
Amalgam Condensers	97
Amalgam Pluggers	97
Amalgam Carriers	145
Amalgam Guns	145
Andresen, Pliers	175
Andrews, Tongue Depressor	160
Angle, Pliers	169,174
Apical, Elevator	57,63
Arruga, T.C. Needle Holder	208,209
Articulators	194-195
Aspirating Syringes	149
Allen 9A, Elevator	50

B

Baby-Allis, Tissue Forceps	158
Band Removing Pliers	170
Bane, Rongeurs	179
Barnhart, Curettes	110,116
Barry, Elevator	66,69
Baum Gartner, Needle Holder	180,211
Bee Be, Scissors	186
Bein, Elevator	54,61
Beyer, Rongeurs	179
Bird Beak Pliers	167
Blumenthan, Rongeurs	176
Boley Gauge	143
Bone Curettes	129
Boynton, Needle Holder	181
Bozemann-Wertheim, T.C. Needle Holder	210
Bracket, Pliers	170
Brewer, Rubber Dam Instruments	147
Brown, Tissue Forceps	158
Brown-Adson, Tissue Forceps	158
Bruns, T.C. Scissors	203
Buchs, Retractor	162
Burnishers	99-100
Ball Chain	146
Boley Gauge,	143
Bone Gauge,	144
Bone Mill Forcep,	139
Bone Pluggers,	140
Bracket, Gauge	144
Buser, Elevator	52

C

Carvers	102,103
Castroviejo, Needle Holder	181,208,209
Castroviejo, scissors	186
Castroviejo, Gauge	144
Castroviejo, Sclerer Marker	144
Cement Instruments	118,119,121
Cement Spatulas	120,122
Chisels	103
Chompret, Elevator	63

Cleveland, Rongeurs	177,178
College, Tweezers	152,154
Collier, Needle Holder	180
Collin, Retractor	162
Columbia, Curettes	110,111,116
Composite Placement	104,105
Con Scodellino, Wax Knives	126
Cord Packers	95
Cottle, Scissors	184
Coupland, Elevator	58
Crane-Kaplan	128
Crile, Forceps	157
Crile, Needle Holder	181
Crile-Wood, Needle Holder	180
Crown Instruments	135,136
Crown Removers	134,135
Crown Shell, Pliers	166
Cryer, Elevator	55,58,69
Cushing , T.C. Forceps	207
Cushing, Tweezers	151
Cushing-Taylor , T.C. Forceps	207

D

De Bakey , T.C. Forceps	207
De Bakey, Scissors	184,186,206
De Bakey, T.C. Needle Holder	209
De La Rosa, Pliers	169
Deaver, Scissors	184
Denhart, Mouth Gag	160
Dental Implants Instruments	214,216
Dental Instruments Sets	217
Derf, Needle Holder	180
Disposable Products	117
Dr.Sader, Elevator	69
Dressing Forceps	207
Dean Scissors	186,205

E

Elevators	51
Endodontic Condensers	86,87
Ernert, Wax Knives	126
Excavators	89-91
Explorers	80-82,91-94
Extracting forceps (American Pattern)	36-49
Extracting forceps (English Pattern)	1-24
Extracting forceps (fitting handle)	25-33
Extracting forceps (For Children)	34

F

Fahnenstock, Wax Knives	126
Files	125
Filling Instruments	106,107
Fine, T.C. Scissors	206
Finocchio, T.C. Needle Holder	211
Finocchio, T.C. Needle Holder	211
Fischer, Pliers	175
Flagg, Tweezers	154
Flohr, Elevator	56
Fomon, Tissue Retractor	164
Freer, Elevator	52
Friedman, Rongeurs	178
Furrer, Pliers	174
Film Hanger	146
Finger Cup	197
Flohr, Elevator	57
Freer	15,16

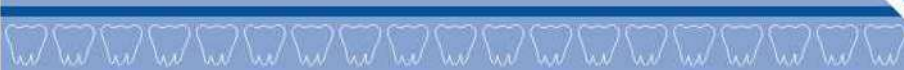

Elevator	52	Langenbeck, Retractor	162
G		Langenbeck, T.C. Needle Holder	212
Gardner, Bone Chisels	132	Langer, Curettes	110,116
Gardner, Needle Holder	180	Langhals, T.C. Needle Holder	212
Gardner, Rongeurs	178	Lecluse, Elevator	65
Gillies, Hook	164	Lessmann, Wax Knives	126
Gillies, Tweezers	151	Lexer, T.C. Scissors	202
Goldman Fox , T.C. Scissors	206	Lichtenberg, T.C. Needle Holder	212
Goldman Fox, Curettes	112,113	Ligature , T.C. Scissors	207
Goldman Fox 14, Elevator	50	Lip & Cheek Retractors	161,162
Goldman Fox, knives	114	Lister, Scissors	184
Goslee, Pliers	175	Littauer, Scissors	186
Gracey Curettes	108,109,116	Littler, Scissors	184
H		Locklin, Scissors	186
Halsey, T.C. Needle Holder	209	London Hospital, Elevator	62
Handles	72	London-College, Tweezers	154,155
Hartman, Rongeurs	179	Lucae, T.C. Forceps	
Hatchets	95	Luehty-Beck, T.C. Needle Holder	212
Heaney, T.C. Needle Holder	211	Lwanson, Crown Gauge	143
Hegar, T.C. Needle Holder	209	Lagrange, Scissors	186,205
Hegar-Vascular, T.C. Needle Holder	209	Littaure, Scissors	186
Heidbrink, Elevator	64,67,69	Lwanson, Crown Gauge	143
Heidbrink, Elevator	57	M	
Howard 9H, Elevator	52	Martin, T.C. Needle Holder	210
Height Gauge,	143	Mathieu, Needle Holder	181,211
Hepp-Scheidle, T.C. Needle Holder	208	Mathieu-Kosher, T.C. Needle Holder	211
Hlsted-Mosquito, Forceps	159	Mathieu-Ryder, T.C. Needle Holder	212
Hoes	95,125	Mathieu-Vascular, T.C. Needle Holder	211
Hollow Wares	196-200	Mayo Harrington, T.C. Scissors	205
How, Pliers	167,174	Mayo, Scissors	185,204
Howard, Bone Files	131	Mayo-Hegar, Needle Holder	181
Hylin, Elevator	61	Mayo-Hegar, T.C. Needle Holder	209
I		Mayo-Lexer, T.C. Scissors	202
Implants Instruments	137-141	Mayo-Stille, T.C. Scissors	202
Impression Trays	187-193	Mayo-Stille Scissors	185
Iris Scissors	183	Mc Kellops, Pliers	175
Ivory, Rubber Dam Instruments	147	Mccalls, Curettes	110,111,116
J		Mcindoe, Tweezers	151
Jarabak, Pliers	165	Mead, Bone Mallets	133
Jeseeph, Scissors	183	Mead, Elevator	64
Johnson, Pliers	169,175	Mead, Rongeurs	179
Joseph, Tissue Retractor	164	Meriam , T.C. Forceps	207
K		Meriam, Tweezers	153,155
Kalt, T.C. Needle Holder	208	Metzenbaum Fino, T.C. Scissors	203,204
Kelly, Forceps	159	Metzenbaum, Scissors	185,203
Kelly, Scissors	183	Micro Surgery Set	182
Kelly Scissors	205	Micro-Adson, Tweezers	151
Kim's Plier	165	Micro-Friedman, Rongeurs	178
Kirkland, knife	114	Middledorpf Retractor	162
Knives	125	Miller, Articulating Forceps	147
Knowles, Scissors	184	Miller, Bone Files	130
Kocher, Retractor	162	Mini-Blumenthan, Rongeurs	176
Kocher-Langenbeck, Retractor	162	Molt, Elevator	50
Kopp, Elevator	60,68	Molt, Mouth Gag	160
Kopp , Tweezers	151	Molt 9, Elevator	50
L		Morrison, Elevator	56
Lab & Office Pliers	166	Mouth Mirrors with Handles	73
Landgraf, Tweezers	154	MSY, Pliers	175
Langenbeck, Pliers	175	Mullar Claus, Wire Cutting Pliers T.C.	213
		N	
		Nance, Pliers	168,169,174
		Napkin Holders	146
		Neivert, Needle Holder	180
		Nelson-Metzenbaum, Scissors	185
		Non Chill	146

O			
O'Brien, Pliers	168	Spreaders	87
Obturation Instruments	88	Split Chisels,	128
Ochsenbein	128	Spring Bow Divider	143
Ordan, knife	114	Standard, T.C. Scissors	201
Oehler, T.C. Forceps	208	Standard, Tweezers	151
Olsen-Hegar, Needle Holder	180	Steiner, Pliers	166
Optical Pliers	168	Sterilizing & Lab Instruments	156
Orthodontic Cutters, T.C.	172	Sterilizing Forceps,	163
Orthodontic Distal & Cutters	173	Stevens, Needle Holder	181
Orthodontic Pliers, T.C.	171	Stevens, Scissors	183
Ott, Elevator	62	Stille, Scissors	185
P		Stratte, T.C. Needle Holder	210
Parametrium, T.C. Scissors	205	Strip Holder Clips	146
Partsch, Bone Chisels	133	Syringes	150
Partsch, Bone Mallet	133	Suction Tubes,	140,142
Pean, Forceps	157	Sugarman, File	114
Peeso, Pliers	166,175	T	
Peets, Forceps	157	Toennis, Wire Cutting Pliers T.C.	213
Perry, Tweezers	151	Toennis-Adson, Scissors	184
P.K. Thomas,	96,96	Toennis, Tissue Retractor	164
Pich,	98,98	Towel Clamps, Napkin Holders	159
Pluggers,	98,98	Tweed, Pliers	168
Prichard, Elevator	50,50	Telescope, Crown Plier	136
Plastic Handle Elevators	70	Traymann, Crown Remover	128
Polokoff, Bone File	131	U	
Pott, Elevator	51	Universal , T.C. Scissors	207
Potts-Smith, T.C. Forceps	208	Universal, Pliers	174
Potts-Smith, T.C. Needle Holder	208	Universal, Elevator	135
Probes	82-85,91,94	Utility Plier	165
Q		V	
Quinby, Scissors	183	Vernier, Measuring Instruments	143
R		Vernier Gauge	143
Ragnell , T.C. Scissors	206	W	
Retainers, Bands	146	Wakefield, Bone Chisels	132
Reynolds, Pliers	169,174	Waldron, Pliers	174
Root Planning Curettes	115	Waldsachs, Pliers	174
Root splinter forceps	35	Wangensteen, T.C. Forceps	208
Roux, Retractor	162	Warwick-James, Elevator	62
Rubber Dam Clamps	148	Waugh, Tweezers	151
Rubber Dam Holder	147	Wax & Modeling Carvers	120
Rule, Curette	110	Wax & Plaster Knives	127
Russian, Tissue Forceps	158	Wax Carvers	101
Ryder, T.C. Needle Holder	210	Wax, Porcelain Instruments	118,119,121
Ryder-Vascular, T.C. Needle Holder	210	Webster, Needle Holder	180,209
S		Weingart , Utility Pliers	167
Sarot, T.C. Needle Holder	210	Weitlaner, Retractor	160
Scalers	75-79	West, Elevator	50
Scalpel Handles	71	White, Rubber Dam Instrument	147
Schwarz, Pliers	168,175	Wieder, Tongue Depressor	160
Schluger, File	114	Winter, Elevator	65,69
Seldin, Elevator	50,55,67	Wire & Clasp Bending Pliers	170
Select, Tweezers	151	Wire Bending Pliers	166
Semken, T.C. Forceps	207	West, Elevator	50
Semkin, Tissue Forceps	158	Wire Cutter	165
Senn, Tissue Retractor	164	Woodson,	98
Separating Pliers	166	Y	
Sims, T.C. Scissors	205	Young, Pliers	168,174
Spatulas	123	Z	
Spencer, Scissors	186	Zuricher, Measuring Instrument	143
Spencer-Wells, Forceps	157	Zuricher, Gauge	143

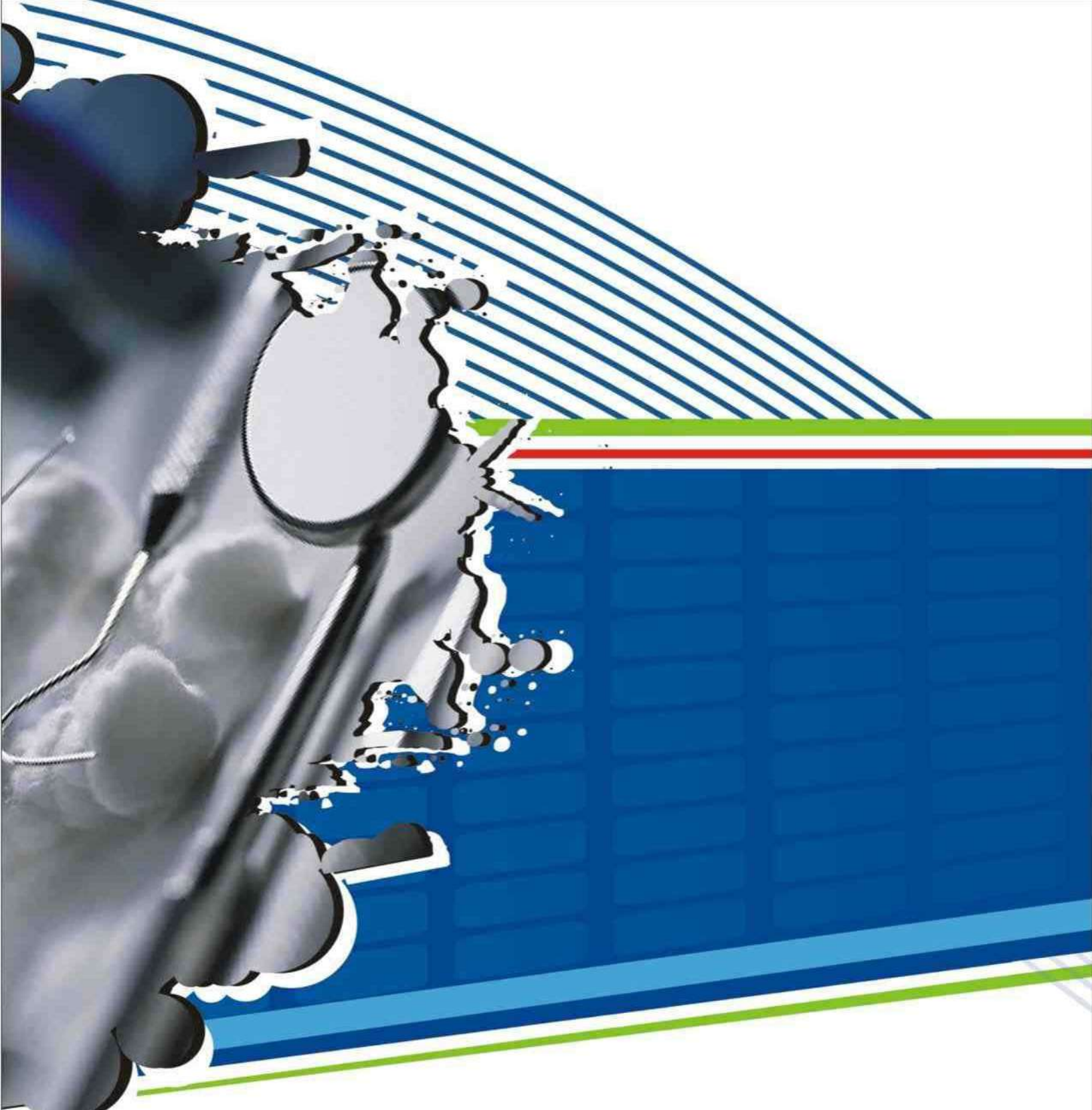

ES
ELIXIR SURGICAL



☎ : +966-56-5176399

☎ : +92-322-2182828

✉ : info@elixirsurgical.com

🌐 : www.elixirsurgical.com